

TRUX

ACCESSORIES

VOLUME 11
CATALOG



HEADLIGHTS | WORK LAMPS | LIGHTING
UNIVERSAL & WHEEL ACCESSORIES | FENDERS | EXHAUST | TRIMS



**CUSTOM
DISPLAYS**

ADD A **WOW** FACTOR TO YOUR SHOWROOM

WITH ONE OF OUR EXCITING CUSTOM DISPLAYS

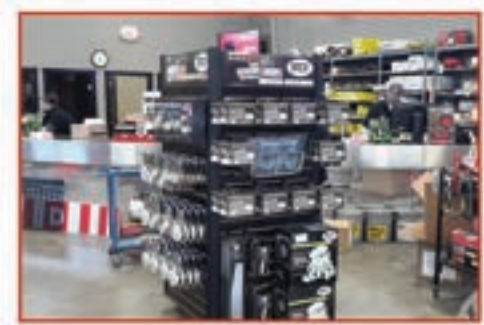

SLOTWALL

GONDOLA

MRD



WALL DISPLAYS

WANT TO ADD A WOW FACTOR TO YOUR SHOWROOM?

Trux has developed a questionnaire that identifies your every need. With this questionnaire your account manager will create a custom wall display tailored to your answers. From there, Trux will build a product diagram and a suggested order for you to approve.

FOR MORE INFORMATION SEE PAGE 324!

MRD DISPLAYS

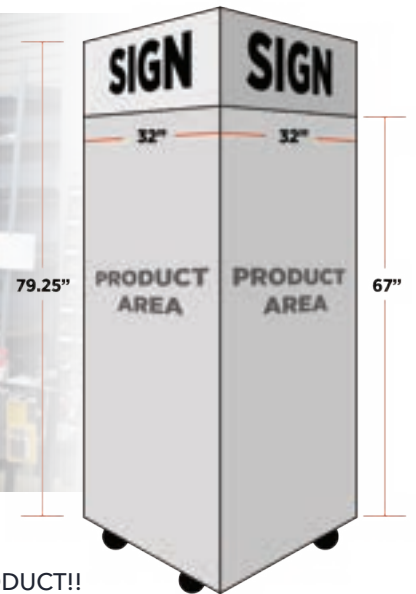

WANT TO SHOWCASE ALL YOUR ACCESSORIES BUT HAVE LIMITED SPACE?

Our Mobile Retail Display only takes 32" x 32" of floor space BUT provides 60 SQUARE FEET OF PRODUCT!!

FOR MORE INFORMATION SEE PAGE 322!

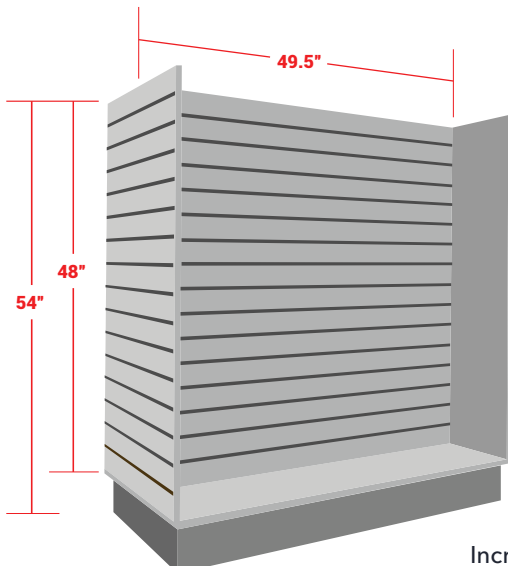

GONDOLA DISPLAYS



OPTIMIZE & INCREASE YOUR SALES

Increase your sales and optimize your retail space with Trux four-sided free-standing display by creating aisles of product and increasing exposure.

FOR MORE INFORMATION SEE PAGE 323!

TRUX'S

HEATED



**4" x 6" LED PROJECTOR
HEADLIGHTS WITH
HEATED LENS**

TLED-H12
LOW BEAM

TLED-H11
HIGH BEAM

DOT COMPLIANT ✓

QUICK HEAT TECHNOLOGY ✓
ACTIVATES AT 3°C (37.4° F)

7 YEAR WARRANTY ✓

SEE PAGE 11
FOR MORE INFORMATION

HEATED SERIES



BREATHABLE MATERIAL
WATER & WIND RESISTANT



MULTI-ZONE HEATING
UP TO 11* HOURS OF HEAT
*HEAT DURATION VARIES BASED ON JACKET MODEL



POWER BANK
RECHARGEABLE WITH USB



INCLUDED



STYLES & SIZES
UP TO 3 STYLES
(BOMBER, SOFT SHELL, SAFETY PARKA)



SIZES: M, L, XL, XXL

HEATED APPAREL

JACKETS
BOMBER, SOFT SHELL
& SAFETY PARKA

VEST
LINER

GLOVES & MITTS



SEE PAGE 293
FOR MORE INFORMATION

**FOR MORE
INFORMATION
SEE PAGE 27**

TLED-U118

TLED-U114

TLED-U112

LED WORK WITH



AGRICULTURAL



DELIVERY VEHICLES

PERFECT FOR A WIDE RA

CUTTING EDGE TECHNOLOGY

WORK SMARTER, NOT HARDER

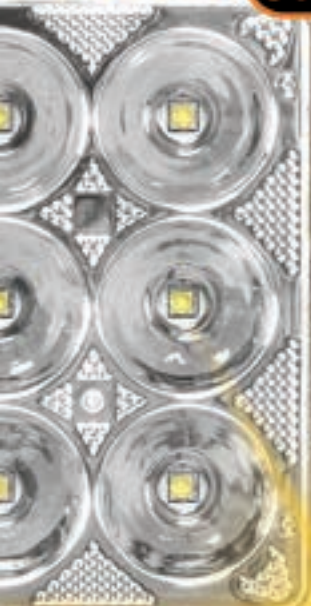

TLED-U106



TLED-W4



WORK LAMPS STROBE



SERVICE VEHICLES



WRECKERS

RANGE OF APPLICATIONS

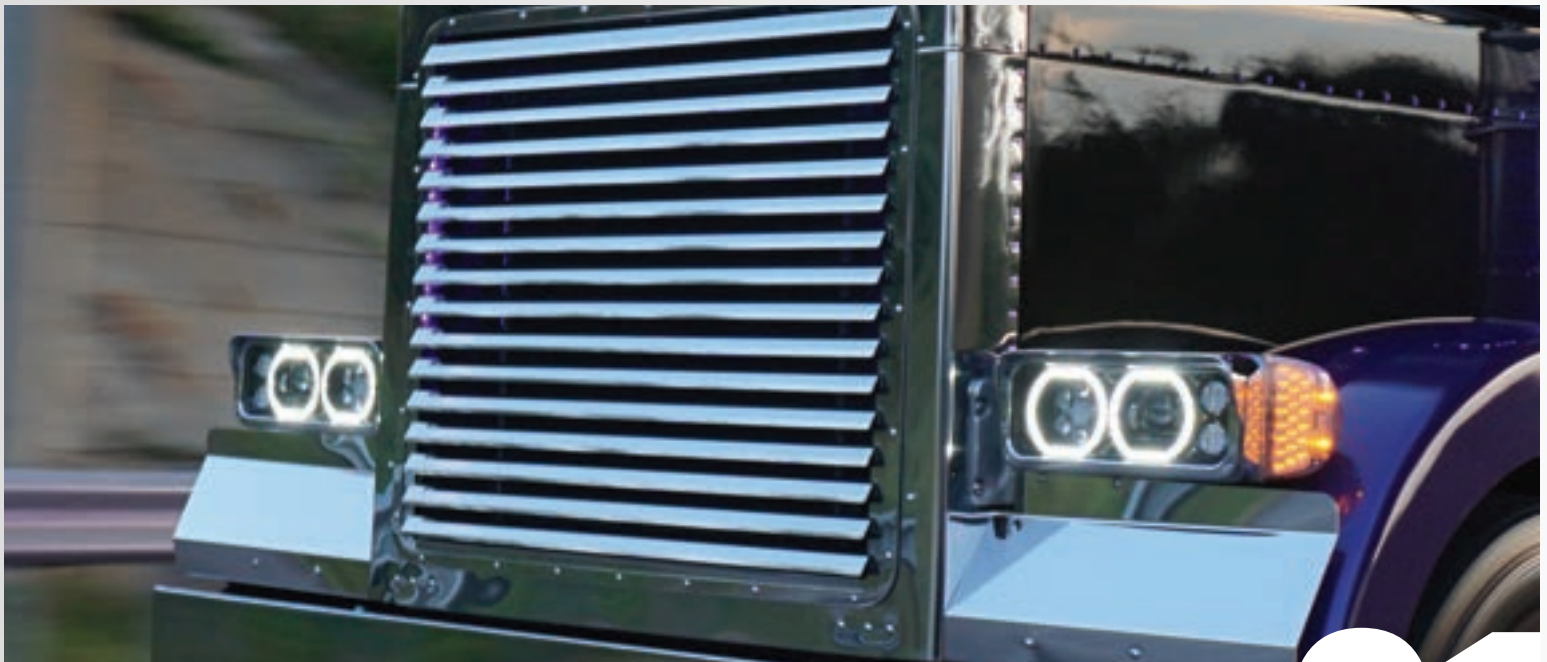

UNIVERSAL LED PROJECTOR HEADLIGHT ASSEMBLIES

01



FTL. CASCADIA LED PROJECTOR HEADLIGHT ASSEMBLIES

05



4" X 6" HEATED LENS LED PROJECTOR HEADLIGHTS

11



RADIANT SERIES LED WORK LAMPS

23



STROBE SERIES LED WORK LAMPS

27



**2" MINI LED WORK LAMP
POS DISPLAY**

31



**CLASS 1
LED WARNING LIGHTS**

47



**S,T&T TO BACK UP
DUAL REVOLUTION**

55



**3/4" ROUND
LED LIGHTING**

82

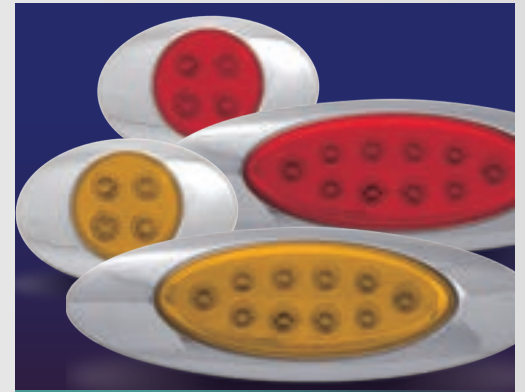

**GENERATION
MARKER LEDS**

89



**ALL-IN-ONE WHEEL ACCESSORY KITS
UNIVERSAL ACCESSORIES**

119



30" MUD FLAP HANGERS
UNIVERSAL ACCESSORIES

140



24" QUARTER FENDER KIT
FENDERS

155



60" SMOOTH FLANGED
HALF FENDER

159



STACK KITS
EXHAUST

181

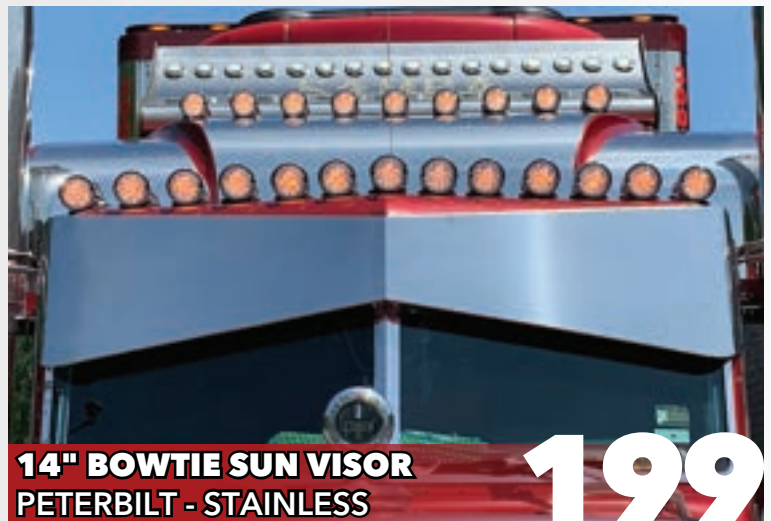

14" BOWTIE SUN VISOR
PETERBILT - STAINLESS

199



ANGLED GRILLE BARS
KENWORTH - STAINLESS

257



17" RAISED ROOF SUN VISOR
VOLVO - STAINLESS

277



HEATED JACKET

293



SLOTWALL DISPLAYS

324

	TABLE OF CONTENTS
01	HEADLIGHTS
23	WORK LAMPS
53	DUAL REVOLUTION
75	LED LIGHTING
113	LIGHTING ACCESSORIES
119	UNIVERSAL ACCESSORIES
155	FENDERS
181	EXHAUST
199	PETERBILT
235	KENWORTH
263	FREIGHTLINER
277	VOLVO
281	INTERNATIONAL
285	MACK
289	WESTERN STAR
293	MERCHANDISING
326	POLICIES

HEADLIGHT ASSEMBLIES

REDESIGNED

UNIVERSAL LED PROJECTOR HEADLIGHT ASSEMBLIES

[PATENTED DESIGN]

DESIGNED TO FIT

PETERBILT

379 1987-2007 378 1988-2007
365 2008-2009 357 1986-2008

KENWORTH

W900 1984+
T800 1987+
T600 1986-2007

FREIGHTLINER

CLASSIC 1988-2007

WESTERN STAR

6900 Series
4900 Series
4800 Series

**TOP
SELLER**



▲
CHROME
LED PROJECTOR
TLED-H120 Driver Side
TLED-H121 Passenger Side



▲
BLACK
LED PROJECTOR
TLED-H122 Driver Side
TLED-H123 Passenger Side

TECHNICAL SPECIFICATIONS

RAW LUMENS	Low: 2400 Lumens High: 1400 Lumens
EFFECTIVE LUMENS	Low: 520 Lumens High: 710 Lumens
OPERATING VOLTAGE	9-24 Volts (DRL Compatible)
LED POWER (W)	Low: 42 Watts High: 30 Watts
CURRENT DRAW	Low: 2.25 Amps @ 12 Volts High: 2.1 Amps @ 12 Volts

DAYTIME (A)	0.16 Amps
MARKER (A)	0.44 Amps
LENS MATERIAL	Polycarbonate Lens with Waterborne NLS Curable Coating for UV Protection
HOUSING MATERIAL	Polypropylene
WATERPROOF RATING	IP66 Rating
COMPLIANCE	DOT SAE FMVSS-108 CMVSS-108
WARRANTY	3 Years

FEATURES & BENEFITS

- DOT Compliant
- Meets FMVSS-108 & CMVSS-108 Standards
- Projector Technology for a Wider Beam
- Patented Design
- Halo Accents
- Integrated Traditional Visor
- Sold Individually
- 3 Year Warranty

FUNCTIONS



WIRING

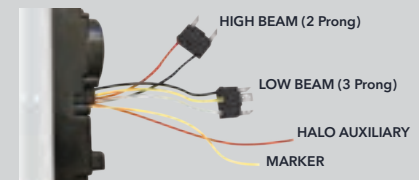

Wiring configurations for both Marker & Daytime Running Functions can be viewed online or in the provided Installation Guides that are found in the Retail Box.

INCLUDED ACCESSORIES



HOUSING BUCKET
Included for installation on Kenworth, Freightliner & Western Star Models.



TOP VIEW
Integrated traditional visor for added style. Replacement visor **TU-1043** is now available, see pg 114.

OEM REPLACEMENT



Replaces current OEM 4" x 6" Headlight Configuration

⚠ **WARNING: Cancer and Reproductive Harm - www.p65warnings.ca.gov**

SAFETY NEVER HAD
THIS MUCH STYLE



HEADLIGHT ASSEMBLIES

"RETRO SERIES" LED PROJECTOR HEADLIGHT ASSEMBLIES

DESIGNED TO FIT

PETERBILT

379 All Years **389** All Years **388** All Years
378 All Years **367** All Years **365** All Years
357 All Years **359** All Years



▲ CHROME
WITH HOUSING
TLED-H104 Driver Side
TLED-H105 Passenger Side

CUSTOM

DOUBLE ROUND 5.75"
 HEADLIGHT CONFIGURATIONS



▲ CHROME
WITH HOUSING & MOUNTING BRACKET
TLED-H106 Driver Side
TLED-H107 Passenger Side

TECHNICAL SPECIFICATIONS

RAW LUMENS	Low: 1800 Lumens High: 2700 Lumens	COLOR TEMPERATURE	6800 Kelvin
EFFECTIVE LUMENS	Low: 630 Lumens High: 900 Lumens	LENS MATERIAL	Polycarbonate
OPERATING VOLTAGE	9-24 Volts (DRL Compatible)	HOUSING MATERIAL	Polypropylene 304 Stainless (Bucket)
LED POWER (W)	Low: 6.5 Watts High: 12.8 Watts	WATERPROOF RATING	IP66 Rating
CURRENT DRAW	Low: 1.1 Amps @ 12.8 Volts High: 1.3 Amps @ 12.8 Volts	COMPLIANCE	DOT SAE FMVSS-108 CMVSS-108
		WARRANTY	3 Years

FEATURES & BENEFITS

- DOT Compliant
- Meets FMVSS-108 & CMVSS-108 Standards
- Projector Technology for a Wider Beam
- Halo Accents
- 304 Stainless Housing Bucket Included
- Sold Individually
- 3 Year Warranty

FUNCTIONS

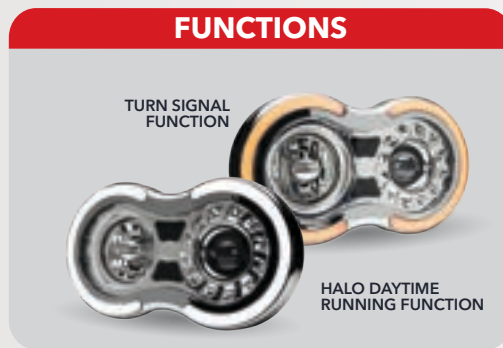

WIRING

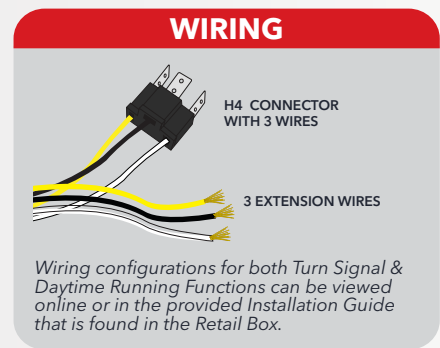

INCLUDED ACCESSORIES



304 STAINLESS HOUSING BUCKET
 Included in all "Retro Series" LED Projector Headlight Retail Boxes.



304 STAINLESS MOUNTING BRACKET
 Included for TLED-H106 & TLED-H107 Models ONLY.
 Mounting Brackets are also sold as a Pair (TU-1045).



REPLACEMENT



⚠ WARNING: Cancer and Reproductive Harm - www.p65warnings.ca.gov

OL'SKUL STYLING WITH **LATEST TECHNOLOGY**



HEADLIGHT ASSEMBLIES

FREIGHTLINER CASCADIA LED PROJECTOR HEADLIGHT ASSEMBLIES | FOG LIGHTS



DESIGNED TO FIT
2008-2018 CASCADIA MODELS
EXCLUDES 2017+ EVOLUTION MODELS

HEADLIGHT

CHROME
TLED-H66 Driver Side
TLED-H67 Passenger Side

BLACK
TLED-H68 Driver Side
TLED-H69 Passenger Side

TECHNICAL SPECIFICATIONS

RAW LUMENS	Low: 3290 Lumens High: 5972 Lumens
EFFECTIVE LUMENS	Low: 1000 Lumens High: 1500 Lumens
OPERATING VOLTAGE	12 Volts
LED POWER	Low: 17.76 Watts High: 11.4 Watts
CURRENT DRAW	Low: 1.48 Amps @ 12 Volts High: 0.95 Amps @ 12 Volts
DAYTIME (W)	3.9 Watts
TURN SIGNAL (W)	4.32 Watts
LENS MATERIAL	Polycarbonate
HOUSING MATERIAL	Polypropylene
WATERPROOF RATING	IP56 Rating
COMPLIANCE	DOT SAE FMVSS-108 CMVSS-108
WARRANTY	3 Years

FEATURES & BENEFITS

- ▶ DOT Compliant
- ▶ Meets FMVSS-108 & CMVSS-108 Standards
- ▶ Fog Lights are SAE J583 Compliant
- ▶ No Programming Needed
- ▶ Plug & Play Application
- ▶ Projector Technology for a Wider Beam
- ▶ Dual Function Daytime Running to Turn Signal Function (Headlight)
- ▶ Sold Individually
- ▶ 3 Year Warranty

NEW



DESIGNED TO FIT
2008-2016 CASCADIA MODELS

FOG LIGHT

CHROME
TLED-H39 Driver Side
TLED-H42 Passenger Side

BLACK
TLED-H43 Driver Side
TLED-H44 Passenger Side

TECHNICAL SPECIFICATIONS

RAW LUMENS (PAIR)	1400 Lumens
EFFECTIVE LUMENS (PAIR)	502 Lumens
OPERATING VOLTAGE	12 Volts
LED POWER	6.6 Watts
CURRENT DRAW	0.55 Amps @ 12.8 Volts
LENS MATERIAL	Polycarbonate
HOUSING MATERIAL	Polypropylene 30% Glass Fibre Polyamide
WATERPROOF RATING	IP67 Rating
COMPLIANCE	SAE J583
DIRECT REPLACEMENT	Driver OEM # A06-51909-000 Passenger OEM # A06-51909-001
WARRANTY	3 Years

Trux's Cascadia Headlight Assemblies and Fog Lights are the perfect team when looking to upgrade functionality, appearance and safety. Join the Cascadia Revolution - it's time to make a statement to the world that you're up to date with Safety, Technology and Style.

FUNCTIONS

DAYTIME RUNNING
FUNCTION



TURN SIGNAL
FUNCTION

Headlight Assembly Wiring configurations for both Turn Signal & Daytime Running Functions can be viewed online or in the provided Installation Guide that is found in the Retail Box.

WIRING

HEADLIGHT

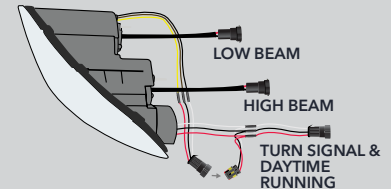

FOG LIGHT

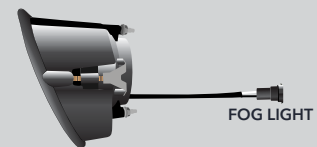

WARNING: Cancer and Reproductive Harm - www.p65warnings.ca.gov

THE **PERFECT** COMBO
SUPER BRIGHT PLUG & PLAY



HEADLIGHT ASSEMBLIES

FREIGHTLINER CENTURY PROJECTOR HEADLIGHT ASSEMBLIES (1996-2010)



▲
CHROME
LED PROJECTOR
TLED-H49 Driver Side
TLED-H50 Passenger Side

HALOGEN PROJECTOR
TLED-H13 Driver Side
TLED-H14 Passenger Side



▲
BLACK
LED PROJECTOR
TLED-H57 Driver Side
TLED-H58 Passenger Side

HALOGEN PROJECTOR
TLED-H15 Driver Side
TLED-H16 Passenger Side

LED PROJECTOR TECHNICAL SPECIFICATIONS

RAW LUMENS	Low: 3290 Lumens High: 5972 Lumens
EFFECTIVE LUMENS	Low: 1000 Lumens High: 1500 Lumens
OPERATING VOLTAGE	12 Volts
LED POWER	Low: 13.5 Watts High: 7.5 Watts
CURRENT DRAW	Low: 1.4 Amps @ 12 Volts High: 0.76 Amps @ 12 Volts
DAYTIME (W)	0.4 Watts
TURN SIGNAL (W)	0.4 Watts
SIDE MARKER (W)	0.1 Watts
LENS MATERIAL	Polycarbonate
HOUSING MATERIAL	Polypropylene
WATERPROOF RATING	IP56 Rating
COMPLIANCE	DOT SAE FMVSS-108 CMVSS-108
WARRANTY	2 Years on LEDs only

HALOGEN PROJECTOR TECHNICAL SPECIFICATIONS

RAW LUMENS	Low: 2200 Lumens High: 5900 Lumens
EFFECTIVE LUMENS	Low: 1100 Lumens High: 1300 Lumens
OPERATING VOLTAGE	12 Volts
HALOGEN POWER	Low: 55 Watts High: 60 Watts
CURRENT DRAW	Low: 4.2 Amps @ 12 Volts High: 4.3 Amps @ 12 Volts
DAYTIME (W)	0.4 Watts
TURN SIGNAL (W)	0.4 Watts
SIDE MARKER (W)	0.1 Watts
LENS MATERIAL	Polycarbonate
HOUSING MATERIAL	Polypropylene
WATERPROOF RATING	IP56 Rating
HALOGEN REPLACEMENT	Low: H7 High: HB3-9005
COMPLIANCE	DOT SAE FMVSS-108 CMVSS-108
WARRANTY	2 Years on LEDs only

FEATURES & BENEFITS

- DOT Compliant
- Meets FMVSS-108 & CMVSS-108 Standards
- Dual Function Daytime Running to Turn Signal Function
- Projector Technology for a Wider Beam
- Sold Individually
- 2 Year Warranty on LED Projector & LED Marker only

FUNCTIONS



WIRING

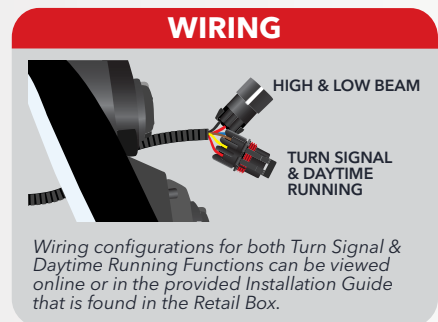

⚠ WARNING: Cancer and Reproductive Harm - www.p65warnings.ca.gov

YOUR **TRUCK** WILL BE
AHEAD BY A CENTURY



HEADLIGHT ASSEMBLIES

REDESIGNED

VOLVO VN/VNL PROJECTOR HEADLIGHT ASSEMBLIES (2003-2017)



▲
CHROME
LED PROJECTOR
TLED-H17 Driver Side
TLED-H18 Passenger Side

HALOGEN PROJECTOR
TLED-H45 Driver Side
TLED-H46 Passenger Side



▲
BLACK
LED PROJECTOR
TLED-H19 Driver Side
TLED-H20 Passenger Side

HALOGEN PROJECTOR
TLED-H54 Driver Side
TLED-H55 Passenger Side

LED PROJECTOR TECHNICAL SPECIFICATIONS

RAW LUMENS	Low: 2750 Lumens High: 6450 Lumens
EFFECTIVE LUMENS	Low: 1000 Lumens High: 1500 Lumens
OPERATING VOLTAGE	12 Volts
LED POWER	Low: 15 Watts High: 9 Watts
CURRENT DRAW	Low: 1.41 Amps @ 12 Volts High: 0.72 Amps @ 12 Volts
DAYTIME (W)	0.6 Watts
TURN SIGNAL (W)	1 Watt
LENS MATERIAL	Polycarbonate
HOUSING MATERIAL	Polypropylene
WATERPROOF RATING	IP56 Rating
COMPLIANCE	DOT SAE FMVSS-108 CMVSS-108
WARRANTY	2 Years on LEDs only

HALOGEN PROJECTOR TECHNICAL SPECIFICATIONS

RAW LUMENS	Low: 2270 Lumens High: 5700 Lumens
EFFECTIVE LUMENS	Low: 1100 Lumens High: 1150 Lumens
OPERATING VOLTAGE	12 Volts
HALOGEN POWER	Low: 55 Watts High: 55 Watts
CURRENT DRAW	Low: 4.08 Amps @ 12 Volts High: 4.71 Amps @ 12 Volts
DAYTIME (W)	0.6 Watts
TURN SIGNAL (W)	1 Watt
LENS MATERIAL	Polycarbonate
HOUSING MATERIAL	Polypropylene
WATERPROOF RATING	IP56 Rating
COMPLIANCE	DOT SAE FMVSS-108 CMVSS-108
WARRANTY	2 Years on LEDs only

FEATURES & BENEFITS

- DOT Compliant
- Meets FMVSS-108 & CMVSS-108 Standards
- No Programming Needed
- Plug & Play Application
- Projector Technology for a Wider Beam
- Halo Accents
- Dual Function Daytime Running to Turn Signal Function
- Sold Individually
- 2 Year Warranty on LED Projector & LED Marker only

FUNCTIONS



WIRING

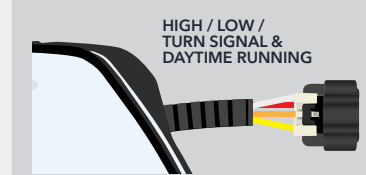

Wiring configurations for both Turn Signal & Daytime Running Functions can be viewed online or in the provided Installation Guide that is found in the Retail Box. Plug & Play.

⚠ WARNING: Cancer and Reproductive Harm - www.p65warnings.ca.gov

PLUG & PLAY

WITH NO DOWNTIME



HEADLIGHTS

4" X 6" HEATED LED PROJECTOR LOW BEAM | HIGH BEAM

NEW



CHROME
LED PROJECTOR
TLED-H12 Low Beam
TLED-H11 High Beam

TECHNICAL SPECIFICATIONS

LED POWER	27 Watts
RAW LUMENS	Low: 1300 Lumens High: 2400 Lumens
EFFECTIVE LUMENS	Low: 850 Lumens High 1150 Lumens
BEAM PATTERN	TLED-H12: Low Beam TLED-H11: High Beam
OPERATING VOLTAGE	9-24 Volts (DRL Compatible)
CURRENT DRAW	2.3 Amps @ 12 Volts
COLOR TEMPERATURE	6000 Kelvin
INTERIOR	Chrome
HOUSING MATERIAL	Aluminum Alloy
LENS MATERIAL	Polycarbonate
WATERPROOF RATING	IP67 Rating
COMPLIANCE	DOT SAE FMVSS-108 CMVSS-108
WARRANTY	7 Years

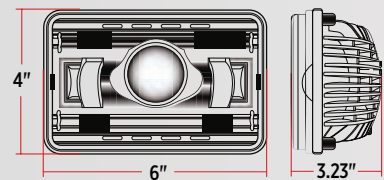

- RETROFIT**
- | | |
|----------|-----------|
| LOW BEAM | HIGH BEAM |
| ➤ 4652 | ➤ 4651 |
| ➤ H4652 | ➤ H4651 |
| ➤ H4656 | ➤ H5051 |
| ➤ H4662 | |
| ➤ H4739 | |
| ➤ H5062 | |

WIRING

HIGH BEAM H4 CONNECTOR
(2 Wires)

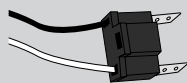

LOW BEAM H4 CONNECTOR
(3 Wires)



Plug & Play

BEAM PATTERN

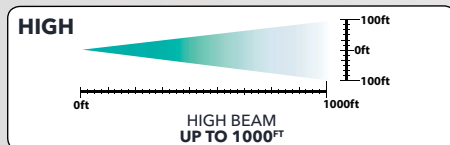
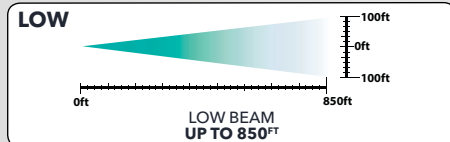

**DOT
COMPLIANT**

LOW BEAM
**1300
LUMENS**

HIGH BEAM
**2400
LUMENS**



BEAM PATTERN COMPARISON

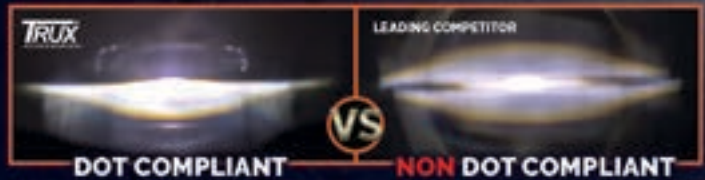

Trux's Heated LED Projector Headlight's Beam Pattern **MEETS** Stringent DOT Standards compared to the leading competitor's Beam Pattern which does not!

QUICK HEAT TECHNOLOGY
HEAT ELEMENT ACTIVATES WHEN TEMPERATURE REACHES 3°C (37.4°F)

LED PROJECTOR TECHNOLOGY

DOT COMPLIANT

7 YEAR WARRANTY

⚠ WARNING: Cancer and Reproductive Harm - www.p65warnings.ca.gov



**TRUX'S LED HEADLIGHTS WITH
HEATED LENS
4" x 6" HEADLIGHT POS DISPLAYS**

**TLED-H12
TRX-241
LOW BEAM**



**TLED-H11
TRX-240
HIGH BEAM**



SEE PAGE 317 FOR MORE INFORMATION

LED HEADLIGHTS

A light emitting diode (LED) uses electric current to emit light through a semi conductor (two-lead) device.

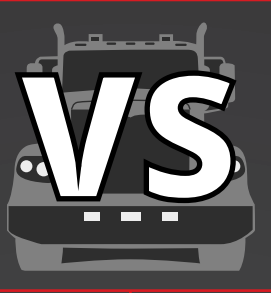

HALOGEN HEADLIGHTS

Halogen headlight bulbs use halogen gas to react chemically with the tungsten that evaporates from the burning filament.

VISIBILITY

IF OTHER TRUCKERS CAN SEE THE DIFFERENCE,
SO CAN YOU!

20% GREATER

PERCEPTION OF BRIGHTNESS

! Road tests have discovered that drivers, driving with LED lights perceived to see the road 20% brighter than driving with halogen lights.

LED HEADLIGHTS ARE THE
MOST LUMINOUS

! A comparison of photometric beam pattern intensity across 3 different test routes in Ann Arbor, MI.

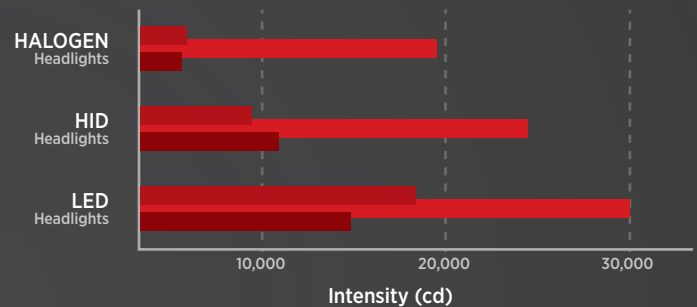

COST

! **DECREASE YOUR DOWNTIME**
Not having to change your headlight often decreases the downtime on the job.

UP TO 50,000 HOURS
LIFETIME AVERAGE OF LED BULBS

UP TO 1,000 HOURS
LIFETIME AVERAGE OF HALOGEN BULBS

CHANCES ARE
YOU WILL BE REPLACING YOUR TRUCK
BEFORE REPLACING YOUR LED BULBS

SAFETY

FEELING SAFER
WHILE DRIVING AT NIGHT

! **OBSTACLES AHEAD**
Several Road Studies indicate that LED Headlights improve the visibility of lane markings (white lines) and other hazards (pedestrians, road signs).

ENERGY

LESS ENERGY
MEANS MORE LIGHTS!

UP TO 12X
LESS ENERGY
USAGE THAN HALOGEN BULBS

! LED bulbs draw less energy from your truck than regular Halogen bulbs. Drawing less energy prolongs the life of your truck's starter, battery and alternator.

UPGRADE TO LED

- 👍 20% GREATER PERCEPTION OF BRIGHTNESS
- 👍 MOST LUMINOUS IN THE INDUSTRY
- 👍 SAFER DRIVING AT NIGHT FROM IMPROVED VISIBILITY
- 👍 UP TO 50,000 AVERAGE LIFETIME HOURS
- 👍 UP TO 12x LESS ENERGY THAN HALOGEN

Plainis, S., IJ Murray, and I G Pallikaris. "Road Traffic Casualties: Understanding the Night-time Death Toll." Injury Prevention 12.2 (2006): 125-128. PMC. Web. 2 Dec. 2016
Uchida, M., Kita, Y., Minoda (Kimura), T., Ueki, R. et al., "Visibility of Pavement Markings with LED Headlamps," SAE Technical Paper 2014-01-0438, 2014, doi:10.4271/2014-01-0438.
Plainis, S., and I. H. Murray. "Reaction times as an Index of Visual Conspicuity When Driving at Night." Reaction times as an Index of Visual Conspicuity When Driving at Night (2002): 409-15.
Michael, Hamm and Martin, Lampen, "Reality Check: How different is the perception of LED-light vs Halogen-light on the road?," ISAL 2011 - Proceedings, 2011

4" X 6" LED PROJECTOR

LOW BEAM | HIGH BEAM



▲
CHROME
LED PROJECTOR
TLED-H6 Low Beam
TLED-H7 High Beam

▲
BLACK
LED PROJECTOR
TLED-H73 Low Beam
TLED-H75 High Beam

TECHNICAL SPECIFICATIONS

LED POWER	27 Watts
RAW LUMENS	Low: 1300 Lumens High: 2400 Lumens
EFFECTIVE LUMENS	Low: 850 Lumens High 1150 Lumens
OPERATING VOLTAGE	9-24 Volts (DRL Compatible)
CURRENT DRAW	2.3 Amps @ 12 Volts

COLOR TEMPERATURE	6000 Kelvin
INTERIOR	Black or Chrome
HOUSING MATERIAL	Aluminum Alloy
LENS MATERIAL	Polycarbonate
WATERPROOF RATING	IP67 Rating
COMPLIANCE	DOT SAE FMVSS-108 CMVSS-108
WARRANTY	7 Years

- RETROFIT**
- | | | |
|-----------------|---------|------------------|
| LOW BEAM | | HIGH BEAM |
| ➤ 4652 | ➤ H4739 | ➤ 4651 |
| ➤ H4652 | ➤ H5062 | ➤ H4651 |
| ➤ H4656 | | ➤ H5051 |
| ➤ H4662 | | |

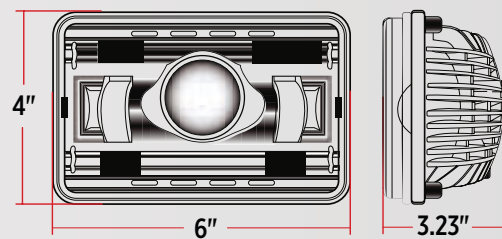
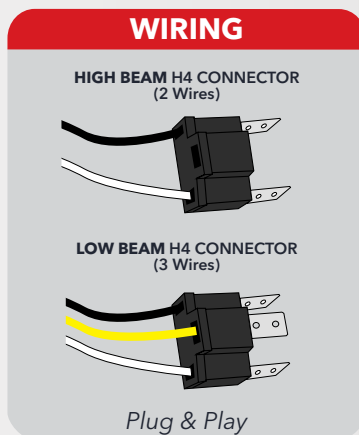

DOT COMPLIANT **LOW BEAM 1300 LUMENS** **HIGH BEAM 2400 LUMENS**

BEAM PATTERN

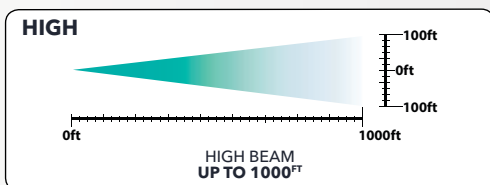
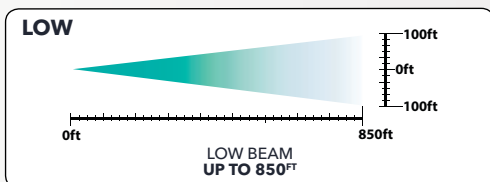

⚠ WARNING: Cancer and Reproductive Harm - www.p65warnings.ca.gov

HEADLIGHTS

4" X 6" LED REFLECTOR LOW BEAM | HIGH BEAM



CHROME
TLED-H2 Low Beam

TECHNICAL SPECIFICATIONS

LED POWER	9 Watts
RAW LUMENS	1100 Lumens
EFFECTIVE LUMENS	670 Lumens
BEAM PATTERN	Low Beam
DIODES	2 Diodes
OPERATING VOLTAGE	9-24 Volts (DRL Compatible)
CURRENT DRAW	0.9 Amps @ 12 Volts
COLOR TEMPERATURE	6800 Kelvin
HOUSING MATERIAL	Aluminum Die Cast
LENS MATERIAL	Polycarbonate
WATERPROOF RATING	IP67 Rating
COMPLIANCE	DOT SAE FMVSS-108 CMVSS-108
WARRANTY	5 Years

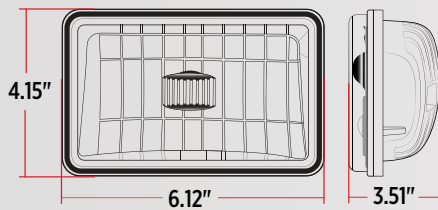

- RETROFIT**
- 4652 ➤ H4739
 - H4652 ➤ H5062
 - H4656
 - H4662

BEAM PATTERN

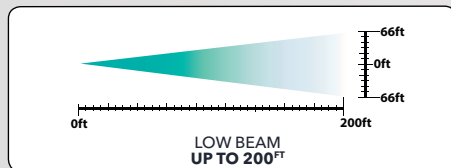

DOT
COMPLIANT

LOW BEAM
1100
LUMENS

WIRING

H4 CONNECTOR
(3 Wires)

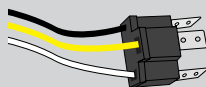

Plug & Play

CHROME
TLED-H1 High Beam

TECHNICAL SPECIFICATIONS

LED POWER	9 Watts
RAW LUMENS	1700 Lumens
EFFECTIVE LUMENS	670 Lumens
BEAM PATTERN	High Beam
DIODES	2 Diodes
OPERATING VOLTAGE	9-24 Volts (DRL Compatible)
CURRENT DRAW	1 Amp @ 12 Volts
COLOR TEMPERATURE	6800 Kelvin
HOUSING MATERIAL	Aluminum Die Cast
LENS MATERIAL	Polycarbonate
WATERPROOF RATING	IP67 Rating
COMPLIANCE	DOT SAE FMVSS-108 CMVSS-108
WARRANTY	5 Years

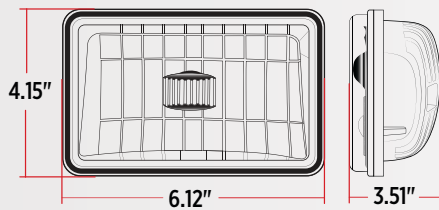

- RETROFIT**
- 4651
 - H4651
 - H5051

BEAM PATTERN

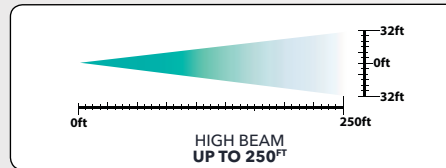

DOT
COMPLIANT

HIGH BEAM
1700
LUMENS

WIRING

H4 CONNECTOR
(2 Wires)

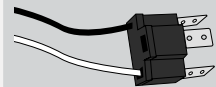

Plug & Play

⚠ WARNING: Cancer and Reproductive Harm - www.p65warnings.ca.gov



TRUX'S LED REFLECTOR 4" x 6" HEADLIGHTS

**HALOGEN
HEADLIGHT**



VS

**LED STANDARD
HEADLIGHT**



TRUX'S LED REFLECTOR HEADLIGHTS ARE PERFECT FOR OWNER OPERATORS OR FLEETS LOOKING FOR A HEADLIGHT SIGNIFICANTLY BRIGHTER THAN THE STANDARD HALOGENS. THE UPGRADE RELIES ON THE FACT THAT LED HEADLIGHTS ARE MORE RELIABLE, EFFICIENT AND ILLUMINATE A BRIGHT WHITE LIGHT IN COMPARISON TO HALOGEN MODELS THAT ILLUMINATE A DIM YELLOW LIGHT.



TLED-H1
HIGH BEAM
9-24v DRL COMPATIBLE
1700 LUMENS

TLED-H2
LOW BEAM
DRL COMPATIBLE 9-24v
1100 LUMENS

LED REFLECTOR TECHNOLOGY



1700 LUMENS (HIGH BEAM)



1100 LUMENS (LOW BEAM)



DOT COMPLIANT



HEADLIGHTS

4" X 6" OFF ROAD LED COMBINATION HIGH & LOW BEAM

OFF ROAD



CHROME
TLED-H71 High & Low Beam

TECHNICAL SPECIFICATIONS

LED POWER	Low: 15 Watts High: 45 Watts
RAW LUMENS	Low: 1500 Lumens High: 3000 Lumens
EFFECTIVE LUMENS	Low: 1000 Lumens High: 2000 Lumens
BEAM PATTERN	Combination High & Low
DIODES	15 Diodes
OPERATING VOLTAGE	12-24 Volts
CURRENT DRAW	2.44 Amps @ 12 Volts
COLOR TEMPERATURE	6500 Kelvin
HOUSING MATERIAL	Aluminum Die Cast
LENS MATERIAL	Polycarbonate
WATERPROOF RATING	IP67 Rating
COMPLIANCE	Off Road Use Only
WARRANTY	1 Year

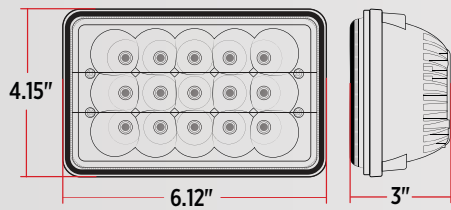

RETROFIT

- H6545
- H4666
- HP6545
- H4668

BEAM PATTERN

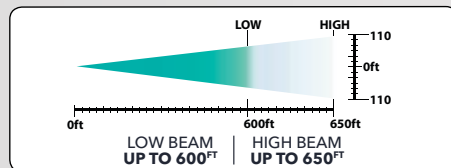

OFF ROAD USE ONLY

LOW BEAM 1500 LUMENS

HIGH BEAM 3000 LUMENS

WIRING

H4 CONNECTOR
(3 Wires)

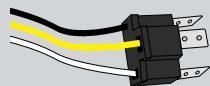

Plug & Play

OFF ROAD



BLACK
TLED-H5 High & Low Beam

TECHNICAL SPECIFICATIONS

LED POWER	Low: 15 Watts High: 45 Watts
RAW LUMENS	Low: 1500 Lumens High: 3000 Lumens
EFFECTIVE LUMENS	Low: 1000 Lumens High: 2000 Lumens
BEAM PATTERN	Combination High & Low
DIODES	15 Diodes
OPERATING VOLTAGE	12-24 Volts
CURRENT DRAW	2.44 Amps @ 12 Volts
COLOR TEMPERATURE	6500 Kelvin
HOUSING MATERIAL	Aluminum Die Cast
LENS MATERIAL	Polycarbonate
WATERPROOF RATING	IP67 Rating
COMPLIANCE	Off Road Use Only
WARRANTY	1 Year

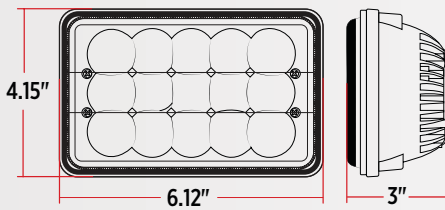

RETROFIT

- H6545
- H4666
- HP6545
- H4668

BEAM PATTERN

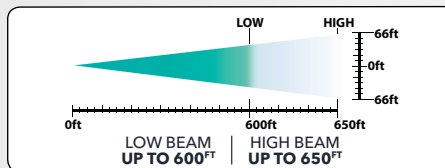

OFF ROAD USE ONLY

LOW BEAM 1500 LUMENS

HIGH BEAM 3000 LUMENS

WIRING

H4 CONNECTOR
(3 Wires)

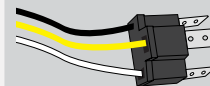

Plug & Play

WARNING: Cancer and Reproductive Harm - www.p65warnings.ca.gov

5.75" LED PROJECTOR WITH HALO ACCENTS

LOW BEAM | HIGH BEAM



CHROME
TLED-H63 Low Beam

TECHNICAL SPECIFICATIONS

LED POWER	22 Watts
RAW LUMENS	1500 Lumens
EFFECTIVE LUMENS	1200 Lumens
BEAM PATTERN	Low Beam
DIODES	1 Diode
OPERATING VOLTAGE	10-30 Volts
CURRENT DRAW	1.85 Amps @ 12 Volts
COLOR TEMPERATURE	6000 Kelvin
HOUSING MATERIAL	Aluminum Die Cast
LENS MATERIAL	Polycarbonate
WATERPROOF RATING	IP67 Rating
COMPLIANCE	DOT SAE FMVSS-108 CMVSS-108
WARRANTY	1 Year

CHROME
TLED-H56 High Beam

TECHNICAL SPECIFICATIONS

LED POWER	22 Watts
RAW LUMENS	1500 Lumens
EFFECTIVE LUMENS	1200 Lumens
BEAM PATTERN	High Beam
DIODES	1 Diode
OPERATING VOLTAGE	10-30 Volts
CURRENT DRAW	1.85 Amps @ 12 Volts
COLOR TEMPERATURE	6000 Kelvin
HOUSING MATERIAL	Aluminum Die Cast
LENS MATERIAL	Polycarbonate
WATERPROOF RATING	IP67 Rating
COMPLIANCE	DOT SAE FMVSS-108 CMVSS-108
WARRANTY	1 Year

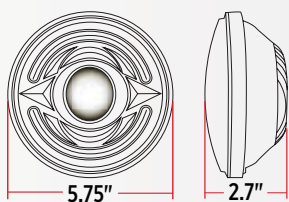

RETROFIT
↘ H5006

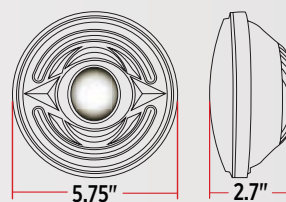

RETROFIT
↘ H5001

BEAM PATTERN

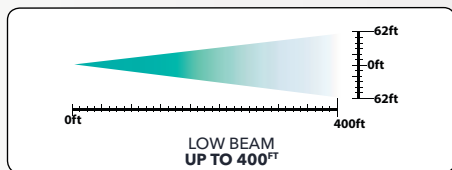

DOT
COMPLIANT

LOW BEAM
1500
LUMENS

WIRING

H4 CONNECTOR
(3 Wires with Extra Red Wire
For Halo Function)

Plug & Play

BEAM PATTERN

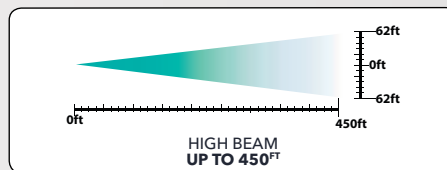

DOT
COMPLIANT

HIGH BEAM
1500
LUMENS

WIRING

H4 CONNECTOR
(3 Wires with Extra Red Wire
For Halo Function)

Plug & Play

HEADLIGHTS

5" X 7" LED PROJECTOR WITH HALO - COMBINATION HIGH & LOW BEAM



CHROME
TLED-H4 High & Low Beam

TECHNICAL SPECIFICATIONS

LED POWER	Low: 9 Watts High: 15 Watts
RAW LUMENS	Low: 1890 Lumens High: 2600 Lumens
EFFECTIVE LUMENS	Low: 700 Lumens High: 800 Lumens
BEAM PATTERN	Combination High & Low
DIODES	7 Diodes
OPERATING VOLTAGE	9-24 Volts (DRL Compatible)
CURRENT DRAW	Low: 0.7 Amps @ 12.8 Volts High: 1.2 Amps @ 12.8 Volts
COLOR TEMPERATURE	6800 Kelvin
HOUSING MATERIAL	Aluminum Die Cast
LENS MATERIAL	Polycarbonate
WATERPROOF RATING	IP67 Rating
COMPLIANCE	DOT SAE FMVSS-108 CMVSS-108
WARRANTY	7 Years

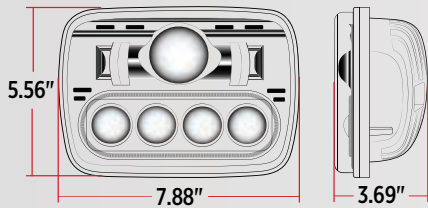

RETROFIT

- 6052
- 6053
- H6054
- HD6054
- HP6054

BEAM PATTERN

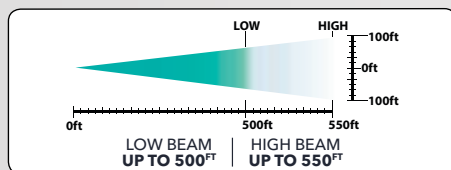

DOT COMPLIANT

LOW BEAM 1890 LUMENS

HIGH BEAM 2600 LUMENS

WIRING

H4 CONNECTOR
(3 Wires with Extra Red Wire
For Halo Function)

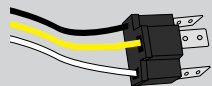

Plug & Play

5" X 7" LED REFLECTOR COMBINATION HIGH & LOW BEAM



CHROME
TLED-H74 High & Low Beam

TECHNICAL SPECIFICATIONS

LED POWER	Low: 6.5 Watts High: 13 Watts
RAW LUMENS	Low: 900 Lumens High: 2000 Lumens
EFFECTIVE LUMENS	Low: 620 Lumens High: 900 Lumens
BEAM PATTERN	Combination High & Low
DIODES	3 Diodes
OPERATING VOLTAGE	9-24 Volts (DRL Compatible)
CURRENT DRAW	Low: 0.5 Amps @ 12.8 Volts High: 1.1 Amps @ 12.8 Volts
COLOR TEMPERATURE	6800 Kelvin
HOUSING MATERIAL	Aluminum Die Cast
LENS MATERIAL	Polycarbonate
WATERPROOF RATING	IP67 Rating
COMPLIANCE	DOT SAE FMVSS-108 CMVSS-108
WARRANTY	5 Years

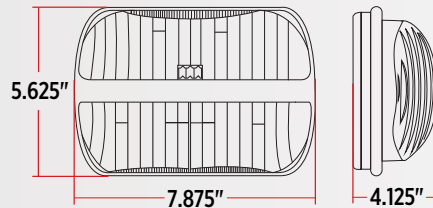

RETROFIT

- 6052
- 6053
- H6054
- HD6054
- HP6054

BEAM PATTERN

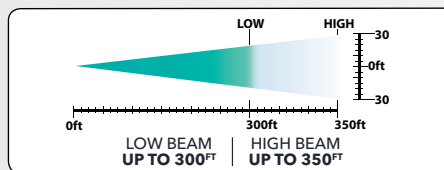

DOT COMPLIANT

LOW BEAM 900 LUMENS

HIGH BEAM 2000 LUMENS

WIRING

H4 CONNECTOR
(3 Wires)

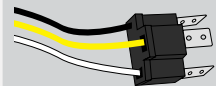

Plug & Play

WARNING: Cancer and Reproductive Harm - www.p65warnings.ca.gov

5" X 7" OFF ROAD LED COMBINATION HIGH & LOW BEAM

OFF ROAD



CHROME
TLED-H52 High & Low Beam

TECHNICAL SPECIFICATIONS

LED POWER	Low: 21 Watts High: 39 Watts
RAW LUMENS	Low: 2100 Lumens High: 3900 Lumens
EFFECTIVE LUMENS	Low: 1000 Lumens High: 1900 Lumens
BEAM PATTERN	Combination High & Low
DIODES	13 Diodes
OPERATING VOLTAGE	9-32 Volts
CURRENT DRAW	Low: 1.23 Amps @ 12 Volts High: 2.28 Amps @ 12 Volts
COLOR TEMPERATURE	6000 Kelvin
HOUSING MATERIAL	Aluminum Die Cast
LENS MATERIAL	Polycarbonate
WATERPROOF RATING	IP67 Rating
COMPLIANCE	Off Road Use Only
WARRANTY	1 Year

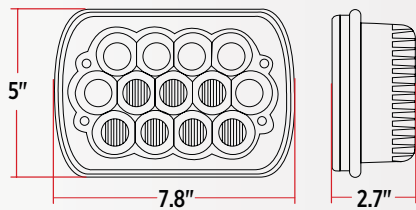

RETROFIT

- 6052
- 6053
- H6054
- HD6054
- HP6054

BEAM PATTERN

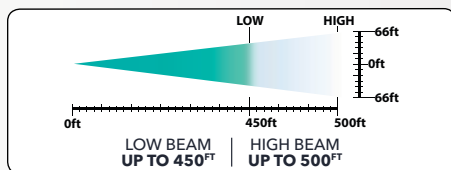

OFF ROAD USE ONLY	LOW BEAM 2100 LUMENS	HIGH BEAM 3900 LUMENS
-----------------------------	------------------------------------------	-------------------------------------------

WIRING

H4 CONNECTOR
(3 Wires)

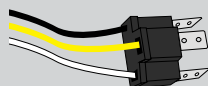

Plug & Play



WARNING: Cancer and Reproductive Harm - www.p65warnings.ca.gov

HEADLIGHTS

7" LED PROJECTOR WITH HALO - COMBINATION HIGH & LOW BEAM



▲ **CHROME**
TLED-H3 High & Low Beam

▲ **BLACK**
TLED-H70 High & Low Beam

TECHNICAL SPECIFICATIONS

LED POWER	Low: 9 Watts High: 20 Watts
RAW LUMENS	Low: 1890 Lumens High: 3000 Lumens
EFFECTIVE LUMENS	Low: 700 Lumens High: 800 Lumens
BEAM PATTERN	Combination High & Low
DIODES	9 Diodes
OPERATING VOLTAGE	9-24 Volts (DRL Compatible)
CURRENT DRAW	Low: 0.7 Amps @ 12.8 Volts High: 1.55 Amps @ 12.8 Volts
COLOR TEMPERATURE	6800 Kelvin
HOUSING MATERIAL	Aluminum Die Cast
LENS MATERIAL	Polycarbonate
WATERPROOF RATING	IP67 Rating
COMPLIANCE	DOT SAE FMVSS-108 CMVSS-108
WARRANTY	7 Years

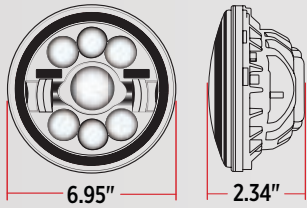

RETROFIT

- 6014
- 6015
- 6016
- H6024
- PAR56

BEAM PATTERN

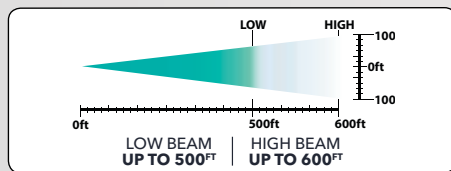

DOT COMPLIANT

LOW BEAM
1890 LUMENS

HIGH BEAM
3000 LUMENS

WIRING

H4 CONNECTOR
(3 Wires with Extra Red Wire
For Halo Function)

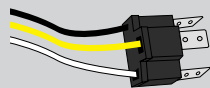

Plug & Play

BEAM PATTERN

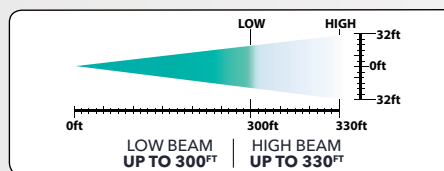

DOT COMPLIANT

LOW BEAM
2700 LUMENS

HIGH BEAM
2700 LUMENS

RETROFIT

- 6014
- 6015
- 6016
- H6024
- PAR56

WIRING

H4 CONNECTOR
(3 Wires)

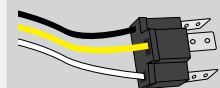

Plug & Play

⚠ WARNING: Cancer and Reproductive Harm - www.p65warnings.ca.gov

7" OFF ROAD LED

WITH HALO - COMBINATION HIGH & LOW BEAM

OFF ROAD



CHROME
TLED-H51 High & Low Beam

TECHNICAL SPECIFICATIONS

LED POWER	Low: 30 Watts High: 60 Watts
RAW LUMENS	Low: 3000 Lumens High: 6000 Lumens
EFFECTIVE LUMENS	Low: 1470 Lumens High: 3000 Lumens
BEAM PATTERN	Combination High & Low
DIODES	12 Diodes
OPERATING VOLTAGE	9-32 Volts
CURRENT DRAW	Low: 1.75 Amps @ 12 Volts High: 3.5 Amps @ 12 Volts
COLOR TEMPERATURE	6000 Kelvin
HOUSING MATERIAL	Aluminum Die Cast
LENS MATERIAL	Polycarbonate
WATERPROOF RATING	IP67 Rating
COMPLIANCE	Off Road Use Only
WARRANTY	1 Year

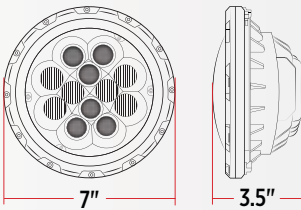

RETROFIT

- 6014
- 6015
- 6016
- H6024
- PAR56

BEAM PATTERN

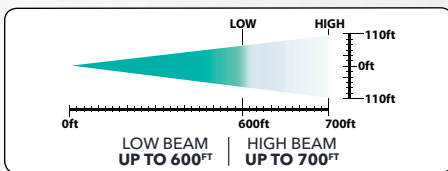

OFF ROAD
USE ONLY

LOW BEAM
3000
LUMENS

HIGH BEAM
6000
LUMENS

WIRING

H4 CONNECTOR
(3 Wires with Extra Red Wire
For Halo Function)

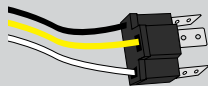

Plug & Play

WARNING: Cancer and Reproductive Harm - www.p65warnings.ca.gov



RADIANT

WORK LAMP SERIES

FIRST EVER WORK LAMPS WITH SIDE LIGHT OUTPUT

**360°
SIDE
LIGHT OUTPUT**

Introducing the best-selling Radiant Series of LED Work Lamps from Trux. This groundbreaking lineup features 360° of additional diodes around the circumference of the Work Lamp to offer both incredibly bright forward facing **SPOT** Beam AND side facing **FLOOD** Beam.



TLED-U103

4.5" LED WORK LAMP
WITH 360° SIDE LIGHT OUTPUT

TLED-U120

4.25" LED WORK LAMP
WITH 360° SIDE LIGHT OUTPUT

**PATENTED
DESIGN**

HEADLIGHT COMPARISON
NOT JUST YOUR LIGHT OUTPUT



TLED-U120
Radiant LED Work Lamp

OEM HALOGEN
Work Lamp

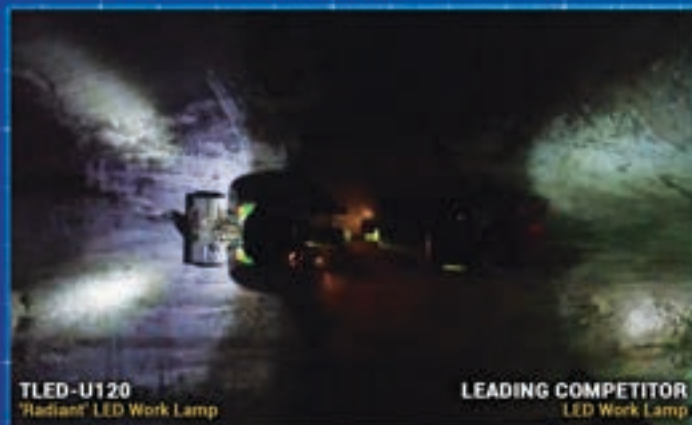

TLED-U120
Radiant LED Work Lamp

LEADING COMPETITOR
LED Work Lamp

These first ever COMBINATION LED Work Lamps produce up to 4000 lumens that provide up to 50% more illumination than a standard work light alone. This cutting-edge combination allows operators to enjoy the benefits of multiple applications all in one light.

WHAT IS RADIANT?

The 'Radiant Series' Work Lamps are designed with diodes placed on the circumference of the Work Lamp with specially designed reflector cups that projects the light out the sides of the work lamp.

SIDE LIGHT OUTPUT
FRONT VIEW



360° DIODES
SIDE VIEW

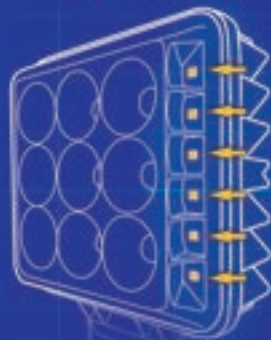

PERFECT FOR A WIDE RANGE OF APPLICATIONS



AGRICULTURAL



WRECKERS



SERVICE VEHICLES



DELIVERY VEHICLES

4.25" SQUARE COMBINATION SPOT & FLOOD BEAM

TOP
SELLER



COMBINATION SPOT & FLOOD BEAM
TLED-U120

[PATENT PENDING]

TECHNICAL SPECIFICATIONS

RAW LUMENS	4000 Lumens
EFFECTIVE LUMENS	2360 Lumens
BEAM PATTERN	Combination Spot & Flood
DIODES	9 Front 24 Side Diodes
OPERATING VOLTAGE	10-30 Volts
LED POWER	40 Watts
CURRENT DRAW	2.25 Amps @ 12 Volts
COLOR TEMPERATURE	6500 Kelvin
HOUSING MATERIAL	Aluminum Die Cast
BRACKET MATERIAL	Stainless Steel
LENS MATERIAL	Polycarbonate
WATERPROOF RATING	IP67 Rating
SOLD	Individually
WARRANTY	3 Years

BEAM PATTERN

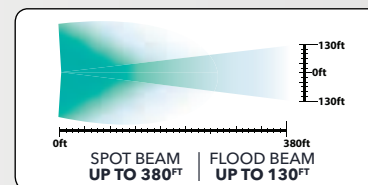

FUNCTION

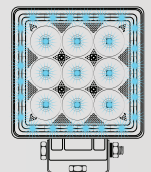

9 Front Diodes
24 Side Diodes

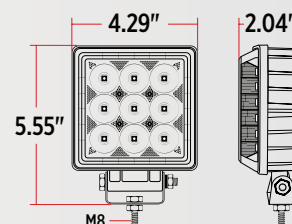

WIRING

2 WIRE CONNECTION

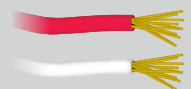

Connect the negative and positive work lamp wires to the corresponding negative and positive wires from the truck's wiring harness.

4000
LUMENS

**SPOT &
FLOOD**
BEAM

⚠ WARNING: Cancer and Reproductive Harm - www.p65warnings.ca.gov

DOUBLE FACE LED WORK LAMP



WITH 270° SIDE LIGHT OUTPUT

Now brighter than ever are Trux Radiant Double Face Work Lamps, a game changer to the industry. Designed with side radial LEDs and two spot functions on both faces of the light to create an intense brilliant forward and back lighting. This compact work light brings twice the amount of brightness to your work area without taking much space on your vehicle.



TLED-U116



FRONT



SIDE

The 'Double Face' LED Work Lamps are designed with diodes placed on the front and back as well as the circumference of the Work Lamp with specially designed reflector cups that projects the light out the sides of the work lamp.

RADIANT SERIES

DOUBLE FACE COMBINATION SPOT & FLOOD BEAM

NEW



COMBINATION SPOT & FLOOD BEAM
TLED-U116

[PATENT PENDING]

TECHNICAL SPECIFICATIONS

RAW LUMENS	2200 Lumens
EFFECTIVE LUMENS	1700 Lumens
BEAM PATTERN	Combination Spot & Flood
DIODES	6 Front 14 Side Diodes (Per Face)
OPERATING VOLTAGE	12-24 Volts
LED POWER	20 Watts
CURRENT DRAW	2.27 Amps @ 12 Volts
COLOR TEMPERATURE	6500 Kelvin
HOUSING MATERIAL	ADC12
BRACKET MATERIAL	Stainless Steel
LENS MATERIAL	Polycarbonate
WATERPROOF RATING	IP67 Rating
SOLD	Individually
WARRANTY	3 Years

BEAM PATTERN

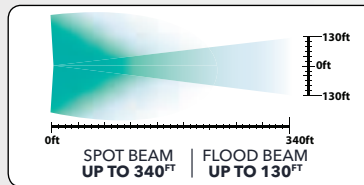

FUNCTION

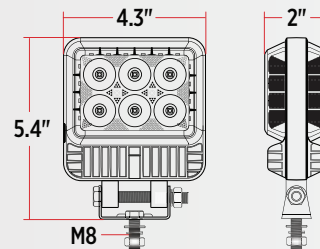
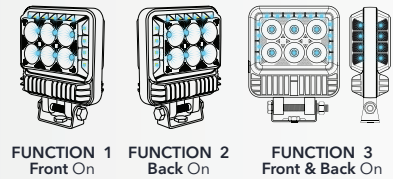

WIRING

3 WIRE CONNECTION & 2 POWER SWITCHES

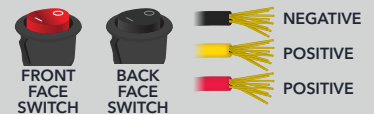

Refer to the Installation Instructions in the packaging for the wiring diagram.

2200
LUMENS
EACH SIDE

SPOT & FLOOD
BEAM

DOUBLE
FACE
LIGHTING

WARNING: Cancer and Reproductive Harm - www.p65warnings.ca.gov

4.5" ROUND COMBINATION SPOT & FLOOD BEAM

**TOP
SELLER**



4.5" ROUND (PAIR) COMBINATION SPOT & FLOOD BEAM

**TOP
SELLER**



COMBINATION SPOT & FLOOD BEAM

TLED-U103

TECHNICAL SPECIFICATIONS

RAW LUMENS	3000 Lumens
EFFECTIVE LUMENS	1800 Lumens
BEAM PATTERN	Combination Spot & Flood
DIODES	6 Front 8 Side Diodes
OPERATING VOLTAGE	12-24 Volts
LED POWER	30 Watts
CURRENT DRAW	2.5 Amps @ 12 Volts
COLOR TEMPERATURE	6500 Kelvin
HOUSING MATERIAL	ADC12
BRACKET MATERIAL	Stainless Steel
LENS MATERIAL	Polycarbonate
WATERPROOF RATING	IP67 Rating
SOLD	Individually
WARRANTY	3 Years

COMBINATION SPOT & FLOOD BEAM

TLED-U102

TECHNICAL SPECIFICATIONS

RAW LUMENS	4300 Lumens (Each)
EFFECTIVE LUMENS	1920 Lumens (Each)
BEAM PATTERN	Combination Spot & Flood
DIODES	6 Front 3 Side Diodes (Each)
OPERATING VOLTAGE	12-24 Volts
LED POWER	32 Watts (Each)
CURRENT DRAW	2.67 Amps @ 12 Volts
COLOR TEMPERATURE	6500 Kelvin
HOUSING MATERIAL	ADC12
BRACKET MATERIAL	Stainless Steel
LENS MATERIAL	Polycarbonate
WATERPROOF RATING	IP67 Rating
SOLD	As a Pair
WARRANTY	3 Years

BEAM PATTERN

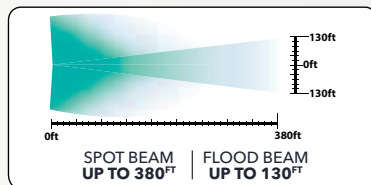

FUNCTION

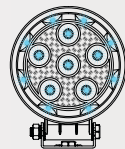

6 Front Diodes
8 Side Diodes

BEAM PATTERN

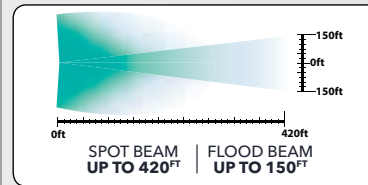

FUNCTION

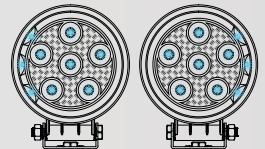

6 Front Diodes (Each)
3 Side Diodes (Each)

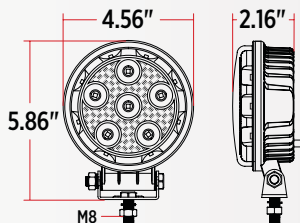

WIRING

2 WIRE CONNECTION



Connect the negative and positive work lamp wires to the corresponding negative and positive wires from the truck's wiring harness.

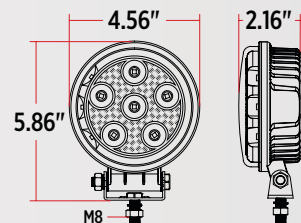

WIRING

2 WIRE CONNECTION

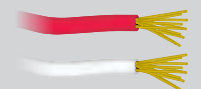

Connect the negative and positive work lamp wires to the corresponding negative and positive wires from the truck's wiring harness.

**3000
LUMENS**

**SPOT &
FLOOD
BEAM**

**4300
LUMENS EACH**

**SPOT &
FLOOD
BEAM**

**SOLD IN
PAIRS**

SPOT LED WORK LAMP WITH STROBE



360°
STROBE OUTPUT

Perfect for warning are Trux latest multi-functional LED Work Lamps. These LED Work Lamps have you covered from strobe warning to spot function, where you will be able to do your work and not realize the time of day. In line of sight, these cautionary LEDs allows you to see and be seen at a flick of a switch.

**PERFECT FOR
A WIDE RANGE OF APPLICATIONS**



AGRICULTURAL



WRECKERS



SERVICE VEHICLES



DELIVERY VEHICLES

STROBE SERIES

4.25" SQUARE
SPOT BEAM WITH AMBER STROBE

NEW



SPOT BEAM WITH AMBER STROBE
TLED-U118

TECHNICAL SPECIFICATIONS

RAW LUMENS	3500 Lumens
EFFECTIVE LUMENS	2500 Lumens
BEAM PATTERN	Spot Beam
DIODES	9 Front 24 Side Diodes
OPERATING VOLTAGE	12-24 Volts
LED POWER	40 Watts
CURRENT DRAW	2.5 Amps @ 12 Volts
COLOR TEMPERATURE	6500 Kelvin
HOUSING MATERIAL	Aluminum Die Cast
BRACKET MATERIAL	Stainless Steel
LENS MATERIAL	Polycarbonate
WATERPROOF RATING	IP67 Rating
SOLD	Individually
WARRANTY	3 Years

BEAM PATTERN

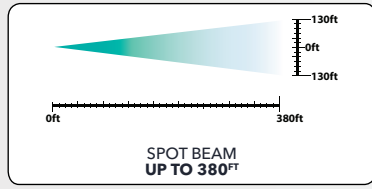

FUNCTIONS

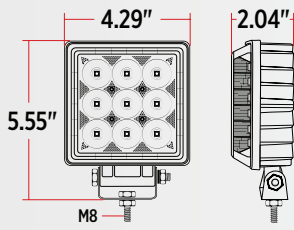
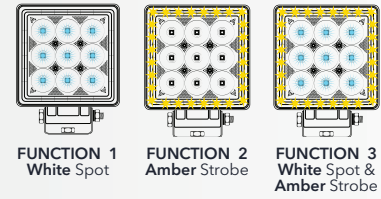

WIRING

3 WIRE CONNECTION & 2 POWER SWITCHES

STROBE SWITCH POWER SWITCH NEGATIVE POSITIVE/STROBE POSITIVE

Refer to the Installation Instructions in the packaging for the wiring diagram.

2500
LUMENS

SPOT
BEAM

STROBE
FUNCTION

2X
FUNCTIONS
IN ONE LIGHT

WARNING: Cancer and Reproductive Harm - www.p65warnings.ca.gov

4.5" ROUND SPOT BEAM WITH AMBER STROBE

NEW



SPOT BEAM WITH AMBER STROBE
TLED-U114

TECHNICAL SPECIFICATIONS

RAW LUMENS	1800 Lumens
EFFECTIVE LUMENS	1300 Lumens
BEAM PATTERN	Spot Beam
DIODES	5 White Diodes 20 Amber Diodes
OPERATING VOLTAGE	9-30 Volts
LED POWER	25 Watts
CURRENT DRAW	2 Amps @ 12V
COLOR TEMPERATURE	White: 6000 Kelvin Amber: 590 nm
HOUSING MATERIAL	Aluminum Die Cast
BRACKET MATERIAL	Stainless Steel
LENS MATERIAL	Polycarbonate
WATERPROOF RATING	IP67 Rating
SOLD	Individually
WARRANTY	3 Years

BEAM PATTERN

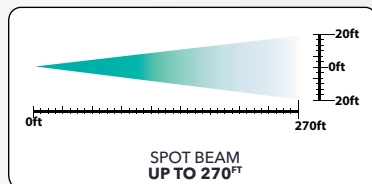

FUNCTIONS

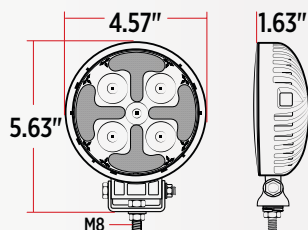
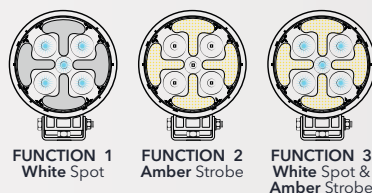

WIRING

3 WIRE CONNECTION & 2 POWER SWITCHES

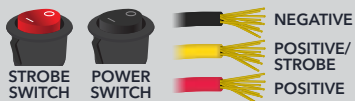

Refer to the Installation Instructions in the packaging for the wiring diagram.

1800
LUMENS

SPOT
BEAM

STROBE
FUNCTION

2X
FUNCTIONS
IN ONE LIGHT

7" HALF MOON FLOOD BEAM WITH AMBER STROBE



FUNCTION 1
White Flood Beam

FUNCTION 2
Amber Strobe

FLOOD BEAM WITH AMBER STROBE
TLED-U112 Surface Mount

TECHNICAL SPECIFICATIONS

RAW LUMENS	White: 800 Lumens Strobe: 750 Lumens
EFFECTIVE LUMENS	White: 780 Lumens Strobe: 700 Lumens
BEAM PATTERN	Flood Beam
DIODES	6 White Diodes 6 Amber Diodes
OPERATING VOLTAGE	12-24 Volts
LED POWER	8 Watts
CURRENT DRAW	0.69 Amps @ 12 Volts
COLOR TEMPERATURE	White: 6500 Kelvin Amber: 1800 Kelvin
HOUSING MATERIAL	Aluminum Die Cast
LENS MATERIAL	Polycarbonate
WATERPROOF RATING	IP65 Rating
SOLD	Individually
WARRANTY	3 Years

BEAM PATTERN

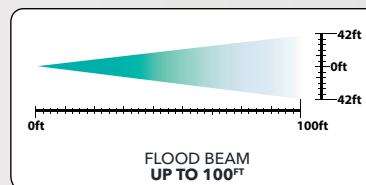

FUNCTIONS

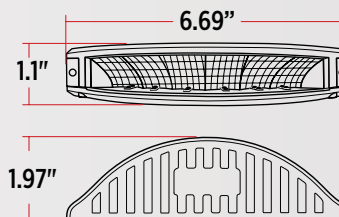

WIRING

3 WIRE CONNECTION & POWER SWITCH



Refer to the Installation Instructions in the packaging for the wiring diagram.

800
LUMENS

FLOOD
BEAM

STROBE
FUNCTION

2X
FUNCTIONS
IN ONE LIGHT

⚠ WARNING: Cancer and Reproductive Harm - www.p65warnings.ca.gov

STROBE SERIES

6" RECTANGLE SPOT BEAM WITH STROBE

**TOP
SELLER**



SPOT BEAM WITH AMBER STROBE

TLED-W4

TECHNICAL SPECIFICATIONS

RAW LUMENS	1400 Lumens
EFFECTIVE LUMENS	900 Lumens
BEAM PATTERN	Spot Beam
DIODES	20 Diodes
OPERATING VOLTAGE	10-30 Volts
LED POWER	18 Watts
CURRENT DRAW	1.05 Amps @ 12 Volts
COLOR TEMPERATURE	6000 Kelvin
HOUSING MATERIAL	Aluminum Die Cast
BRACKET MATERIAL	Stainless Steel
LENS MATERIAL	Polycarbonate
WATERPROOF RATING	IP67 Rating
SOLD	Sold Individually
WARRANTY	3 Years

BEAM PATTERN

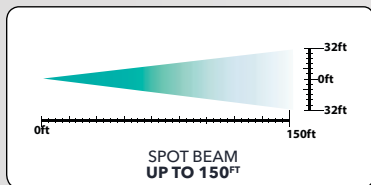

FUNCTIONS

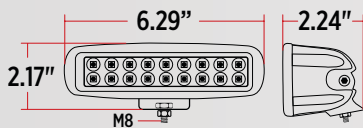
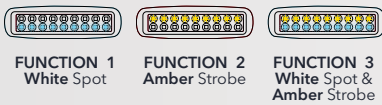

WIRING

3 WIRE CONNECTION & 2 POWER SWITCHES

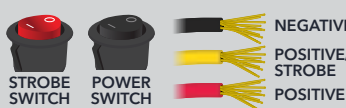

Refer to the Installation Instructions in the packaging for the wiring diagram.

1400
LUMENS

SPOT
BEAM

STROBE
FUNCTION

2X
FUNCTIONS
IN ONE LIGHT

SPOT BEAM WITH RED STROBE

TLED-W3

TECHNICAL SPECIFICATIONS

RAW LUMENS	1400 Lumens
EFFECTIVE LUMENS	900 Lumens
BEAM PATTERN	Spot Beam
DIODES	20 Diodes
OPERATING VOLTAGE	10-30 Volts
LED POWER	18 Watts
CURRENT DRAW	1.05 Amps @ 12 Volts
COLOR TEMPERATURE	6000 Kelvin
HOUSING MATERIAL	Aluminum Die Cast
BRACKET MATERIAL	Stainless Steel
LENS MATERIAL	Polycarbonate
WATERPROOF RATING	IP67 Rating
SOLD	Sold Individually
WARRANTY	3 Years

BEAM PATTERN

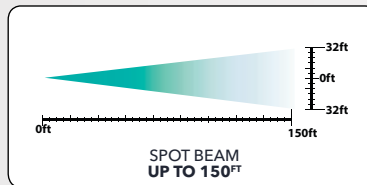

FUNCTIONS

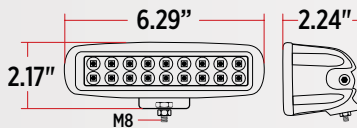

WIRING

3 WIRE CONNECTION & 2 POWER SWITCHES

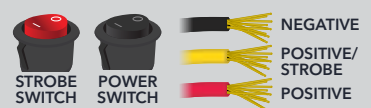

Refer to the Installation Instructions in the packaging for the wiring diagram.

1400
LUMENS

SPOT
BEAM

STROBE
FUNCTION

2X
FUNCTIONS
IN ONE LIGHT

WARNING: Cancer and Reproductive Harm - www.p65warnings.ca.gov

4" CUBE

SPOT BEAM WITH SIDE STROBE

**TOP
SELLER**



SPOT BEAM WITH AMBER STROBE
TLED-U106

TECHNICAL SPECIFICATIONS

RAW LUMENS	1800 Lumens (Each)
EFFECTIVE LUMENS	1500 Lumens (Each)
BEAM PATTERN	Spot Beam
DIODES	12 Front Diodes 7 Side Diodes
OPERATING VOLTAGE	9-30 Volts
LED POWER	18 Watts
CURRENT DRAW	1.2 Amps @ 12 Volts (Each)
COLOR TEMPERATURE	6000 Kelvin
HOUSING MATERIAL	Aluminum Die Cast
BRACKET MATERIAL	Stainless Steel
LENS MATERIAL	Polycarbonate
WATERPROOF RATING	IP67 Rating
SOLD	As a Pair
WARRANTY	3 Years

SPOT BEAM WITH RED STROBE
TLED-U107

TECHNICAL SPECIFICATIONS

RAW LUMENS	1800 Lumens (Each)
EFFECTIVE LUMENS	1500 Lumens (Each)
BEAM PATTERN	Spot Beam
DIODES	12 Front Diodes 7 Side Diodes
OPERATING VOLTAGE	9-30 Volts
LED POWER	18 Watts
CURRENT DRAW	1.2 Amps @ 12 Volts (Each)
COLOR TEMPERATURE	6000 Kelvin
HOUSING MATERIAL	Aluminum Die Cast
BRACKET MATERIAL	Stainless Steel
LENS MATERIAL	Polycarbonate
WATERPROOF RATING	IP67 Rating
SOLD	As a Pair
WARRANTY	3 Years

BEAM PATTERN

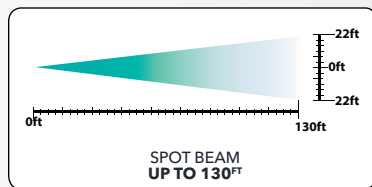

FUNCTIONS

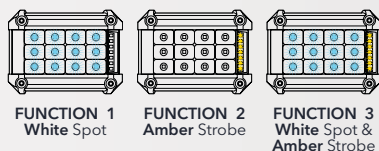

BEAM PATTERN

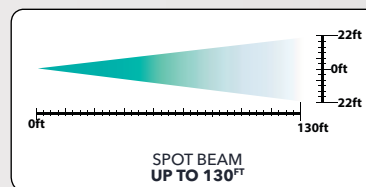

FUNCTIONS

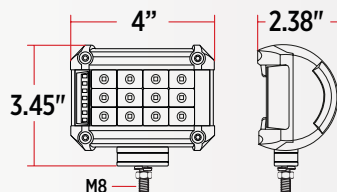
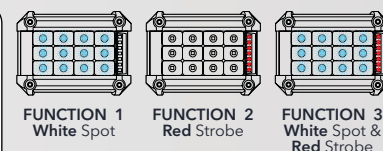

WIRING

3 WIRE CONNECTION & 2 POWER SWITCHES



Refer to the Installation Instructions in the packaging for the wiring diagram.

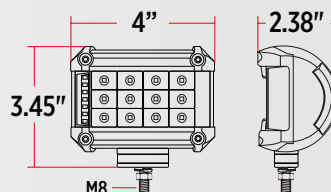

WIRING

3 WIRE CONNECTION & 2 POWER SWITCHES



Refer to the Installation Instructions in the packaging for the wiring diagram.

1800
LUMENS EACH

SPOT
BEAM

58 FPM
STROBE

SOLD IN
PAIRS

1800
LUMENS EACH

SPOT
BEAM

58 FPM
STROBE

SOLD IN
PAIRS

MINI LED WORK LAMPS

2" MINI POS DISPLAY SPOT BEAM - BOX OF 30

**TOP
SELLER**



TRX-135
BOX CONTAINS
30 x TLED-U104



SPOT BEAM
TRX-135 Box of 30

TECHNICAL SPECIFICATIONS

RAW LUMENS	1500 Lumens
EFFECTIVE LUMENS	900 Lumens
BEAM PATTERN	Spot Beam
DIODES	9 Diodes
OPERATING VOLTAGE	12-24 Volts
LED POWER	18 Watts
CURRENT DRAW	0.87 Amp @ 12 Volts
COLOR TEMPERATURE	6500 Kelvin
HOUSING MATERIAL	Aluminum Die Cast
BRACKET MATERIAL	Stainless Steel
LENS MATERIAL	Polycarbonate
WATERPROOF RATING	IP67 Rating
SOLD	Box of 30
WARRANTY	3 Years

BEAM PATTERN

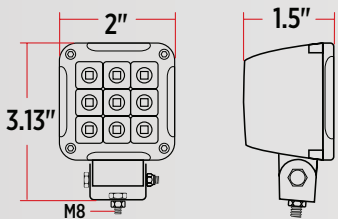
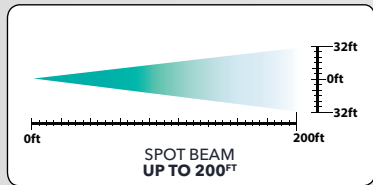

WIRING

2 WIRE CONNECTION



Connect the negative and positive work lamp wires to the corresponding negative and positive wires from the truck's wiring harness.

1500
LUMENS

SPOT
BEAM

SOLD IN BOX OF
30 PCS

6" RECTANGLE POS DISPLAY FLOOD BEAM - BOX OF 21

NEW



TRX-239
BOX CONTAINS
21 x TLED-U122



FLOOD BEAM
TRX-239 Box of 21

TECHNICAL SPECIFICATIONS

RAW LUMENS	1100 Lumens
EFFECTIVE LUMENS	750 Lumens
BEAM PATTERN	Flood Beam
DIODES	12 Diodes
OPERATING VOLTAGE	9-30 Volts
LED POWER	18 Watts
CURRENT DRAW	1.5 Amp @ 12 Volts
COLOR TEMPERATURE	6000 Kelvin
HOUSING MATERIAL	Aluminum Die Cast
BRACKET MATERIAL	Stainless Steel
LENS MATERIAL	Polycarbonate
WATERPROOF RATING	IP67 Rating
SOLD	Box of 21
WARRANTY	3 Years

BEAM PATTERN

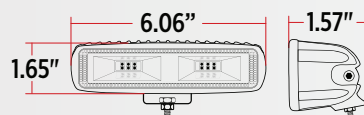
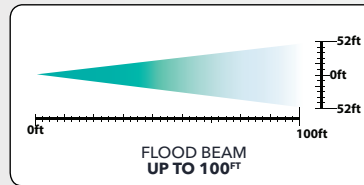

WIRING

2 WIRE CONNECTION



Connect the negative and positive work lamp wires to the corresponding negative and positive wires from the truck's wiring harness.

1100
LUMENS

FLOOD
BEAM

SOLD IN BOX OF
21 PCS

WARNING: Cancer and Reproductive Harm - www.p65warnings.ca.gov

3" MINI COMBINATION SPOT BEAM & FLOOD BEAM

**TOP
SELLER**

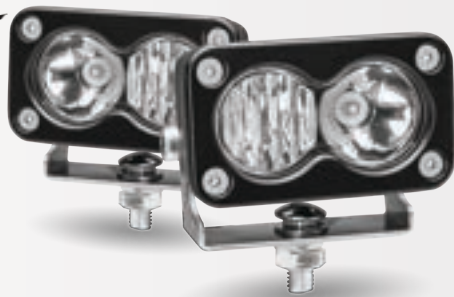

COMBINATION SPOT & FLOOD BEAM

TLED-U105

TECHNICAL SPECIFICATIONS

RAW LUMENS	900 Lumens
EFFECTIVE LUMENS	500 Lumens
BEAM PATTERN	Combination Spot & Flood Beam
DIODES	2 Diodes Each
OPERATING VOLTAGE	9-32 Volts
LED POWER	9 Watts
CURRENT DRAW	0.65 Amp @ 12 Volts
COLOR TEMPERATURE	6000 Kelvin
HOUSING MATERIAL	Aluminum Die Cast
BRACKET MATERIAL	Stainless Steel
LENS MATERIAL	Polycarbonate
WATERPROOF RATING	IP67 Rating
SOLD	As a Pair
WARRANTY	3 Years

BEAM PATTERN

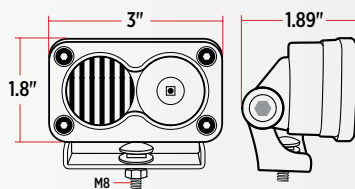
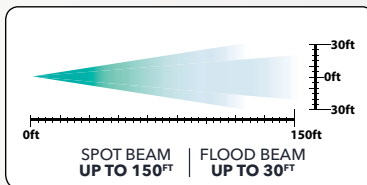

WIRING

2 WIRE CONNECTION



Connect the negative and positive work lamp wires to the corresponding negative and positive wires from the truck's wiring harness.

900
LUMENS

**SPOT &
FLOOD**
BEAM

SOLD IN
PAIRS

2.25" MINI HIGH POWERED SPOT BEAM



SPOT BEAM

TLED-U6

TECHNICAL SPECIFICATIONS

RAW LUMENS	1200 Lumens
EFFECTIVE LUMENS	800 Lumens
BEAM PATTERN	Spot Beam
DIODES	1 Diode
OPERATING VOLTAGE	10-30 Volts
LED POWER	10 Watts
CURRENT DRAW	0.82 Amps @ 12 Volts
COLOR TEMPERATURE	6000 Kelvin
HOUSING MATERIAL	Aluminum Die Cast
BRACKET MATERIAL	Stainless Steel
LENS MATERIAL	Polycarbonate
WATERPROOF RATING	IP67 Rating
SOLD	Individually
WARRANTY	3 Years

BEAM PATTERN

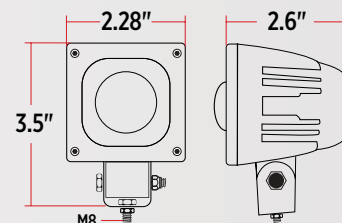
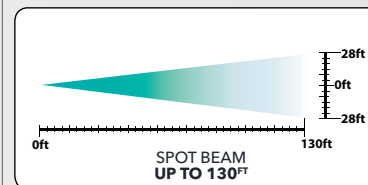

WIRING

2 WIRE CONNECTION



Connect the negative and positive work lamp wires to the corresponding negative and positive wires from the truck's wiring harness.

1200
LUMENS

SPOT
BEAM

LED WORK LAMPS

3" MINI STELLAR SERIES SPOT BEAM | FLOOD BEAM



SPOT BEAM
TLED-U89

TECHNICAL SPECIFICATIONS

RAW LUMENS	1500 Lumens
EFFECTIVE LUMENS	1200 Lumens
BEAM PATTERN	TLED-U89: Spot Beam TLED-U90: Flood Beam
DIODES	5 Diodes
OPERATING VOLTAGE	10-30 Volts
LED POWER	25 Watts
CURRENT DRAW	1.46 Amps @ 12 Volts
COLOR TEMPERATURE	6000 Kelvin
HOUSING MATERIAL	Aluminum Die Cast
BRACKET MATERIAL	Stainless Steel
LENS MATERIAL	Polycarbonate
WATERPROOF RATING	IP67 Rating
SOLD	Individually
WARRANTY	3 Years

BEAM PATTERN

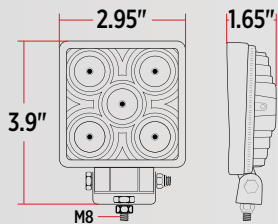
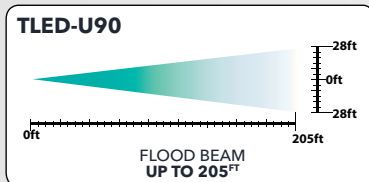
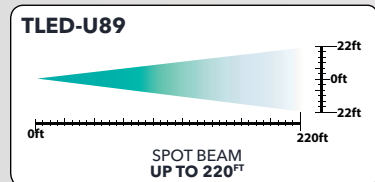

WIRING

2 WIRE CONNECTION



Connect the negative and positive work lamp wires to the corresponding negative and positive wires from the truck's wiring harness.

1500
LUMENS

SPOT BEAM
TLED-U89

FLOOD BEAM
TLED-U90

STELLAR
SERIES

3" MINI STANDARD SPOT BEAM | FLOOD BEAM



SPOT BEAM
TLED-U32

TECHNICAL SPECIFICATIONS

RAW LUMENS	1260 Lumens
EFFECTIVE LUMENS	900 Lumens
BEAM PATTERN	TLED-U32: Spot Beam TLED-U33: Flood Beam
DIODES	5 Diodes
OPERATING VOLTAGE	10-30 Volts
LED POWER	15 Watts
CURRENT DRAW	0.86 Amps @ 12 Volts
COLOR TEMPERATURE	6000 Kelvin
HOUSING MATERIAL	Aluminum Die Cast
BRACKET MATERIAL	Stainless Steel
LENS MATERIAL	Polycarbonate
WATERPROOF RATING	IP67 Rating
SOLD	Individually
WARRANTY	3 Years

BEAM PATTERN

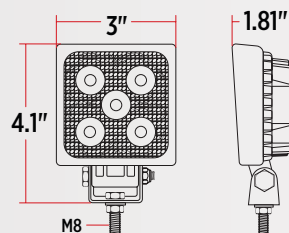
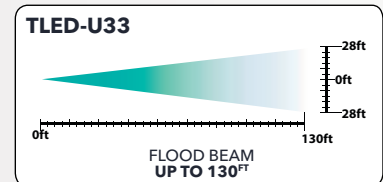
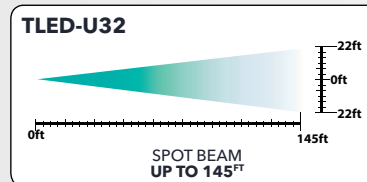

WIRING

2 WIRE CONNECTION



Connect the negative and positive work lamp wires to the corresponding negative and positive wires from the truck's wiring harness.

1260
LUMENS

SPOT BEAM
TLED-U32

FLOOD BEAM
TLED-U33

WARNING: Cancer and Reproductive Harm - www.p65warnings.ca.gov

4" STELLAR SERIES

SPOT BEAM | FLOOD BEAM



SPOT BEAM
TLED-U93

TECHNICAL SPECIFICATIONS

RAW LUMENS	1600 Lumens
EFFECTIVE LUMENS	1350 Lumens
BEAM PATTERN	TLED-U93: Spot Beam TLED-U94: Flood Beam
DIODES	9 Diodes
OPERATING VOLTAGE	10-30 Volts
LED POWER	27 Watts
CURRENT DRAW	2 Amps @ 12 Volts
COLOR TEMPERATURE	6000 Kelvin
HOUSING MATERIAL	Aluminum Die Cast
BRACKET MATERIAL	Stainless Steel
LENS MATERIAL	Polycarbonate
WATERPROOF RATING	IP67 Rating
SOLD	Individually
WARRANTY	3 Years

BEAM PATTERN

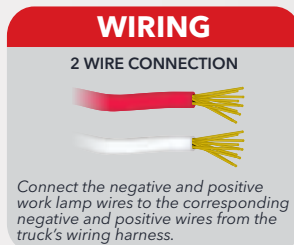
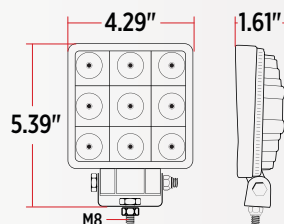
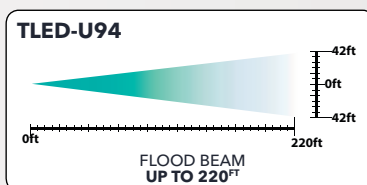
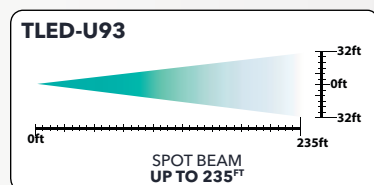

1600
LUMENS

SPOT BEAM
TLED-U93

FLOOD BEAM
TLED-U94

STELLAR
SERIES

WARNING: Cancer and Reproductive Harm - www.p65warnings.ca.gov

4" STANDARD

FLOOD BEAM



FLOOD BEAM
TLED-U2

TECHNICAL SPECIFICATIONS

RAW LUMENS	900 Lumens
EFFECTIVE LUMENS	500 Lumens
BEAM PATTERN	Flood Beam
DIODES	5 Diodes
OPERATING VOLTAGE	10-30 Volts
LED POWER	15 Watts
CURRENT DRAW	0.83 Amp @ 12 Volts
COLOR TEMPERATURE	6000 Kelvin
HOUSING MATERIAL	Aluminum Die Cast
BRACKET MATERIAL	Stainless Steel
LENS MATERIAL	Polycarbonate
WATERPROOF RATING	IP67 Rating
SOLD	Individually
WARRANTY	3 Years

BEAM PATTERN

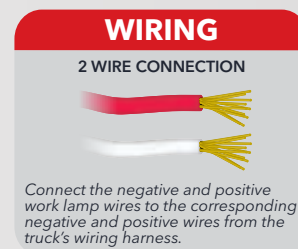
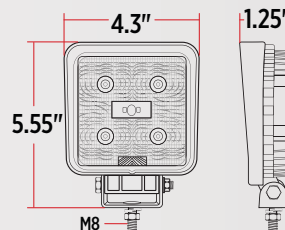
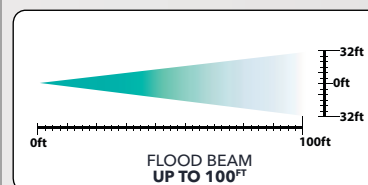

900
LUMENS

FLOOD
BEAM

LED WORK LAMPS

4.5" HIGH POWERED SPOT BEAM | FLOOD BEAM



SPOT BEAM
TLED-U5

FLOOD BEAM
TLED-U26

TECHNICAL SPECIFICATIONS

RAW LUMENS	1600 Lumens
EFFECTIVE LUMENS	900 Lumens
BEAM PATTERN	TLED-U5: Spot Beam TLED-U26: Flood Beam
DIODES	9 Diodes
OPERATING VOLTAGE	10-30 Volts
LED POWER	27 Watts
CURRENT DRAW	1.45 Amps @ 12 Volts
COLOR TEMPERATURE	6000 Kelvin
HOUSING MATERIAL	Aluminum Die Cast
BRACKET MATERIAL	Stainless Steel
LENS MATERIAL	Polycarbonate
WATERPROOF RATING	IP67 Rating
SOLD	Individually
WARRANTY	3 Years

BEAM PATTERN

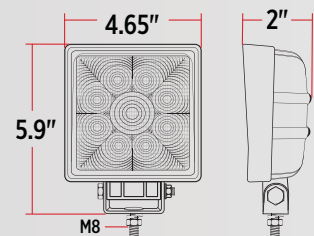
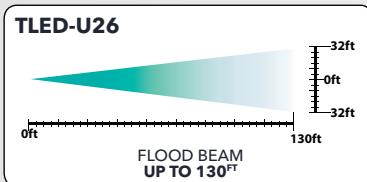
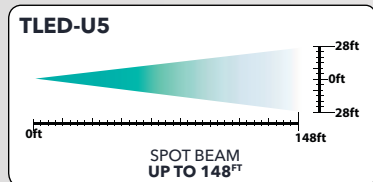

WIRING
2 WIRE CONNECTION

Connect the negative and positive work lamp wires to the corresponding negative and positive wires from the truck's wiring harness.

1600
LUMENS

SPOT BEAM
TLED-U5

FLOOD BEAM
TLED-U26

4.5" STELLAR SERIES HIGH POWERED SPOT BEAM | FLOOD BEAM



SPOT BEAM
TLED-U18

FLOOD BEAM
TLED-U27

TECHNICAL SPECIFICATIONS

RAW LUMENS	4000 Lumens
EFFECTIVE LUMENS	2400 Lumens
BEAM PATTERN	TLED-U18: Spot Beam TLED-U27: Flood Beam
DIODES	4 Diodes
OPERATING VOLTAGE	10-30 Volts
LED POWER	40 Watts
CURRENT DRAW	2.34 Amps @ 12 Volts
COLOR TEMPERATURE	6000 Kelvin
HOUSING MATERIAL	Aluminum Die Cast
BRACKET MATERIAL	Stainless Steel
LENS MATERIAL	Polycarbonate
WATERPROOF RATING	IP67 Rating
SOLD	Individually
WARRANTY	3 Years

BEAM PATTERN

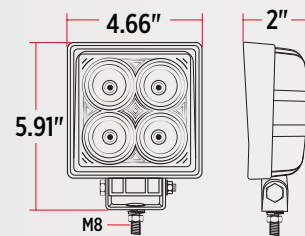
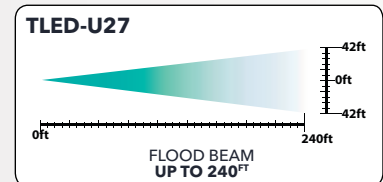
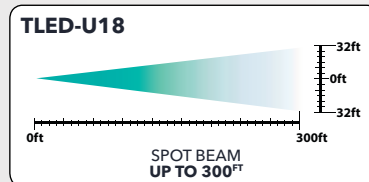

WIRING
2 WIRE CONNECTION

Connect the negative and positive work lamp wires to the corresponding negative and positive wires from the truck's wiring harness.

4000
LUMENS

SPOT BEAM
TLED-U18

FLOOD BEAM
TLED-U27

STELLAR
SERIES

WARNING: Cancer and Reproductive Harm - www.p65warnings.ca.gov

3" MINI STELLAR SERIES

SPOT BEAM | FLOOD BEAM



SPOT BEAM
TLED-U87

FLOOD BEAM
TLED-U88

TECHNICAL SPECIFICATIONS

RAW LUMENS	2000 Lumens
EFFECTIVE LUMENS	1200 Lumens
BEAM PATTERN	TLED-U87: Spot Beam TLED-U88: Flood Beam
DIODES	5 Diodes
OPERATING VOLTAGE	10-30 Volts
LED POWER	25 Watts
CURRENT DRAW	1.25~1.46 Amps @ 12 Volts
COLOR TEMPERATURE	6000 Kelvin
HOUSING MATERIAL	Aluminum Die Cast
BRACKET MATERIAL	Stainless Steel
LENS MATERIAL	Polycarbonate
WATERPROOF RATING	IP67 Rating
SOLD	Individually
WARRANTY	3 Years

BEAM PATTERN

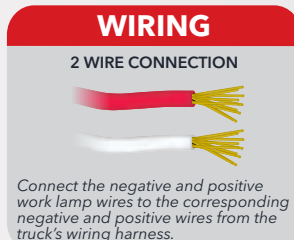
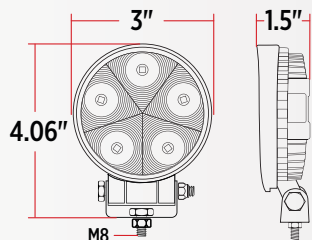
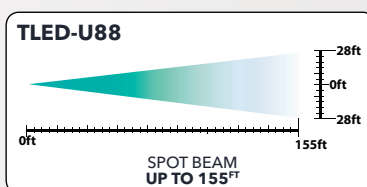
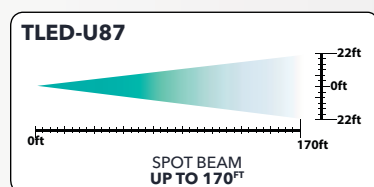

2000
LUMENS

SPOT BEAM
TLED-U87

FLOOD BEAM
TLED-U88

STELLAR
SERIES

3" MINI

SPOT BEAM | FLOOD BEAM



SPOT BEAM
TLED-U34

FLOOD BEAM
TLED-U35

TECHNICAL SPECIFICATIONS

RAW LUMENS	1260 Lumens
EFFECTIVE LUMENS	900 Lumens
BEAM PATTERN	TLED-U34: Spot Beam TLED-U35: Flood Beam
DIODES	5 Diodes
OPERATING VOLTAGE	10-30 Volts
LED POWER	15 Watts
CURRENT DRAW	0.69 Amps @ 12 Volts
COLOR TEMPERATURE	6000 Kelvin
HOUSING MATERIAL	Aluminum Die Cast
BRACKET MATERIAL	Stainless Steel
LENS MATERIAL	Polycarbonate
WATERPROOF RATING	IP67 Rating
SOLD	Individually
WARRANTY	3 Years

BEAM PATTERN

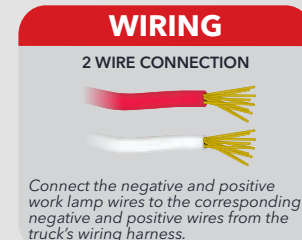
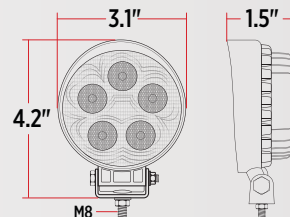
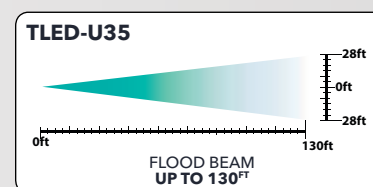
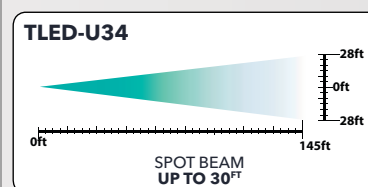

1260
LUMENS

SPOT BEAM
TLED-U34

FLOOD BEAM
TLED-U35

LED WORK LAMPS

4.5" STELLAR SERIES FLOOD BEAM



FLOOD BEAM TLED-U96

TECHNICAL SPECIFICATIONS

RAW LUMENS	1600 Lumens
EFFECTIVE LUMENS	1350 Lumens
BEAM PATTERN	Flood Beam
DIODES	9 Diodes
OPERATING VOLTAGE	10-30 Volts
LED POWER	27 Watts
CURRENT DRAW	2 Amps @ 12 Volts
COLOR TEMPERATURE	6000 Kelvin
HOUSING MATERIAL	Aluminum Die Cast
BRACKET MATERIAL	Stainless Steel
LENS MATERIAL	Polycarbonate
WATERPROOF RATING	IP67 Rating
SOLD	Individually
WARRANTY	3 Years

BEAM PATTERN

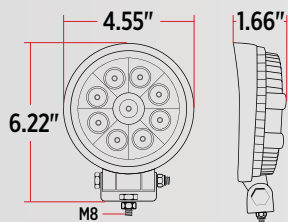
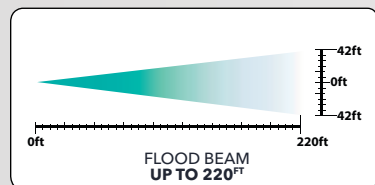

WIRING

2 WIRE CONNECTION



Connect the negative and positive work lamp wires to the corresponding negative and positive wires from the truck's wiring harness.

1600
LUMENS

FLOOD
BEAM

STELLAR
SERIES

4.5" STANDARD FLOOD BEAM



FLOOD BEAM TLED-U1

TECHNICAL SPECIFICATIONS

RAW LUMENS	1000 Lumens
EFFECTIVE LUMENS	600 Lumens
BEAM PATTERN	Flood Beam
DIODES	6 Diodes
OPERATING VOLTAGE	10-30 Volts
LED POWER	18 Watts
CURRENT DRAW	1.01 Amps @ 12 Volts
COLOR TEMPERATURE	6000 Kelvin
HOUSING MATERIAL	Aluminum Die Cast
BRACKET MATERIAL	Stainless Steel
LENS MATERIAL	Polycarbonate
WATERPROOF RATING	IP67 Rating
SOLD	Individually
WARRANTY	3 Years

BEAM PATTERN

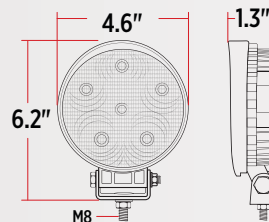
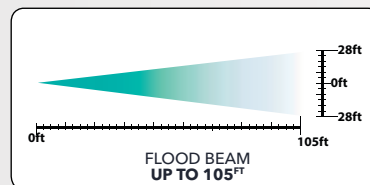

WIRING

2 WIRE CONNECTION



Connect the negative and positive work lamp wires to the corresponding negative and positive wires from the truck's wiring harness.

1000
LUMENS

FLOOD
BEAM

WARNING: Cancer and Reproductive Harm - www.p65warnings.ca.gov

5" HIGH POWERED SPOT BEAM | FLOOD BEAM



SPOT BEAM
TLED-U4

FLOOD BEAM
TLED-U25

TECHNICAL SPECIFICATIONS

RAW LUMENS	1600 Lumens
EFFECTIVE LUMENS	900 Lumens
BEAM PATTERN	TLED-U4: Spot Beam TLED-U25: Flood Beam
DIODES	9 Diodes
OPERATING VOLTAGE	10-30 Volts
LED POWER	27 Watts
CURRENT DRAW	1.39 Amps @ 12 Volts
COLOR TEMPERATURE	6000 Kelvin
HOUSING MATERIAL	Aluminum Die Cast
BRACKET MATERIAL	Stainless Steel
LENS MATERIAL	Polycarbonate
WATERPROOF RATING	IP67 Rating
SOLD	Individually
WARRANTY	3 Years

BEAM PATTERN

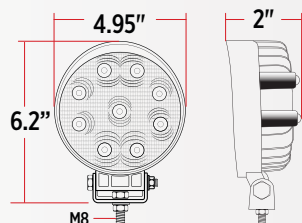
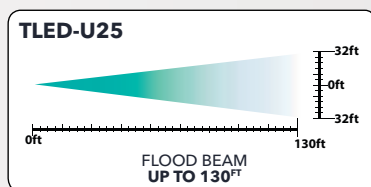
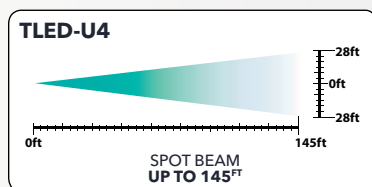

WIRING
2 WIRE CONNECTION

Connect the negative and positive work lamp wires to the corresponding negative and positive wires from the truck's wiring harness.

1600
LUMENS

SPOT BEAM
TLED-U4

FLOOD BEAM
TLED-U25

5" STELLAR SERIES HIGH POWERED SPOT BEAM | FLOOD BEAM



SPOT BEAM
TLED-U19

FLOOD BEAM
TLED-U28

TECHNICAL SPECIFICATIONS

RAW LUMENS	4200 Lumens
EFFECTIVE LUMENS	2400 Lumens
BEAM PATTERN	TLED-U19: Spot Beam TLED-U28: Flood Beam
DIODES	6 Diodes
OPERATING VOLTAGE	10-30 Volts
LED POWER	30 Watts
CURRENT DRAW	2.27 Amps @ 12 Volts
COLOR TEMPERATURE	6000 Kelvin
HOUSING MATERIAL	Aluminum Die Cast
BRACKET MATERIAL	Stainless Steel
LENS MATERIAL	Polycarbonate
WATERPROOF RATING	IP67 Rating
SOLD	Individually
WARRANTY	3 Years

BEAM PATTERN

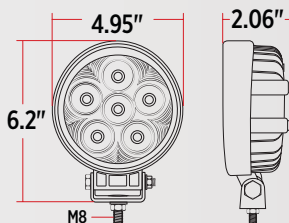
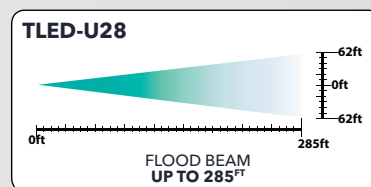
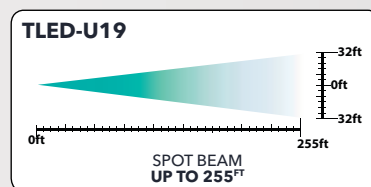

WIRING
2 WIRE CONNECTION

Connect the negative and positive work lamp wires to the corresponding negative and positive wires from the truck's wiring harness.

4200
LUMENS

SPOT BEAM
TLED-U19

FLOOD BEAM
TLED-U28

STELLAR
SERIES

LED WORK LAMPS

6" OVAL HIGH POWERED SPOT BEAM



SPOT BEAM TLED-U8

TECHNICAL SPECIFICATIONS

RAW LUMENS	3000 Lumens
EFFECTIVE LUMENS	2700 Lumens
BEAM PATTERN	Spot Beam
DIODES	3 Diodes
OPERATING VOLTAGE	10-30 Volts
LED POWER	30 Watts
CURRENT DRAW	2.24 Amps @ 12 Volts
COLOR TEMPERATURE	6000 Kelvin
HOUSING MATERIAL	Aluminum Die Cast
BRACKET MATERIAL	Stainless Steel
LENS MATERIAL	Polycarbonate
WATERPROOF RATING	IP67 Rating
SOLD	Individually
WARRANTY	3 Years

BEAM PATTERN

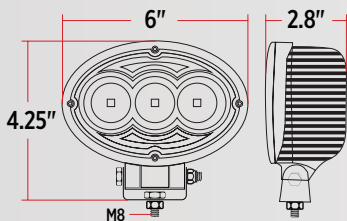
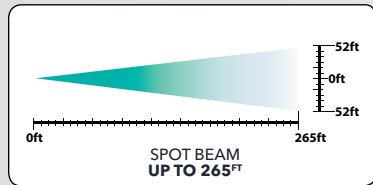

WIRING

2 WIRE CONNECTION

Connect the negative and positive work lamp wires to the corresponding negative and positive wires from the truck's wiring harness.

3000 LUMENS **SPOT BEAM**

6" OVAL SUPER POWERED SPOT BEAM | FLOOD BEAM

**TOP
SELLER**



SPOT BEAM TLED-U9

TECHNICAL SPECIFICATIONS

RAW LUMENS	6000 Lumens
EFFECTIVE LUMENS	5400 Lumens
BEAM PATTERN	TLED-U9: Spot Beam TLED-U29: Flood Beam
DIODES	6 Diodes
OPERATING VOLTAGE	10-30 Volts
LED POWER	60 Watts
CURRENT DRAW	4.34 Amps @ 12 Volts
COLOR TEMPERATURE	6000 Kelvin
HOUSING MATERIAL	Aluminum Die Cast
BRACKET MATERIAL	Stainless Steel
LENS MATERIAL	Polycarbonate
WATERPROOF RATING	IP67 Rating
SOLD	Individually
WARRANTY	3 Years

FLOOD BEAM TLED-U29

BEAM PATTERN

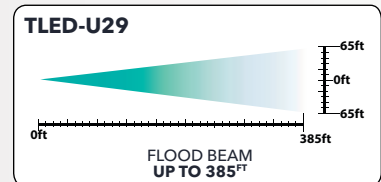
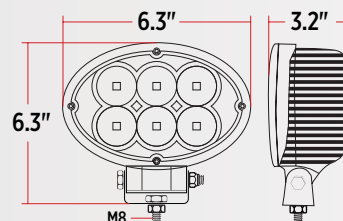
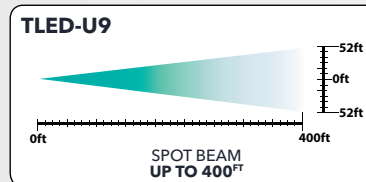

WIRING

2 WIRE CONNECTION

Connect the negative and positive work lamp wires to the corresponding negative and positive wires from the truck's wiring harness.

6000 LUMENS **SPOT BEAM TLED-U9** **FLOOD BEAM TLED-U29**

WARNING: Cancer and Reproductive Harm - www.p65warnings.ca.gov

6" RECTANGLE

SPOT BEAM | FLOOD BEAM



SPOT BEAM

TLED-U97

TECHNICAL SPECIFICATIONS

RAW LUMENS	1600 Lumens
EFFECTIVE LUMENS	1000 Lumens
BEAM PATTERN	Spot Beam
DIODES	6 Diodes
OPERATING VOLTAGE	10-30 Volts
LED POWER	18 Watts
CURRENT DRAW	0.51 Amps @ 12 Volts
COLOR TEMPERATURE	6000 Kelvin
HOUSING MATERIAL	Aluminum Die Cast
LENS MATERIAL	Polycarbonate
WATERPROOF RATING	IP67 Rating
SOLD	Individually
WARRANTY	3 Years

BEAM PATTERN

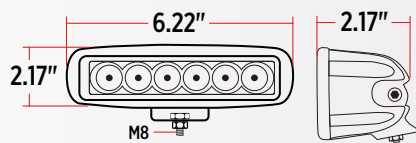
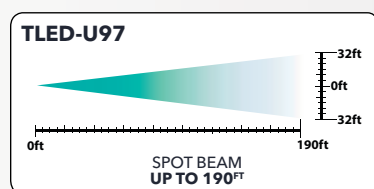

WIRING

2 WIRE CONNECTION



Connect the negative and positive work lamp wires to the corresponding negative and positive wires from the truck's wiring harness.

1600
LUMENS

SPOT
BEAM

STELLAR
SERIES

FLOOD BEAM

TLED-U98

TECHNICAL SPECIFICATIONS

RAW LUMENS	1600 Lumens
EFFECTIVE LUMENS	1000 Lumens
BEAM PATTERN	Flood Beam
DIODES	6 Diodes
OPERATING VOLTAGE	10-30 Volts
LED POWER	18 Watts
CURRENT DRAW	1.8 Amps @ 12 Volts
COLOR TEMPERATURE	6000 Kelvin
HOUSING MATERIAL	Aluminum Die Cast
LENS MATERIAL	Polycarbonate
WATERPROOF RATING	IP67 Rating
SOLD	Individually
WARRANTY	3 Years

BEAM PATTERN

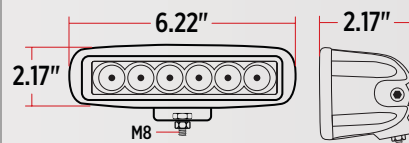
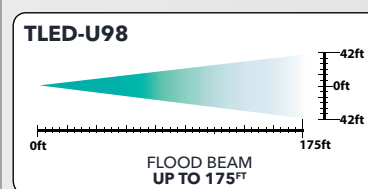

WIRING

2 WIRE CONNECTION



Connect the negative and positive work lamp wires to the corresponding negative and positive wires from the truck's wiring harness.

1600
LUMENS

FLOOD
BEAM

STELLAR
SERIES



LED WORK LAMPS

2.5" X 4.5" MINI SUPER POWERED SPOT BEAM



▲
SPOT BEAM
TLED-U10

TECHNICAL SPECIFICATIONS

RAW LUMENS	2400 Lumens
EFFECTIVE LUMENS	1600 Lumens
BEAM PATTERN	Spot Beam
DIODES	2 Diodes
OPERATING VOLTAGE	10-30 Volts
LED POWER	24 Watts
CURRENT DRAW	1.85 Amps @ 12 Volts
COLOR TEMPERATURE	6000 Kelvin
HOUSING MATERIAL	Aluminum Die Cast
BRACKET MATERIAL	Stainless Steel
LENS MATERIAL	Polycarbonate
WATERPROOF RATING	IP67 Rating
SOLD	Individually
WARRANTY	3 Years

BEAM PATTERN

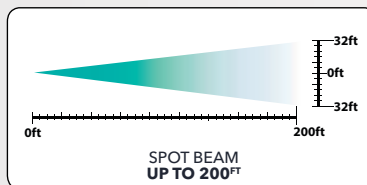

WIRING

2 WIRE CONNECTION



Connect the negative and positive work lamp wires to the corresponding negative and positive wires from the truck's wiring harness.

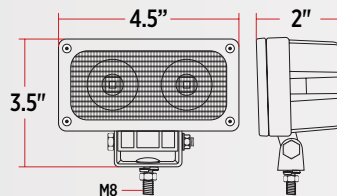

2400
LUMENS

SPOT
BEAM

4" X 6" STANDARD SPOT BEAM | FLOOD BEAM



SPOT BEAM
TLED-U21

FLOOD BEAM
TLED-U20

TECHNICAL SPECIFICATIONS

RAW LUMENS	660 Lumens
EFFECTIVE LUMENS	650 Lumens
BEAM PATTERN	TLED-U21: Spot Beam TLED-U20: Flood Beam
DIODES	6 Diodes
OPERATING VOLTAGE	12 Volts
LED POWER	17.4 Watts
CURRENT DRAW	1.45 Amps @ 12 Volts
COLOR TEMPERATURE	6000 Kelvin
HOUSING MATERIAL	Aluminum Die Cast
BRACKET MATERIAL	Stainless Steel
LENS MATERIAL	Polycarbonate
WATERPROOF RATING	IP67 Rating
SOLD	Individually
WARRANTY	3 Years

BEAM PATTERN

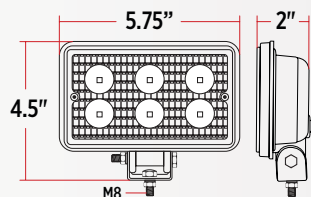
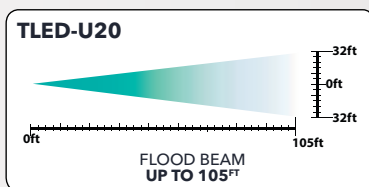
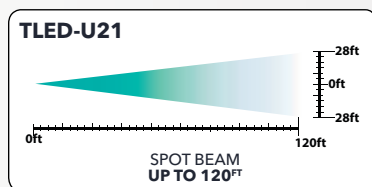

WIRING

2 WIRE CONNECTION

Connect the negative and positive work lamp wires to the corresponding negative and positive wires from the truck's wiring harness.

660
LUMENS

SPOT BEAM
TLED-U21

FLOOD BEAM
TLED-U20

4" X 6" HIGH POWERED SPOT BEAM | FLOOD BEAM

**TOP
SELLER**



SPOT BEAM
TLED-U40

FLOOD BEAM
TLED-U22

TECHNICAL SPECIFICATIONS

RAW LUMENS	1080 Lumens
EFFECTIVE LUMENS	970 Lumens
BEAM PATTERN	TLED-U40: Spot Beam TLED-U22: Flood Beam
DIODES	6 Diodes
OPERATING VOLTAGE	12 Volts
LED POWER	22.2 Watts
CURRENT DRAW	1.85 Amps @ 12 Volts
COLOR TEMPERATURE	6000 Kelvin
HOUSING MATERIAL	Aluminum Die Cast
BRACKET MATERIAL	Stainless Steel
LENS MATERIAL	Polycarbonate
WATERPROOF RATING	IP67 Rating
SOLD	Individually
WARRANTY	3 Years

BEAM PATTERN

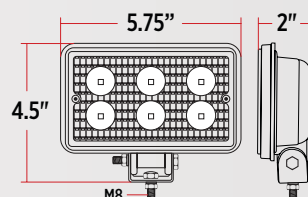
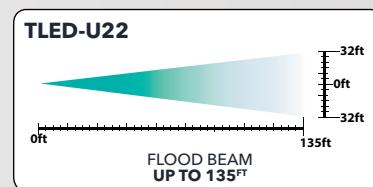
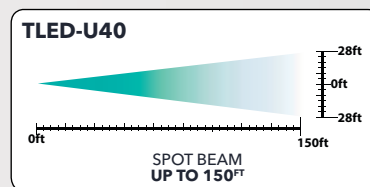

WIRING

2 WIRE CONNECTION

Connect the negative and positive work lamp wires to the corresponding negative and positive wires from the truck's wiring harness.

1080
LUMENS

SPOT BEAM
TLED-U40

FLOOD BEAM
TLED-U22

LED WORK LAMPS

7" HALF MOON SURFACE MOUNT | FLOOD BEAM

**TOP
SELLER**



FLOOD BEAM TLED-U108

TECHNICAL SPECIFICATIONS

RAW LUMENS	800 Lumens
EFFECTIVE LUMENS	780 Lumens
BEAM PATTERN	Flood Beam
DIODES	6 Diodes
OPERATING VOLTAGE	12-24 Volts
LED POWER	8 Watts
CURRENT DRAW	0.69 Amps @ 12 Volts
COLOR TEMPERATURE	6500 Kelvin
HOUSING MATERIAL	Aluminum Die Cast
LENS MATERIAL	Polycarbonate
WATERPROOF RATING	IP65 Rating
SOLD	Individually
WARRANTY	3 Years

BEAM PATTERN

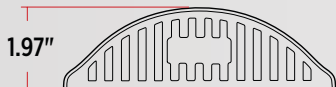
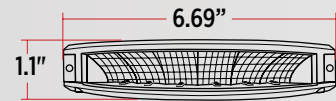
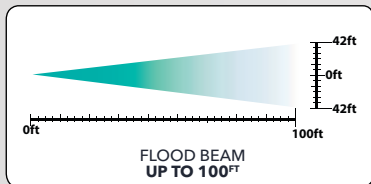

WIRING

2 WIRE CONNECTION



Connect the negative and positive work lamp wires to the corresponding negative and positive wires from the truck's wiring harness.

**800
LUMENS**

**FLOOD
BEAM**

SURFACE MOUNT COMBINATION SPOT BEAM & FLOOD BEAM



COMBINATION SPOT & FLOOD BEAM TLED-U49

TECHNICAL SPECIFICATIONS

RAW LUMENS	1600 Lumens
EFFECTIVE LUMENS	1000 Lumens
BEAM PATTERN	Combination Spot & Flood Beam
DIODES	4 Diodes
OPERATING VOLTAGE	10-30 Volts
LED POWER	16 Watts
CURRENT DRAW	0.94 Amps @ 12 Volts
COLOR TEMPERATURE	6000 Kelvin
HOUSING MATERIAL	Aluminum Die Cast
LENS MATERIAL	Polycarbonate
WATERPROOF RATING	IP67 Rating
SOLD	Individually
WARRANTY	3 Years

BEAM PATTERN

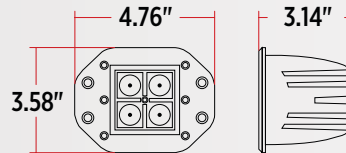
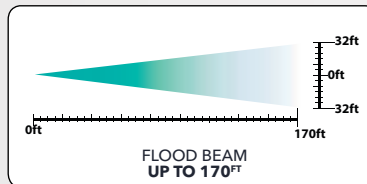

WIRING

2 WIRE CONNECTION



Connect the negative and positive work lamp wires to the corresponding negative and positive wires from the truck's wiring harness.

**1600
LUMENS**

**SPOT &
FLOOD
BEAM**

WARNING: Cancer and Reproductive Harm - www.p65warnings.ca.gov

4" GROMMET MOUNT FLOOD BEAM



FLOOD BEAM TLED-U16

TECHNICAL SPECIFICATIONS

RAW LUMENS	660 Lumens
EFFECTIVE LUMENS	650 Lumens
BEAM PATTERN	Flood Beam
DIODES	6 Diodes
OPERATING VOLTAGE	12 Volts
LED POWER	10.2 Watts
CURRENT DRAW	0.85 Amps @ 12 Volts
COLOR TEMPERATURE	6000 Kelvin
HOUSING MATERIAL	Aluminum Die Cast
LENS MATERIAL	Polycarbonate
WATERPROOF RATING	IP67 Rating
SOLD	Individually
WARRANTY	3 Years

BEAM PATTERN

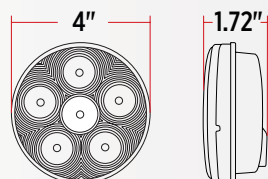
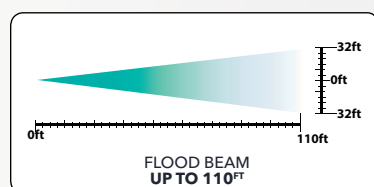

WIRING

3 PRONG ADAPTER



Assemble with any Triple
3 Prong Male Wire Harness.

660
LUMENS

FLOOD
BEAM

OVAL GROMMET MOUNT FLOOD BEAM



FLOOD BEAM TLED-U17

TECHNICAL SPECIFICATIONS

RAW LUMENS	660 Lumens
EFFECTIVE LUMENS	650 Lumens
BEAM PATTERN	Flood Beam
DIODES	6 Diodes
OPERATING VOLTAGE	12 Volts
LED POWER	10.2 Watts
CURRENT DRAW	0.85 Amps @ 12 Volts
COLOR TEMPERATURE	6000 Kelvin
HOUSING MATERIAL	Aluminum Die Cast
LENS MATERIAL	Polycarbonate
WATERPROOF RATING	IP67 Rating
SOLD	Individually
WARRANTY	3 Years

BEAM PATTERN

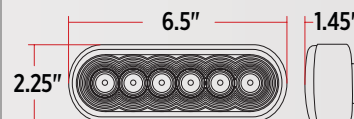
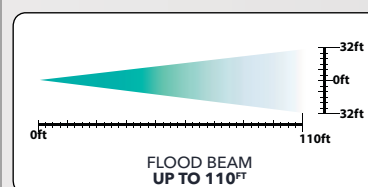

WIRING

3 PRONG ADAPTER



Assemble with any Triple
3 Prong Male Wire Harness.

660
LUMENS

FLOOD
BEAM

LED BEACON LIGHTS

MEDIUM PROFILE 1" PIPE MOUNT

NEW



AMBER SINGLE FLASH PATTERN

TLED-W1

TECHNICAL SPECIFICATIONS

FLASH PATTERN	Single Flash Pattern
RAW LUMENS	380 Lumens
EFFECTIVE LUMENS	110 Lumens
DIODES	3 Diodes
OPERATING VOLTAGE	12-24 Volts
LED POWER	6 Watts
CURRENT DRAW	0.5 Amps @ 12 Volts
COLOR TEMPERATURE	1800 Kelvin
HOUSING MATERIAL	Polycarbonate
LENS MATERIAL	Polycarbonate
WATERPROOF RATING	IP55 Rating
SOLD	Individually
WARRANTY	1 Year

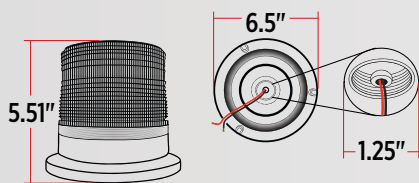

WIRING

2 WIRE CONNECTION



Connect the negative and positive work lamp wires to the corresponding negative and positive wires from the truck's wiring harness.

380
LUMENS

1 FLASH
PATTERN

PIPE
MOUNT

DOME VACCUM MAGNETIC MOUNT

NEW



AMBER - 3 FLASH PATTERN

TLED-W2

TECHNICAL SPECIFICATIONS

FLASH PATTERN	3 Flash Patterns
RAW LUMENS	960 Lumens
EFFECTIVE LUMENS	470 Lumens
DIODES	12 Diodes
OPERATING VOLTAGE	12-24 Volts
LED POWER	27 Watts
CURRENT DRAW	2 Amps @ 12 Volts
COLOR TEMPERATURE	1800 Kelvin
HOUSING MATERIAL	Polycarbonate
LENS MATERIAL	Polycarbonate
WATERPROOF RATING	IP55 Rating
SOLD	Individually
WARRANTY	1 Year

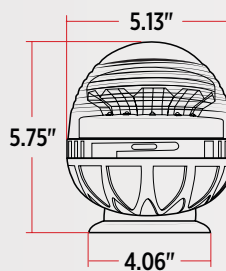

WIRING

CIGARETTE LIGHTER SOCKET ADAPTER



Connects to any Cigarette Lighter Socket.

960
LUMENS

3 FLASH
PATTERNS

VACCUM
MAGNETIC
MOUNT

LIGHT BAR PERMANENT MOUNT

NEW



TOP VIEW

AMBER - 3 FLASH PATTERN

TLED-W5

TECHNICAL SPECIFICATIONS

FLASH PATTERN	3 Flash Patterns
RAW LUMENS	1440 Lumens
EFFECTIVE LUMENS	700 Lumens
DIODES	18 Diodes
OPERATING VOLTAGE	12-24 Volts
LED POWER	27 Watts
CURRENT DRAW	2.3 Amps @ 12 Volts
COLOR TEMPERATURE	1800 Kelvin
HOUSING MATERIAL	Polycarbonate
LENS MATERIAL	Polycarbonate
WATERPROOF RATING	IP55 Rating
SOLD	Individually
WARRANTY	1 Year

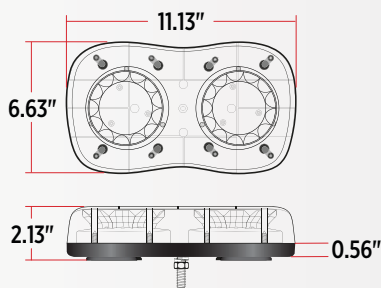

WIRING

2 WIRE CONNECTION & SWITCH



Refer to the Installation Instructions in the packaging for the wiring diagram.

1440
LUMENS

3 FLASH
PATTERNS

**PERMANENT
MOUNT**

WARNING: Cancer and Reproductive Harm - www.p65warnings.ca.gov

LED BEACON LIGHTS

MEDIUM PROFILE

1" PIPE / PERMANENT MOUNT
SINGLE FLASH PATTERN
380 LUMENS
12-24 VOLTS



TLED-W1

DOME

VACUUM MAGNETIC MOUNT
3 FLASH PATTERNS
960 LUMENS
12-24 VOLTS



TLED-W2

LIGHT BAR

PERMANENT MOUNT
3 FLASH PATTERNS
1440 LUMENS
12-24 VOLTS



TLED-W5

CLASS 1 STROBE SERIES

3 DIODES
24 FLASH PATTERNS

NEW



3 DIODES
TLED-W13A24

TECHNICAL SPECIFICATIONS

CLASSIFICATION	SAE J595 Class 1
COMPLIANCE	ECE R65, EMC R10, RoHS
FLASH PATTERNS	24 Flash Patterns
COLOR	Amber
DIODES	3 Diodes
OPERATING VOLTAGE	12-24 Volts
FUNCTIONS	1. Synchronization 2. Alternating Function 3. Last Pattern Recall
HOUSING MATERIAL	Aluminum Die Cast
LENS MATERIAL	Polycarbonate
WATERPROOF RATING	IP65 Rating
SOLD	Individually
WARRANTY	5 Years

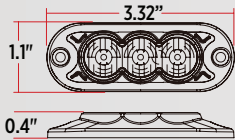

WIRING

- 4 WIRE CONNECTION
- GROUND
 - PATTERN SELECT
 - POWER
 - SYNCHRONIZATION

Refer to the Installation Instructions in the packaging for the wiring diagram.

CLASS 1
SAE J595

24
FLASH PATTERNS

L-BRACKET
INCLUDED

3M TAPE
INCLUDED

4 DIODES
26 FLASH PATTERNS

NEW



4 DIODES
TLED-W14A26

TECHNICAL SPECIFICATIONS

CLASSIFICATION	SAE J595 Class 1
COMPLIANCE	ECE R65, EMC R10, RoHS
FLASH PATTERNS	26 Flash Patterns
COLOR	Amber
DIODES	4 Diodes
OPERATING VOLTAGE	12-24 Volts
FUNCTIONS	1. Synchronization 2. Alternating Function 3. Last Pattern Recall
HOUSING MATERIAL	Aluminum Die Cast
LENS MATERIAL	Polycarbonate
WATERPROOF RATING	IP65 Rating
SOLD	Individually
WARRANTY	5 Years

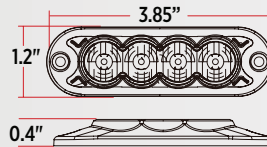

WIRING

- 4 WIRE CONNECTION
- GROUND
 - PATTERN SELECT
 - POWER
 - SYNCHRONIZATION

Refer to the Installation Instructions in the packaging for the wiring diagram.

CLASS 1
SAE J595

26
FLASH PATTERNS

L-BRACKET
INCLUDED

3M TAPE
INCLUDED

6 DIODES
26 FLASH PATTERNS

NEW



6 DIODES
TLED-W16A26

TECHNICAL SPECIFICATIONS

CLASSIFICATION	SAE J595 Class 1
COMPLIANCE	ECE R65, EMC R10, RoHS
FLASH PATTERNS	26 Flash Patterns
COLOR	Amber
DIODES	6 Diodes
OPERATING VOLTAGE	12-24 Volts
FUNCTIONS	1. Synchronization 2. Alternating Function 3. Last Pattern Recall
HOUSING MATERIAL	Aluminum Die Cast
LENS MATERIAL	Polycarbonate
WATERPROOF RATING	IP65 Rating
SOLD	Individually
WARRANTY	5 Years

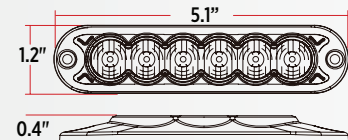

WIRING

- 4 WIRE CONNECTION
- GROUND
 - PATTERN SELECT
 - POWER
 - SYNCHRONIZATION

Refer to the Installation Instructions in the packaging for the wiring diagram.

CLASS 1
SAE J595

26
FLASH PATTERNS

L-BRACKET
INCLUDED

3M TAPE
INCLUDED

WARNING: Cancer and Reproductive Harm - www.p65warnings.ca.gov

3 DIODES
24 FLASH PATTERNS

NEW



▲
3 DIODES
TLED-W23A24

TECHNICAL SPECIFICATIONS

CLASSIFICATION	SAE J595 Class 1
COMPLIANCE	ECE R65, EMC R10, RoHS
FLASH PATTERNS	24 Flash Patterns
COLOR	Amber
DIODES	3 Diodes
OPERATING VOLTAGE	12-24 Volts
FUNCTIONS	1. Synchronization 2. Alternating Function 3. Last Pattern Recall
HOUSING MATERIAL	Aluminum Die Cast
LENS MATERIAL	Polycarbonate
WATERPROOF RATING	IP65 Rating
SOLD	Individually
WARRANTY	5 Years

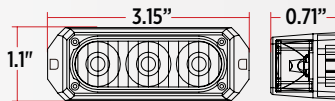

WIRING

4 WIRE CONNECTION

- GROUND
- PATTERN SELECT
- POWER
- SYNCHRONIZATION

Refer to the Installation Instructions in the packaging for the wiring diagram.

CLASS 1
SAE J595

24
FLASH PATTERNS

L-BRACKET
INCLUDED

4 DIODES
26 FLASH PATTERNS

NEW



▲
4 DIODES
TLED-W24A26

TECHNICAL SPECIFICATIONS

CLASSIFICATION	SAE J595 Class 1
COMPLIANCE	ECE R65, EMC R10, RoHS
FLASH PATTERNS	26 Flash Patterns
COLOR	Amber
DIODES	4 Diodes
OPERATING VOLTAGE	12-24 Volts
FUNCTIONS	1. Synchronization 2. Alternating Function 3. Last Pattern Recall
HOUSING MATERIAL	Aluminum Die Cast
LENS MATERIAL	Polycarbonate
WATERPROOF RATING	IP65 Rating
SOLD	Individually
WARRANTY	5 Years

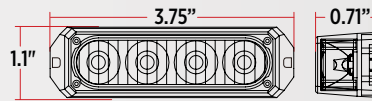

WIRING

4 WIRE CONNECTION

- GROUND
- PATTERN SELECT
- POWER
- SYNCHRONIZATION

Refer to the Installation Instructions in the packaging for the wiring diagram.

CLASS 1
SAE J595

26
FLASH PATTERNS

L-BRACKET
INCLUDED

6 DIODES
26 FLASH PATTERNS

NEW



▲
6 DIODES
TLED-W26A26

TECHNICAL SPECIFICATIONS

CLASSIFICATION	SAE J595 Class 1
COMPLIANCE	ECE R65, EMC R10, RoHS
FLASH PATTERNS	26 Flash Patterns
COLOR	Amber
DIODES	6 Diodes
OPERATING VOLTAGE	12-24 Volts
FUNCTIONS	1. Synchronization 2. Alternating Function 3. Last Pattern Recall
HOUSING MATERIAL	Aluminum Die Cast
LENS MATERIAL	Polycarbonate
WATERPROOF RATING	IP65 Rating
SOLD	Individually
WARRANTY	5 Years

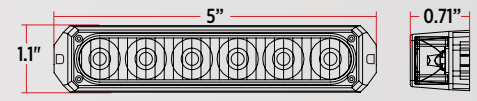

WIRING

4 WIRE CONNECTION

- GROUND
- PATTERN SELECT
- POWER
- SYNCHRONIZATION

Refer to the Installation Instructions in the packaging for the wiring diagram.

CLASS 1
SAE J595

26
FLASH PATTERNS

L-BRACKET
INCLUDED

LED WORK LAMPS

PAR4411 REPLACEMENT FLOOD BEAM



FLOOD BEAM
TLED-U47

TECHNICAL SPECIFICATIONS

RAW LUMENS	660 Lumens
EFFECTIVE LUMENS	650 Lumens
BEAM PATTERN	Flood Beam
DIODES	6 Diodes
OPERATING VOLTAGE	12 Volts
LED POWER	10.2 Watts
CURRENT DRAW	0.85 Amps @ 12 Volts
COLOR TEMPERATURE	6000 Kelvin
HOUSING MATERIAL	Aluminum Die Cast
LENS MATERIAL	Polycarbonate
WATERPROOF RATING	IP67 Rating
SOLD	Individually
WARRANTY	3 Years

BEAM PATTERN

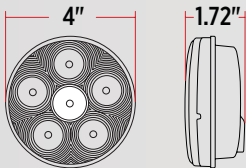
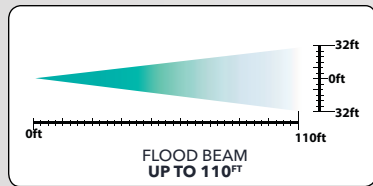

WIRING

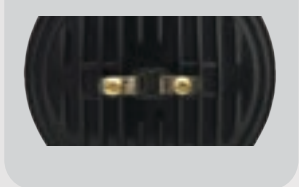

660
LUMENS

FLOOD
BEAM

FLASHLIGHT WITH 180° MAGNETIC CLIP - BOX OF 12



TLED-FLA1
BOX CONTAINS
12 x TLED-FLA1X



SPOT BEAM
TLED-FLA1 Box of 12

TECHNICAL SPECIFICATIONS

EFFECTIVE LUMENS	140 Lumens
HOUSING COLOR	Black & Grey
SOLD	Box of 12
WARRANTY	3 Years

140
LUMENS

180°
MAGNETIC
SWIVEL CLIP

BATTERIES
INCLUDED

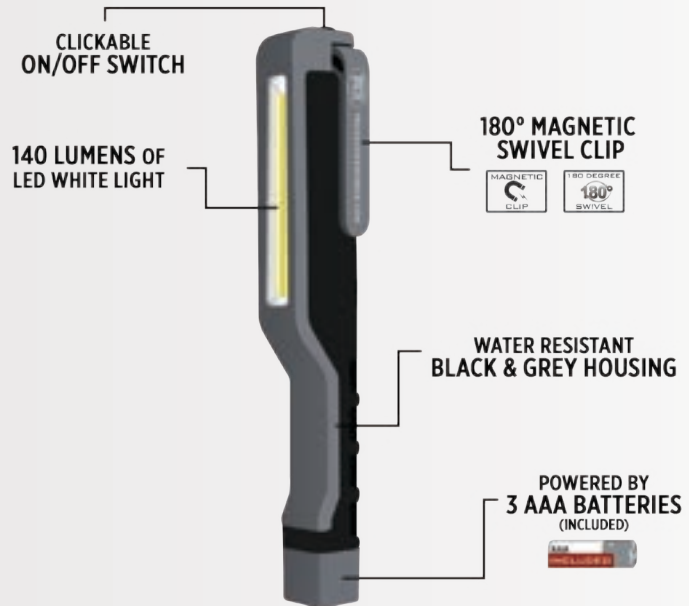

SINGLE ROW

COMBINATION SPOT & FLOOD BEAM

7"
TLED-U36 ▶



12"
TLED-U50 ▶



TECHNICAL SPECIFICATIONS

PART NUMBER	TLED-U36	TLED-U50
LENGTH	7"	12"
EFFECTIVE LUMENS	1260 Lumens	2520 Lumens
DIODES	6 Diodes	12 Diodes
OPERATING VOLTAGE	9-32 Volts	10-30 Volts
LED POWER	18 Watts	36 Watts
CURRENT DRAW	1.05 Amps @ 12 Volt	2.1 Amps @ 12 Volts
PRODUCT DIMENSIONS	6.875" x 2" x 2.125"	12" x 1.77" x 2.18"
WARRANTY	3 Years	3 Years

FEATURES & BENEFITS

- ▶ Spot & Flood Beam Pattern
- ▶ Wire Harness & Bracket Included
- ▶ IP67 Waterproof Rating
- ▶ 6000 Kelvin Color Temperature
- ▶ Strong & Durable Polycarbonate Lens
- ▶ Sold Individually
- ▶ 3 Year Warranty

WIRING

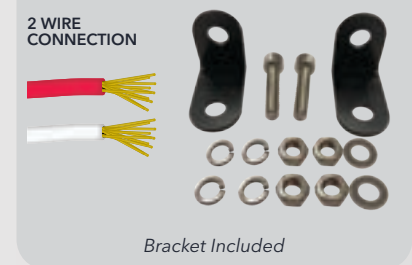

BEAM PATTERN

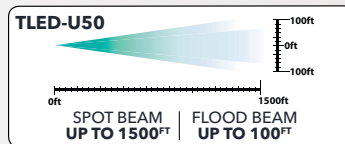
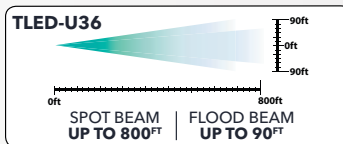

SPOT &
FLOOD
BEAM

BRACKET
INCLUDED

ROUND TUBE MOUNTING BRACKETS (PAIR)

FOR LED LIGHT BARS



- ◀ ROUND MOUNTING BRACKETS
- TU-1046** 1" Diameter
 - TU-1047** 1.25" Diameter
 - TU-1048** 1.5" Diameter
 - TU-1049** 1.75" Diameter
 - TU-1050** 2" Diameter
 - TU-1051** 3" Diameter

TECHNICAL SPECIFICATIONS

KIT INCLUDES	2 x Brackets 2 x Allen Keys 2 x Adhesive Foam Pads
DESIGNED TO FIT	Bar Diameter based on Part Number
MATERIAL	Steel
WARRANTY	3 Years

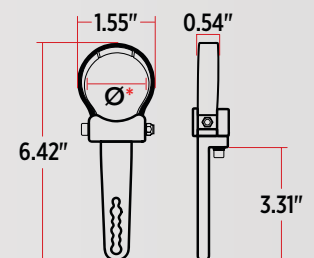

∅* Diameter varies based on Part Number.

LED LIGHT BARS

DOUBLE ROW COMBINATION SPOT & FLOOD BEAM

14"
TLED-U65 ▶



22"
TLED-U66 ▶



32"
TLED-U67 ▶



42"
TLED-U68 ▶



50"
TLED-U69 ▶



FEATURES & BENEFITS

- ▶ Spot & Flood Beam Pattern
- ▶ Wire Harness & Bracket Included
- ▶ 10-30 Volt Operating Voltage
- ▶ IP67 Waterproof Rating
- ▶ 6000 Kelvin Color Temperature
- ▶ Strong & Durable Polycarbonate Lens
- ▶ Sold Individually
- ▶ 3 Year Warranty

TECHNICAL SPECIFICATIONS

PART NUMBER	TLED-U65	TLED-U66	TLED-U67	TLED-U68	TLED-U69
LENGTH	14"	22"	32"	42"	50"
RAW LUMENS	7200 Lumens	12000 Lumens	18000 Lumens	24000 Lumens	28800 Lumens
EFFECTIVE LUMENS	2880 Lumens	4800 Lumens	7600 Lumens	9600 Lumens	11520 Lumens
DIODES	24 Diodes	40 Diodes	60 Diodes	80 Diodes	96 Diodes
OPERATING VOLTAGE	10-30 Volts	10-30 Volts	10-30 Volts	10-30 Volts	10-30 Volts
LED POWER	48 Watts	80 Watts	120 Watts	160 Watts	192 Watts
CURRENT DRAW	4 Amps @ 12 Volt	6.67 Amps @ 12 Volts	10 Amps @ 12 Volts	13.33 Amps @ 12 Volts	16 Amps @ 12 Volts
PRODUCT DIMENSIONS	16.5" x 3.5" x 4.5"	24.63" x 3.5" x 4.5"	34.5" x 3.5" x 4.5"	44.5" x 3.5" x 4.5"	52.63" x 3.5" x 4.5"
WARRANTY	3 Years	3 Years	3 Years	3 Years	3 Years

BEAM PATTERN

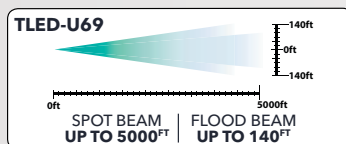
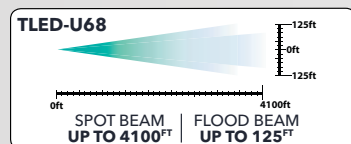
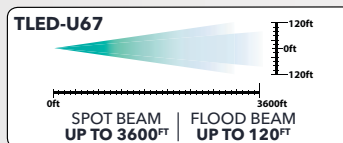
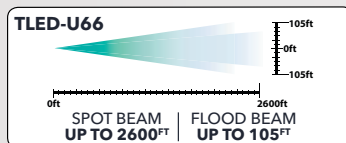
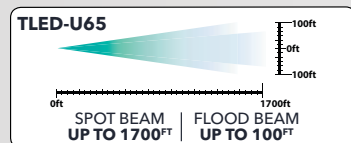

SPOT & FLOOD BEAM

WIRE HARNESS & BRACKET INCLUDED

WIRING

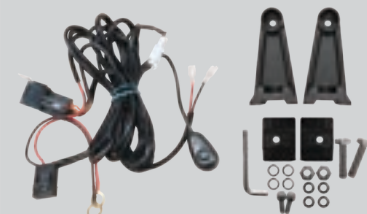

Refer to the Installation Instructions in the packaging for the wiring diagram.

⚠ WARNING: Cancer and Reproductive Harm - www.p65warnings.ca.gov

DOUBLE ROW WITH COVER

COMBINATION SPOT & FLOOD BEAM

15"
TLED-U86 ▶



22"
TLED-U76 ▶



32"
TLED-U77 ▶



FEATURES & BENEFITS

- ▶ Spot & Flood Beam Pattern
- ▶ Integrated Locking Pin Cover
- ▶ Wire Harness & Bracket Included
- ▶ 10-30 Volt Operating Voltage
- ▶ IP67 Waterproof Rating
- ▶ 6000 Kelvin Color Temperature
- ▶ Strong & Durable Polycarbonate Lens
- ▶ Sold Individually
- ▶ 3 Year Warranty

TECHNICAL SPECIFICATIONS

PART NUMBER	TLED-U86	TLED-U76	TLED-U77
LENGTH	15"	22"	32"
RAW LUMENS	7200 Lumens	12000 Lumens	18000 Lumens
EFFECTIVE LUMENS	5040 Lumens	8400 Lumens	12600 Lumens
DIODES	24 Diodes	40 Diodes	60 Diodes
OPERATING VOLTAGE	10-30 Volts	10-30 Volts	10-30 Volts
LED POWER	72 Watts	120 Watts	180 Watts
CURRENT DRAW	4 Amps @ 12 Volt	8.2 Amps @ 12 Volts	13 Amps @ 12 Volts
PRODUCT DIMENSIONS	17.38" x 3.5" x 4.5"	24.63" x 3.5" x 4.5"	34.5" x 3.5" x 4.5"
WARRANTY	3 Years	3 Years	3 Years

BEAM PATTERN

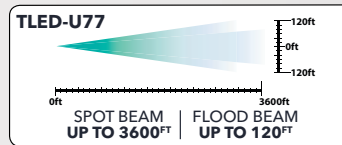
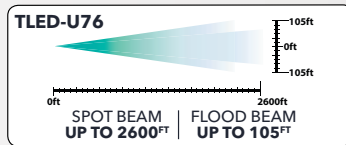
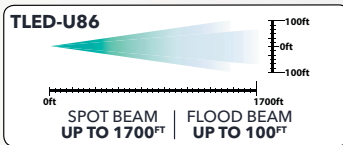

WIRING

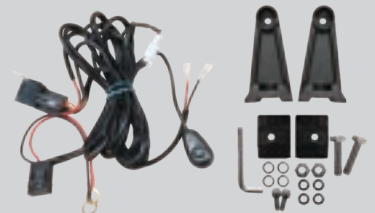

Refer to the Installation Instructions in the packaging for the wiring diagram.

SPOT & FLOOD BEAM

WIRE HARNESS & BRACKET INCLUDED



SOLD IN RETAIL PACKAGING

⚠ WARNING: Cancer and Reproductive Harm - www.p65warnings.ca.gov

MULTI FUNCTIONALITY AT ITS PEAK!

No light has ever been this cleverly designed! Bringing the revolutionary to the Trux's Dual Revolution line is the latest TLED-OX60RAS & TLED-4X40AS. At the peak of multi-functionality, this Red Stop, Turn & Tail to Amber Multi Pulse Strobe is the most ALL-IN-ONE light ever created. These bad boys have you seen in a flick of a switch!

**INTRODUCING
DUAL FUNCTION LEDS
WITH STROBE**

OVAL



TLED-OX60RAS

4"



TLED-4X40AS



RED STOP, TURN & TAIL



AMBER STROBE

Not only are they unique, they're also cost-effective and designed to outperform in any industry:



WIDE LOAD VEHICLES



WRECKERS



SERVICE VEHICLES



DELIVERY VEHICLES

4" ROUND STROBE - 19 LEDS GROMMET MOUNT - S, T & T TO STROBE

NEW



RED S, T & T TO AMBER STROBE
TLED-4X40AS

TECHNICAL SPECIFICATIONS

DOT/SAE	DOT To Strobe
DIODES	19 Diodes
FUNCTION	Function 1: Stop, Turn & Tail Function 2: Strobe
CURRENT DRAW	Function 1: 270 mA Function 2: 220 mA~247 mA
LENS MATERIAL	Polycarbonate
WARRANTY	3 Years

ACCESSORY OPTIONS

GROMMETS (pg. 115)	TGRO-4R, TGRO-4RC
WIRE HARNESS (pg.117-118)	B612, S Series, TPIG-3W
BEZELS (pg. 113-114)	TBEZ-4LR, TBEZ-4CH2, TBEZ-4CH3, TBEZ-4CH4, TBEZ-4CH5



CASE QTY.
100 PCS



INNER BOX QTY.
20 PCS

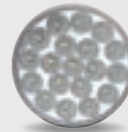

OFF



WIRING

3 PRONG & BULLET PLUG



S, T & T



STROBE

Assemble with any standard 3 Prong Pigtail and Single Female Wire Harness.

6" OVAL STROBE - 12 LEDS GROMMET MOUNT - S, T & T TO STROBE

NEW

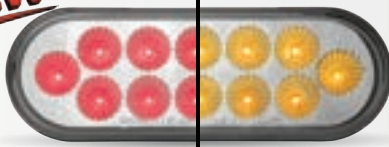

RED S, T & T TO AMBER STROBE
TLED-OX60RAS

TECHNICAL SPECIFICATIONS

DOT/SAE	DOT To Strobe
DIODES	12 Diodes
FUNCTION	Function 1: Stop, Turn & Tail Function 2: Strobe
CURRENT DRAW	Function 1: 145 mA Function 2: 145 mA
LENS MATERIAL	Polycarbonate
WARRANTY	3 Years

ACCESSORY OPTIONS

GROMMETS	TGRO-OBR, TGRO-OBRC (pg. 115)
WIRE HARNESS	B612, S Series, TPIG-3W (pg. 116-118)
BEZELS	TBEZ-OLR, TBEZ-OBCH2, TBEZ-OBCH3, TBEZ-OBCH4, TBEZ-OBCH5 (pg. 114)

WIRING

3 PRONG & BULLET PLUG

S, T & T

STROBE

Assemble with any standard 3 Prong Pigtail and Single Female Wire Harness.

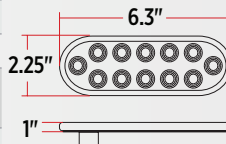

CASE QTY.
100 PCS



INNER BOX QTY.
20 PCS

6" OVAL STROBE - 12 LEDS GROMMET MOUNT - MARKER TO STROBE

NEW



AMBER STROBE
TLED-OX60AS

TECHNICAL SPECIFICATIONS

DOT/SAE	DOT To Strobe
DIODES	12 Diodes
FUNCTION	Strobe
CURRENT DRAW	Function 1: 145 mA Function 2: 145 mA
LENS MATERIAL	Polycarbonate
WARRANTY	3 Years

ACCESSORY OPTIONS

GROMMETS	TGRO-OBR, TGRO-OBRC (pg. 115)
WIRE HARNESS	B612, S Series, TPIG-3W (pg. 116-118)
BEZELS	TBEZ-OLR, TBEZ-OBCH2, TBEZ-OBCH3, TBEZ-OBCH4, TBEZ-OBCH5 (pg. 114)

WIRING

3 PRONG & BULLET PLUG

TURN & MARKER

STROBE

Assemble with any standard 3 Prong Pigtail and Single Female Wire Harness.

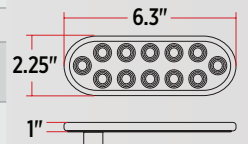

CASE QTY.
100 PCS



INNER BOX QTY.
20 PCS

DUAL REVOLUTION LED

4" ROUND - 19 LEDS GROMMET | FLANGE MOUNT - S, T & T TO BACK UP



FUNCTION 1
RED STOP, TURN & TAIL

FUNCTION 2
WHITE BACK UP

TECHNICAL SPECIFICATIONS

DOT/SAE	Compliant	CURRENT DRAW	Function 1: 270 mA Function 2: 220 mA
DIODES	19 Diodes	LENS MATERIAL	Polycarbonate
FUNCTION	Function 1: Stop, Turn & Tail Function 2: Back Up	WARRANTY	3 Years

FEATURES & BENEFITS

- 2 Functions in 1 light
- Revolutionary Technology
- Easy Installation
- Greater visibility with **WHITE BACK UP** Function
- Grommet & Flange Mount Models

MEASUREMENTS

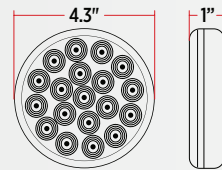

4X40 WIRING

3 PRONG & BULLET PLUG



Assemble with any standard 3 Prong Pigtail and Single Female Harness.

WIRING
S, T & T
BACK UP

3 PRONG WITH EXTRA BULLET PLUG
TLED-4X40 Grommet

INCLUDES EXTENSION

SUPER SEAL ADAPTER
TLED-4X40T Grommet

INCLUDES EXTENSION

LOCK CONNECTOR ADAPTER
TLED-4X40G Grommet

WIRING
S, T & T
BACK UP

3 FEMALE PRONG ADAPTER
TLED-4X40F Flange Mount

ACCESSORY OPTIONS

GROMMETS (pg. 115)	TGRO-4R, TGRO-4RC
WIRE HARNESS (pg.116-118)	B612, S Series, TPIG-3W
BEZELS (pg. 113-114)	TBEZ-4CH2, TBEZ-4CH3, TBEZ-4CH4, TBEZ-4CH5, TBEZ-4LR

TLED-4X40, TLED-4X40T,
TLED-4X40G:

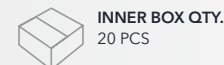

TLED-4X40F:

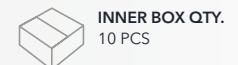

⚠ WARNING: Cancer and Reproductive Harm - www.p65warnings.ca.gov

TOP SELLER 4" ROUND S, T & T TO BACK UP LEDS ARE NOW AVAILABLE IN A POS BOX

TRX-237

SEE PAGE 314 FOR MORE INFORMATION



6" OVAL - 12 LEDS GROMMET MOUNT - S, T & T TO BACK UP

**TOP
SELLER**

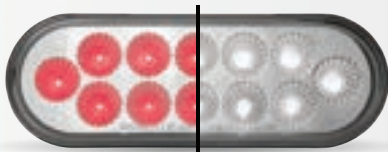

RED S, T & T TO WHITE BACK UP
TLED-OX60R

TECHNICAL SPECIFICATIONS

DOT/SAE	Compliant
DIODES	12 Diodes
FUNCTION	Function 1: Stop, Turn & Tail Function 2: Back Up
CURRENT DRAW	Function 1: 145 mA Function 2: 132 mA
LENS MATERIAL	Polycarbonate
WARRANTY	3 Years

ACCESSORY OPTIONS

GROMMETS	TGRO-OBR, TGRO-OBRC (pg. 115)
WIRE HARNESS	B612, S Series, TPIG-3W (pg. 116-118)
BEZELS	TBEZ-OLR, TBEZ-OBCH2, TBEZ-OBCH3, TBEZ-OBCH4, TBEZ-OBCH5 (pg. 114)

WIRING

3 PRONG & BULLET PLUG

S, T & T

BACK UP

Assemble with any standard 3 Prong Pigtail and Single Female Wire Harness.

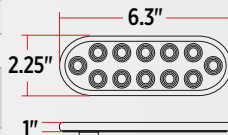

CASE QTY.
100 PCS



INNER BOX QTY.
20 PCS

3/4" ROUND - 2 LEDS GROMMET MOUNT - S, T & T TO BACK UP



RED S, T & T TO WHITE BACK UP
TLED-BX40

TECHNICAL SPECIFICATIONS

DOT/SAE	Compliant
DIODES	2 Diodes
FUNCTION	Function 1: Stop, Turn & Tail Function 2: Back Up
CURRENT DRAW	Function 1: 30 mA Function 2: 28 mA
LENS MATERIAL	Polycarbonate
WARRANTY	3 Years

ACCESSORY OPTIONS

WIRE HARNESS	T Series, S Series (pg. 117-118)
--------------	----------------------------------

WIRING

4 BULLET PLUGS

TURN/STOP

TAIL

GROUND

BACK UP

Assemble with any Triple Female Wire Harness and Single Female Wire Harness.

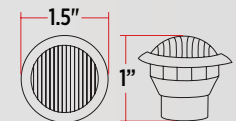

CASE QTY.
100 PCS

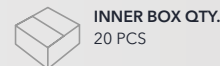

INNER BOX QTY.
20 PCS

DUAL REVOLUTION LED

4" FLATLINE - 49 LEDS FLANGE MOUNT - S, T & T TO BACK UP

[PATENTED DESIGN]



RED S, T & T TO WHITE BACK UP
TLED-FX72

TECHNICAL SPECIFICATIONS

DIODES	49 Diodes
FUNCTION	Function 1: Stop, Turn & Tail Function 2: Auxiliary
CURRENT DRAW	250 mA
LENS MATERIAL	Polycarbonate
WARRANTY	3 Years

ACCESSORY OPTIONS

WIRE HARNESS	B612, S Series, TPIG-3W (pg. 116-118)
--------------	------------------------------------------

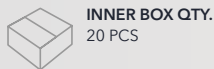

WIRING

3 PRONG & BULLET PLUG



Assemble with any standard 3 Prong Pigtail and Single Female Wire Harness.

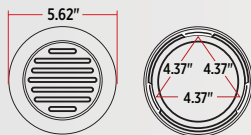

4" FLATLINE - 49 LEDS GROMMET MOUNT - S, T & T TO BACK UP

[PATENTED DESIGN]

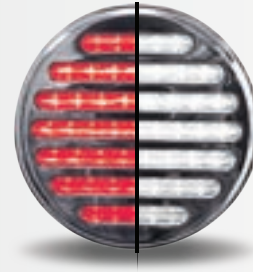

RED S, T & T TO WHITE BACK UP
TLED-FX73

TECHNICAL SPECIFICATIONS

DIODES	49 Diodes
FUNCTION	Function 1: Stop, Turn & Tail Function 2: Auxiliary
CURRENT DRAW	138 mA
LENS MATERIAL	Polycarbonate
WARRANTY	3 Years

ACCESSORY OPTIONS

WIRE HARNESS	B612, S Series, TPIG-3W (pg. 116-118)
--------------	------------------------------------------

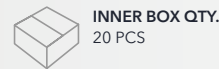

WIRING

3 PRONG & BULLET PLUG



Assemble with any standard 3 Prong Pigtail and Single Female Wire Harness.

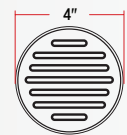

6" SLIM - 9 LEDS S, T & T TO AUXILIARY

[PATENTED DESIGN]

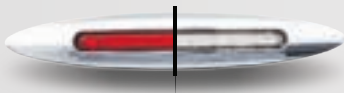

RED S, T & T TO WHITE AUX.
TLED-FX76

TECHNICAL SPECIFICATIONS

DIODES	9 Diodes
FUNCTION	Function 1: Stop, Turn & Tail Function 2: Auxiliary
CURRENT DRAW	Function 1: 50 mA Function 2: 70 mA
LENS MATERIAL	Polycarbonate
WARRANTY	3 Years

ACCESSORY OPTIONS

WIRE HARNESS	T Series (pg. 118)
--------------	--------------------



WIRING

3 BULLET PLUGS & TERMINAL



Assemble with any Triple Female Wire Harness.

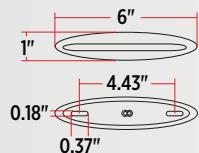

17" SLIM - 24 LEDS S, T & T TO AUXILIARY

RED S, T & T TO WHITE AUX.
TLED-FX78

TECHNICAL SPECIFICATIONS

DIODES	24 Diodes
FUNCTION	Function 1: Stop, Turn & Tail Function 2: Auxiliary
CURRENT DRAW	Function 1: 150 mA Function 2: 170 mA
LENS MATERIAL	Polycarbonate
WARRANTY	3 Years

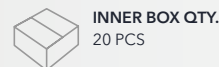

WIRING

4 WIRES

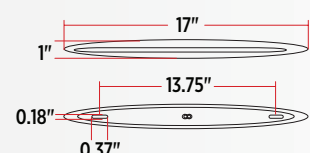

⚠ WARNING: Cancer and Reproductive Harm - www.p65warnings.ca.gov

FROM ROAD TO SHOW TWO COLORS IN ONE LIGHT

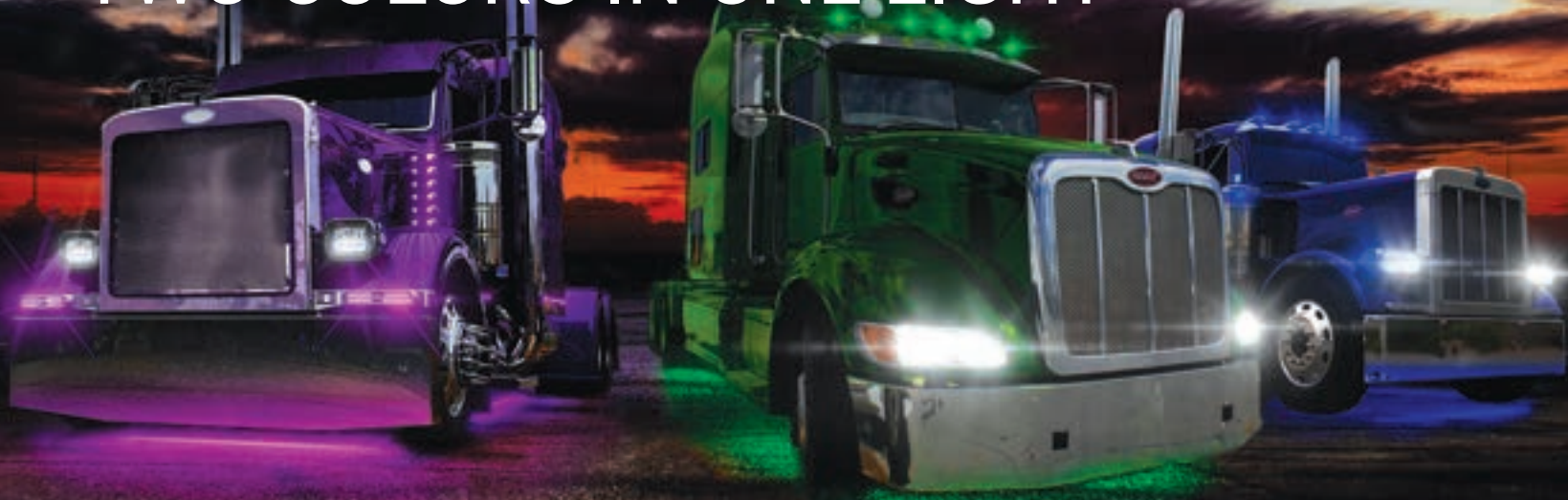

DOT COMPLIANT
RED | AMBER
STOP, TURN & TAIL | TURN SIGNAL & MARKER



AUXILIARY
GREEN | PURPLE | BLUE
RED | AMBER | WHITE



DOT COMPLIANT
FUNCTION

AUXILIARY
FUNCTION

DUAL REVOLUTION
ALL-IN-ONE LEDS

DUAL REVOLUTION LED

**TOP
SELLER**

4" ROUND - 19 LEDS GROMMET MOUNT - S, T & T TO AUXILIARY

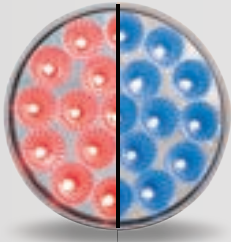

RED S, T & T TO BLUE AUX.
TLED-4XRB

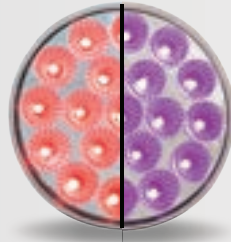

RED S, T & T TO PURPLE AUX.
TLED-4XRP

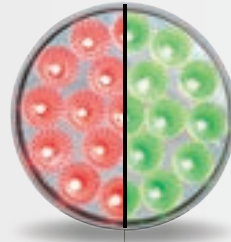

RED S, T & T TO GREEN AUX.
TLED-4XRG

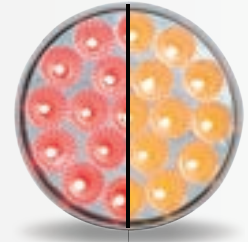

RED S, T & T TO AMBER AUX.
TLED-4X40A

TECHNICAL SPECIFICATIONS

DOT/SAE	DOT To Auxiliary
DIODES	19 Diodes
FUNCTION	Function 1: Stop, Turn & Tail Function 2: Auxiliary
CURRENT DRAW	Function 1: 270 mA Function 2: 220 mA~247 mA
LENS MATERIAL	Polycarbonate
WARRANTY	3 Years

ACCESSORY OPTIONS

GROMMETS (pg. 115)	TGRO-4R, TGRO-4RC
WIRE HARNESS (pg.116-118)	B612, S Series, TPIG-3W
BEZELS (pg. 113-114)	TBEZ-4LR, TBEZ-4CH2, TBEZ-4CH3, TBEZ-4CH4, TBEZ-4CH5



CASE QTY.
100 PCS

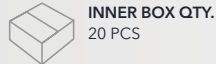

INNER BOX QTY.
20 PCS

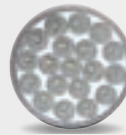

OFF

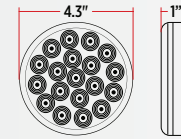

WIRING

3 PRONG & BULLET PLUG

S, T & T
AUX.

*Assemble with any standard
3 Prong Pigtail and Single
Female Wire Harness.*

4" ROUND - 19 LEDS GROMMET MOUNT - TURN & MARKER TO AUXILIARY

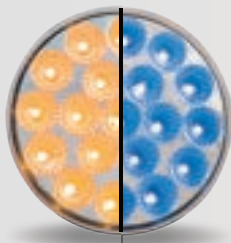

AMBER TURN & MARKER TO BLUE AUX.
TLED-4XAB

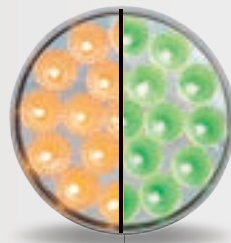

AMBER TURN & MARKER TO GREEN AUX.
TLED-4XAG



AMBER TURN & MARKER TO WHITE AUX.
TLED-4X40AW

TECHNICAL SPECIFICATIONS

DOT/SAE	DOT To Auxiliary
DIODES	19 Diodes
FUNCTION	Function 1: Turn & Marker Function 2: Auxiliary
CURRENT DRAW	Function 1: 270 mA Function 2: 247 mA
LENS MATERIAL	Polycarbonate
WARRANTY	3 Years

ACCESSORY OPTIONS

GROMMETS (pg. 115)	TGRO-4R, TGRO-4RC
WIRE HARNESS (pg.116-118)	B612, S Series, TPIG-3W
BEZELS (pg. 113-114)	TBEZ-4LR, TBEZ-4CH2, TBEZ-4CH3, TBEZ-4CH4, TBEZ-4CH5



CASE QTY.
100 PCS

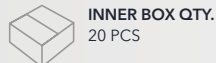

INNER BOX QTY.
20 PCS

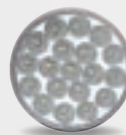

OFF

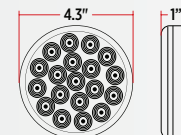

WIRING

3 PRONG & BULLET PLUG

TURN &
MARKER
AUX.

*Assemble with any standard
3 Prong Pigtail and Single
Female Wire Harness.*

WARNING: Cancer and Reproductive Harm - www.p65warnings.ca.gov

4" ROUND - 19 LEDS FLANGE MOUNT - S, T & T TO AUXILIARY



▲ RED S, T & T TO BLUE AUX.
TLED-4XRBF

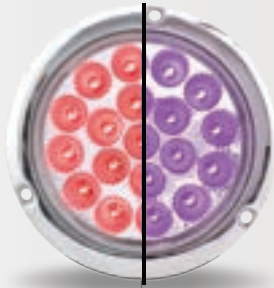

▲ RED S, T & T TO PURPLE AUX.
TLED-4XRPF



▲ RED S, T & T TO GREEN AUX.
TLED-4XRGF

TECHNICAL SPECIFICATIONS

DOT/SAE	DOT To Auxiliary
DIODES	19 Diodes
FUNCTION	Function 1: Stop, Turn & Tail Function 2: Auxiliary
CURRENT DRAW	Function 1: 270 mA~280 mA Function 2: 211 mA~247 mA
LENS MATERIAL	Polycarbonate
WARRANTY	3 Years

ACCESSORY OPTIONS

WIRE HARNESS (pg. 116-118) B612, S Series, TPIG-3W



CASE QTY.
50 PCS



INNER BOX QTY.
10 PCS

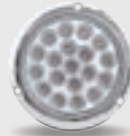

OFF

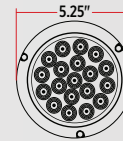

WIRING

3 PRONG & BULLET PLUG



S, T & T

AUX.

Assemble with any standard 3 Prong Pigtail and Single Female Wire Harness.



DUAL REVOLUTION LED

6" OVAL - 12 LEDS GROMMET MOUNT - TURN & MARKER TO AUXILIARY

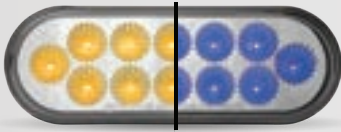

AMBER TURN & MARKER TO BLUE AUX.
TLED-OXAB

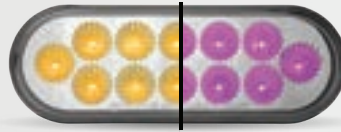

AMBER TURN & MARKER TO PURPLE AUX.
TLED-OXAP

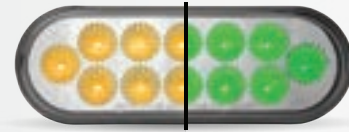

AMBER TURN & MARKER TO GREEN AUX.
TLED-OXAG

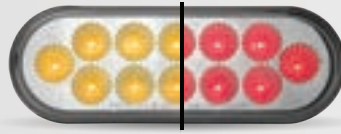

AMBER TURN & MARKER TO RED AUX.
TLED-OXAR

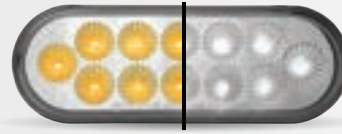

AMBER TURN & MARKER TO WHITE AUX.
TLED-OX60A

TECHNICAL SPECIFICATIONS

DOT/SAE	DOT To Auxiliary
DIODES	12 Diodes
FUNCTION	Function 1: Turn & Marker Function 2: Auxiliary
CURRENT DRAW	Function 1: 145 mA~152 mA Function 2: 123 mA~130 mA
LENS MATERIAL	Polycarbonate
WARRANTY	3 Years

ACCESSORY OPTIONS

GROMMETS (pg. 115)	TGRO-OBR, TGRO-OBRC
WIRE HARNESS (pg. 116-118)	B612, S Series, TPIG-3W
BEZELS (pg. 114)	TBEZ-OLR, TBEZ-OBCH2, TBEZ-OBCH3, TBEZ-OBCH4



OFF

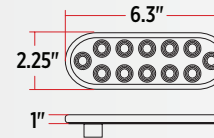

WIRING

3 PRONG & BULLET PLUG



TURN & MARKER

AUX.

Assemble with any standard 3 Prong Pigtail and Single Female Wire Harness.

6" OVAL - 12 LEDS GROMMET MOUNT - S, T & T TO AUXILIARY

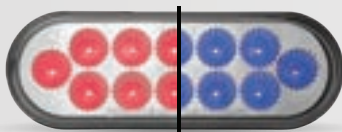

RED S, T & T TO BLUE AUX.
TLED-OXR

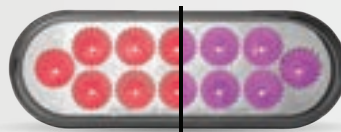

RED S, T & T TO PURPLE AUX.
TLED-OXRP

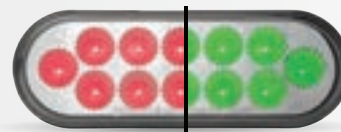

RED S, T & T TO GREEN AUX.
TLED-OXRG

TECHNICAL SPECIFICATIONS

DOT/SAE	DOT To Auxiliary
DIODES	12 Diodes
FUNCTION	Function 1: Stop, Turn & Tail Function 2: Auxiliary
CURRENT DRAW	Function 1: 145 mA~152 mA Function 2: 123~131 mA
LENS MATERIAL	Polycarbonate
WARRANTY	3 Years

ACCESSORY OPTIONS

GROMMETS (pg. 115)	TGRO-OBR, TGRO-OBRC
WIRE HARNESS (pg. 116-118)	B612, S Series, TPIG-3W
BEZELS (pg. 114)	TBEZ-OLR, TBEZ-OBCH2, TBEZ-OBCH3, TBEZ-OBCH4



OFF

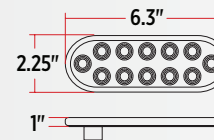

WIRING

3 PRONG & BULLET PLUG



S, T & T

AUX.

Assemble with any standard 3 Prong Pigtail and Single Female Wire Harness.

WARNING: Cancer and Reproductive Harm - www.p65warnings.ca.gov

**TOP
SELLER**

3/4" ROUND - 2 LEDS GROMMET & BEZEL - MARKER TO AUXILIARY



▲ AMBER MARKER TO BLUE AUX.
TLED-BX3AB



▲ AMBER MARKER TO PURPLE AUX.
TLED-BX3AP



▲ AMBER MARKER TO GREEN AUX.
TLED-BX3AG



▲ AMBER MARKER TO RED AUX.
TLED-BX3AR



▲ AMBER MARKER TO WHITE AUX.
TLED-BX3AW



▲ RED MARKER TO WHITE AUX.
TLED-BX3RW



▲ RED MARKER TO BLUE AUX.
TLED-BX3RB



▲ RED MARKER TO PURPLE AUX.
TLED-BX3RP



▲ RED MARKER TO GREEN AUX.
TLED-BX3RG

TECHNICAL SPECIFICATIONS

DOT/SAE	DOT To Auxiliary
DIODES	2 Diodes
FUNCTION	Function 1: Marker Function 2: Auxiliary
CURRENT DRAW	Function 1: 30 mA Function 2: 28 mA
LENS MATERIAL	Polycarbonate
WARRANTY	3 Years

ACCESSORY OPTIONS

WIRE HARNESS (pg. 117-118) T Series



CASE QTY.
100 PCS



INNER BOX QTY.
20 PCS



OFF

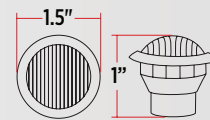

WIRING

3 BULLET PLUGS



Assemble with any Triple Female Wire Harness.

DUAL REVOLUTION LED

NEW

3/4" ROUND - 1 LED

GROMMET, TWIST ON NUT & BEZEL - MARKER TO AUXILIARY



▲ AMBER MARKER TO BLUE AUX.
TLED-BX1AB



▲ AMBER MARKER TO PURPLE AUX.
TLED-BX1AP



▲ AMBER MARKER TO GREEN AUX.
TLED-BX1AG



▲ AMBER MARKER TO RED AUX.
TLED-BX1AR



▲ AMBER MARKER TO WHITE AUX.
TLED-BX1AW



▲ RED MARKER TO WHITE AUX.
TLED-BX1RW



▲ RED MARKER TO BLUE AUX.
TLED-BX1RB



▲ RED MARKER TO PURPLE AUX.
TLED-BX1RP



▲ RED MARKER TO GREEN AUX.
TLED-BX1RG

TECHNICAL SPECIFICATIONS

DOT/SAE	DOT To Auxiliary
DIODES	1 Diode
FUNCTION	Function 1: Marker Function 2: Auxiliary
CURRENT DRAW	Function 1: 30 mA Function 2: 30 mA
LENS MATERIAL	Polycarbonate
WARRANTY	3 Years

ACCESSORY OPTIONS

WIRE HARNESS (pg. 117-118) T Series



CASE QTY.
100 PCS



INNER BOX QTY.
20 PCS



OFF

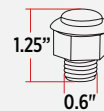

1.25"

0.6"

GROMMET

THREAD

NUT & THREAD
INSTALLATION



TWO
GASKETS

NUT

THREAD

2-IN-1 INSTALLATION

New and Improved 3/4" Round LEDs come with Two Installation Options:

GROMMET INSTALLATION



NUT & THREAD
INSTALLATION



WIRING

3 BULLET PLUGS



Assemble with any Triple Female Wire Harness.



⚠ WARNING: Cancer and Reproductive Harm - www.p65warnings.ca.gov

3/4" OVAL - 2 LEDS GROMMET & BEZEL - MARKER TO AUXILIARY

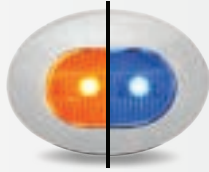

▲ AMBER MARKER TO BLUE AUX.
TLED-BX4AB

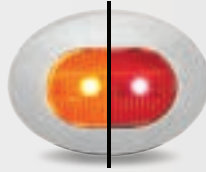

▲ AMBER MARKER TO RED AUX.
TLED-BX4AR

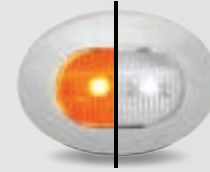

▲ AMBER MARKER TO WHITE AUX.
TLED-BX4AW

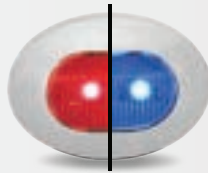

▲ RED MARKER TO BLUE AUX.
TLED-BX4RB

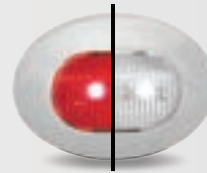

▲ RED MARKER TO WHITE AUX.
TLED-BX4RW

TECHNICAL SPECIFICATIONS

DOT/SAE	DOT To Auxiliary
DIODES	2 Diodes
FUNCTION	Function 1: Marker Function 2: Auxiliary
CURRENT DRAW	Function 1: 30 mA Function 2: 28 mA
LENS MATERIAL	Polycarbonate
WARRANTY	3 Years

ACCESSORY OPTIONS

WIRE HARNESS (pg. 117-118)	T Series
----------------------------	----------



CASE QTY.
100 PCS



INNER BOX QTY.
20 PCS



OFF

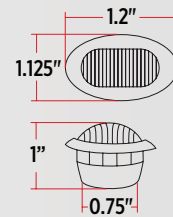

WIRING

3 BULLET PLUGS



Assemble with any Triple Female Wire Harness.



DUAL REVOLUTION LED

2" ROUND - 7 LEDs GROMMET MOUNT - MARKER TO AUXILIARY

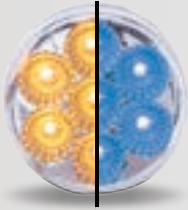

▲ AMBER MARKER TO BLUE AUX.
TLED-2XAB

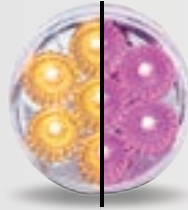

▲ AMBER MARKER TO PURPLE AUX.
TLED-2XAP

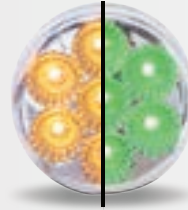

▲ AMBER MARKER TO GREEN AUX.
TLED-2XAG

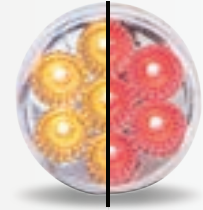

▲ AMBER MARKER TO RED AUX.
TLED-2XAR

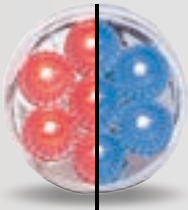

▲ RED MARKER TO BLUE AUX.
TLED-2XRB

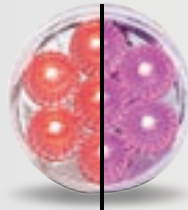

▲ RED MARKER TO PURPLE AUX.
TLED-2XRP



▲ RED MARKER TO GREEN AUX.
TLED-2XRG

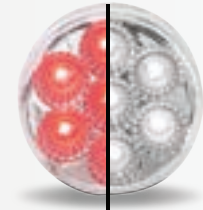

▲ RED MARKER TO WHITE AUX.
TLED-2XRW

TECHNICAL SPECIFICATIONS

DOT/SAE	DOT To Auxiliary
DIODES	7 Diodes
FUNCTION	Function 1: Marker Function 2: Auxiliary
CURRENT DRAW	Function 1: 67 mA Function 2: 63 mA
LENS MATERIAL	Polycarbonate
WARRANTY	3 Years

ACCESSORY OPTIONS

GROMMETS (pg. 115)	TGRO-2R, TGRO-2RC
WIRE HARNESS (pg. 116-118)	B Series, S Series, TPIG-2W
BEZELS (pg. 113)	TBEZ-2CH2, TBEZ-2CH3, TBEZ-2CH4, TBEZ-2CH5



CASE QTY.
100 PCS



INNER BOX QTY.
20 PCS



OFF

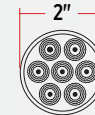

2"



1"

WIRING

2 PRONG & BULET PLUG



Assemble with any standard 2 Prong Pigtail and Single Female Wire Harness.



⚠ WARNING: Cancer and Reproductive Harm - www.p65warnings.ca.gov

2.5" ROUND - 7 LEDS GROMMET MOUNT - MARKER TO AUXILIARY

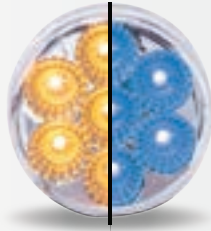

▲ AMBER MARKER TO BLUE AUX.
TLED-2HXAB

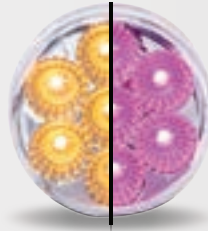

▲ AMBER MARKER TO PURPLE AUX.
TLED-2HXAP

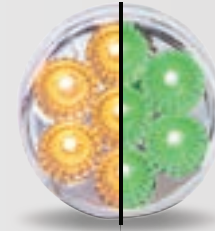

▲ AMBER MARKER TO GREEN AUX.
TLED-2HXAG

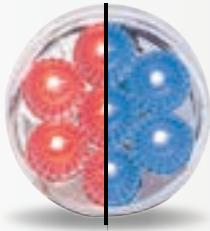

▲ RED MARKER TO BLUE AUX.
TLED-2HXR B

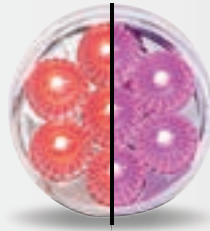

▲ RED MARKER TO PURPLE AUX.
TLED-2HXR P

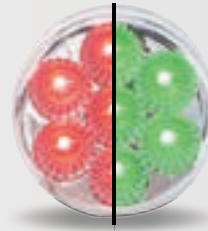

▲ RED MARKER TO GREEN AUX.
TLED-2HXR G

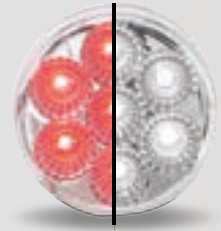

▲ RED MARKER TO WHITE AUX.
TLED-2HXR W

TECHNICAL SPECIFICATIONS

DOT/SAE	DOT To Auxiliary
DIODES	7 Diodes
FUNCTION	Function 1: Marker Function 2: Auxiliary
CURRENT DRAW	Function 1: 110 mA Function 2: 85 mA ~ 90 mA
LENS MATERIAL	Polycarbonate
WARRANTY	3 Years

ACCESSORY OPTIONS

GROMMETS (pg. 115)	TGRO-2HR, TGRO-2HRO
WIRE HARNESS (pg. 116-118)	B Series, S Series, TPIG-2W
BEZELS (pg. 113)	TBEZ-2HCH2, TBEZ-2HCH3, TBEZ-2HCH4, TBEZ-2HCH5



CASE QTY.
200 PCS

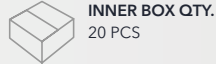

INNER BOX QTY.
20 PCS



OFF



2.5"



1"

WIRING

2 PRONG & BULLET PLUG



MARKER



AUX.

Assemble with any standard
2 Prong Pigtail and Single
Female Wire Harness.



⚠ WARNING: Cancer and Reproductive Harm - www.p65warnings.ca.gov

DUAL REVOLUTION LED

**TOP
SELLER**

GENERATION 4 - 10 LEDS MARKER TO AUXILIARY



▲ AMBER MARKER TO BLUE AUX.
TLED-G4XAB

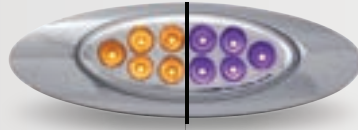

▲ AMBER MARKER TO PURPLE AUX.
TLED-G4XAP

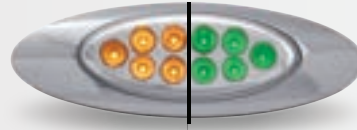

▲ AMBER MARKER TO GREEN AUX.
TLED-G4XAG



▲ AMBER MARKER TO WHITE AUX.
TLED-G4XAW

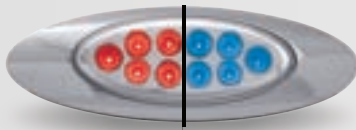

▲ RED MARKER TO BLUE AUX.
TLED-G4XRB

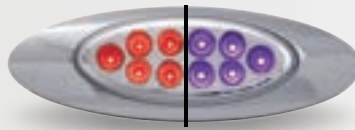

▲ RED MARKER TO PURPLE AUX.
TLED-G4XRP

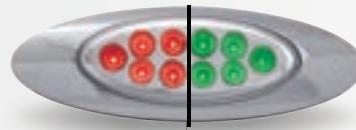

▲ RED MARKER TO GREEN AUX.
TLED-G4XRG

TECHNICAL SPECIFICATIONS

DOT/SAE	DOT To Auxiliary
DIODES	10 Diodes
FUNCTION	Function 1: Marker Function 2: Auxiliary
CURRENT DRAW	Function 1: 120 mA Function 2: 100 mA
LENS MATERIAL	Polycarbonate
WARRANTY	3 Years

ACCESSORY OPTIONS

WIRE HARNESS (pg. 118)	T Series
------------------------	----------



CASE QTY.
100 PCS



INNER BOX QTY.
10 PCS



OFF

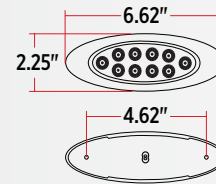

WIRING

3 BULLET PLUGS



Assemble with any Triple Female Wire Harness.



⚠ WARNING: Cancer and Reproductive Harm - www.p65warnings.ca.gov

GENERATION 2 - 4 LEDS MARKER TO AUXILIARY

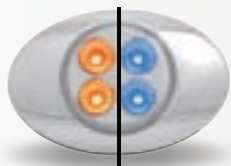

▲ AMBER MARKER TO BLUE AUX.
TLED-G2XAB

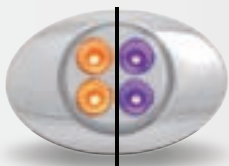

▲ AMBER MARKER TO PURPLE AUX.
TLED-G2XAP

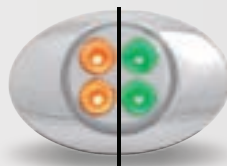

▲ AMBER MARKER TO GREEN AUX.
TLED-G2XAG

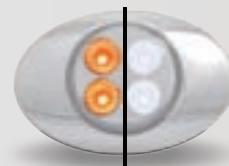

▲ AMBER MARKER TO WHITE AUX.
TLED-G2XAW

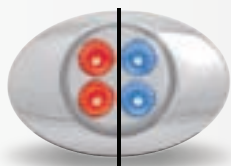

▲ RED MARKER TO BLUE AUX.
TLED-G2XRB

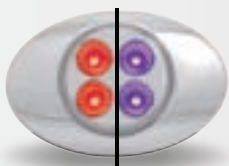

▲ RED MARKER TO PURPLE AUX.
TLED-G2XRP

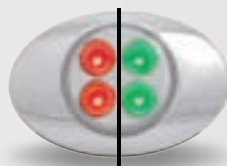

▲ RED MARKER TO GREEN AUX.
TLED-G2XRG

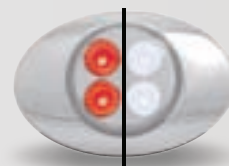

▲ RED MARKER TO WHITE AUX.
TLED-G2XRW

TECHNICAL SPECIFICATIONS

DOT/SAE	DOT To Auxiliary
DIODES	4 Diodes
FUNCTION	Function 1: Marker Function 2: Auxiliary
CURRENT DRAW	Function 1: 60 mA Function 2: 63 mA ~ 65 mA
LENS MATERIAL	Polycarbonate
WARRANTY	3 Years

ACCESSORY OPTIONS

WIRE HARNESS (pg. 118)	T Series
CASE QTY. 100 PCS	OFF
INNER BOX QTY. 20 PCS	

WIRING

3 BULLET PLUGS



Assemble with any Triple Female Wire Harness.

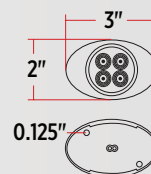

DUAL REVOLUTION LED

WATERMELON - 19 LEDS

S, T & T TO AUXILIARY | TURN & MARKER TO AUXILIARY



▲ AMBER TURN & MARKER TO **BLUE** AUX.
TLED-WXAB



▲ AMBER TURN & MARKER TO **PURPLE** AUX.
TLED-WXAP



▲ AMBER TURN & MARKER TO **GREEN** AUX.
TLED-WXAG



▲ AMBER TURN & MARKER TO **RED** AUX.
TLED-WXAR



▲ AMBER TURN & MARKER TO **WHITE** AUX.
TLED-WXAW



▲ RED S, T & T TO **WHITE** AUX.
TLED-WXRW



▲ RED S, T & T TO **BLUE** AUX.
TLED-WXRB



▲ RED S, T & T TO **PURPLE** AUX.
TLED-WXRP



▲ RED S, T & T TO **GREEN** AUX.
TLED-WXRG

TECHNICAL SPECIFICATIONS

DOT/SAE	DOT To Auxiliary
DIODES	19 Diodes
STOP, TURN & TAIL TO AUXILIARY	TLED-WXRB, TLED-WXRP, TLED-WXRG, TLED-WXRW
TURN & MARKER TO AUXILIARY	TLED-WXAB, TLED-WXAP, TLED-WXAG, TLED-WXAR, TLED-WXAW
CURRENT DRAW	Function 1: 240 mA Function 2: 240 mA
LENS MATERIAL	Polycarbonate
WARRANTY	3 Years

ACCESSORY OPTIONS

WIRE HARNESS (pg. 117-118) T Series, S Series

CASE QTY.
50 PCS

INNER BOX QTY.
10 PCS



OFF



WIRING

4 BULLET PLUGS



Assemble with any Triple Female Wire Harness and Single Female Wire Harness.

▲ WARNING: Cancer and Reproductive Harm - www.p65warnings.ca.gov

PETERBILT CAB - 19 LEDS MARKER TO AUXILIARY



▲ AMBER MARKER TO BLUE AUX.
TLED-PCAB2XAB



▲ AMBER MARKER TO PURPLE AUX.
TLED-PCAB2XAP



▲ AMBER MARKER TO GREEN AUX.
TLED-PCAB2XAG

TECHNICAL SPECIFICATIONS

DOT/SAE	DOT To Auxiliary
DIODES	19 Diodes
FUNCTION	Function 1: Marker Function 2: Auxiliary
CURRENT DRAW	Function 1: 270 mA Function 2: 247 mA
LENS MATERIAL	Polycarbonate
WARRANTY	3 Years



CASE QTY.
20 PCS



INNER BOX QTY.
5 PCS

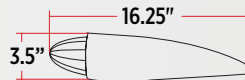

OFF

WIRING

3 WIRES



SQUARE CAB -42 LEDS MARKER TO AUXILIARY



▲ AMBER MARKER TO BLUE AUX.
TLED-CAB2XAB



▲ AMBER MARKER TO PURPLE AUX.
TLED-CAB2XAP



▲ AMBER MARKER TO GREEN AUX.
TLED-CAB2XAG

TECHNICAL SPECIFICATIONS

DOT/SAE	DOT To Auxiliary
DIODES	42 Diodes
FUNCTION	Function 1: Marker Function 2: Auxiliary
CURRENT DRAW	Function 1: 470 mA Function 2: 465 mA
LENS MATERIAL	Polycarbonate
WARRANTY	3 Years



CASE QTY.
20 PCS



INNER BOX QTY.
5 PCS

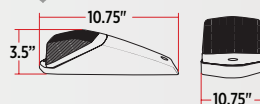

OFF

WIRING

3 WIRES



DUAL REVOLUTION LED

PETERBILT SIDE HEADLIGHT - 24 LEDS TURN & MARKER TO AUXILIARY

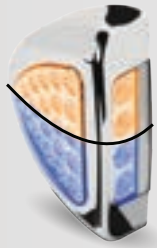

AMBER TURN & MARKER TO **BLUE** AUX.
TLED-PSHXB

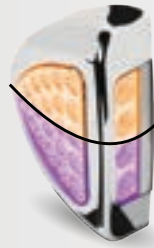

AMBER TURN & MARKER TO **PURPLE** AUX.
TLED-PSHXP



AMBER TURN & MARKER TO **GREEN** AUX.
TLED-PSHXG

TECHNICAL SPECIFICATIONS

DOT/SAE	DOT To Auxiliary
DIODES	24 Diodes
FUNCTION	Function 1: Turn & Marker Function 2: Auxiliary
CURRENT DRAW	Function 1: 310 mA Function 2: 260 mA
LENS MATERIAL	Polycarbonate
WARRANTY	3 Years



CASE QTY.
100 PCS



INNER BOX QTY.
10 PCS



OFF

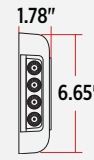

WIRING

4 WIRES



HEADLIGHT BEZEL - 55 LEDS MARKER TO AUXILIARY



AMBER MARKER TO **BLUE** AUX.
TLED-FX106

TECHNICAL SPECIFICATIONS

DOT/SAE	DOT To Auxiliary
DIODES	55 Diodes
FUNCTION	Function 1: Marker Function 2: Auxiliary
CURRENT DRAW	Function 1: 550 mA Function 2: 500 mA
LENS MATERIAL	Polycarbonate
WARRANTY	3 Years



CASE QTY.
20 PCS



INNER BOX QTY.
4 PCS

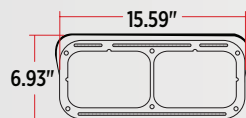
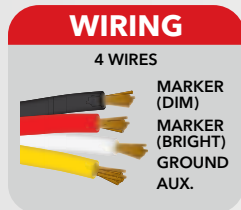

OFF

RECTANGULAR - 10 LEDS MARKER TO AUXILIARY



AMBER MARKER TO **BLUE** AUX.
TLED-2X6AB

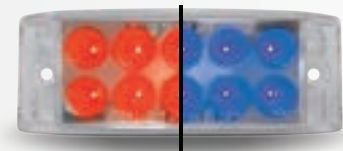

RED MARKER TO **BLUE** AUX.
TLED-2X6RB

TECHNICAL SPECIFICATIONS

DOT/SAE	DOT To Auxiliary
DIODES	10 Diodes
FUNCTION	Function 1: Marker Function 2: Auxiliary
CURRENT DRAW	Function 1: 108 mA Function 2: 110 mA
LENS MATERIAL	Polycarbonate
WARRANTY	3 Years

ACCESSORY OPTIONS

WIRE HARNESS T Series (pg. 117-118)



CASE QTY.
100 PCS



INNER BOX QTY.
20 PCS

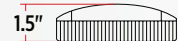
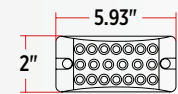
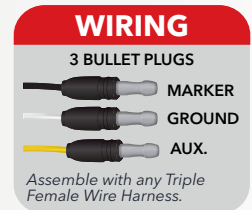

OFF

WARNING: Cancer and Reproductive Harm - www.p65warnings.ca.gov

0.5" X 17" UNDERMOUNT - 24 LEDS MARKER TO AUXILIARY

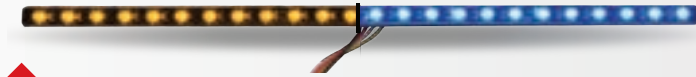

▲ AMBER MARKER TO BLUE AUX.
TLED-SXAB



▲ RED MARKER TO BLUE AUX.
TLED-SXRB

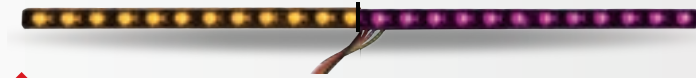

▲ AMBER MARKER TO PURPLE AUX.
TLED-SXAP

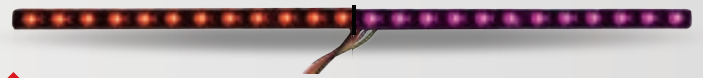

▲ RED MARKER TO PURPLE AUX.
TLED-SXRP

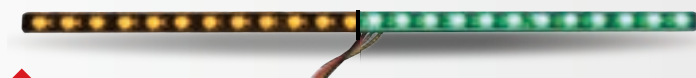

▲ AMBER MARKER TO GREEN AUX.
TLED-SXAG



▲ RED MARKER TO GREEN AUX.
TLED-SXRG

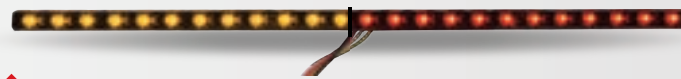

▲ AMBER MARKER TO RED AUX.
TLED-SXAR

TECHNICAL SPECIFICATIONS

DOT/SAE	DOT To Auxiliary
DIODES	24 Diodes
FUNCTION	Function 1: Marker Function 2: Auxiliary
CURRENT DRAW	Function 1: 200 mA Function 2: 210 mA
LENS MATERIAL	Polycarbonate
WARRANTY	3 Years

ACCESSORY OPTIONS

WIRE HARNESS (pg. 118)	T Series
------------------------	----------

CASE QTY. 50 PCS
 INNER BOX QTY. 10 PCS

OFF

WIRING

3 BULLET PLUGS



Assemble with any Triple Female Wire Harness.



▲ WARNING: Cancer and Reproductive Harm - www.p65warnings.ca.gov

DUAL REVOLUTION LED

NEW

ROUND DOUBLE FACE - 38 LEDS TURN & MARKER TO AUXILIARY

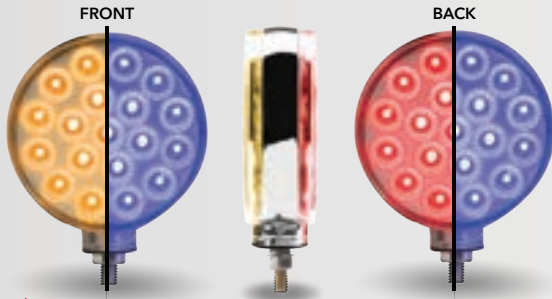

AMBER/RED TURN & MARKER TO **BLUE** AUX.
TLED-DFXB

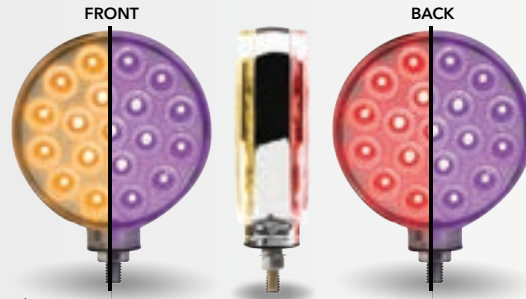

AMBER/RED TURN & MARKER TO **PURPLE** AUX.
TLED-DFXP

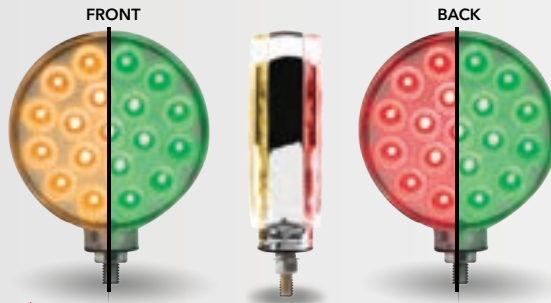

AMBER/RED TURN & MARKER TO **GREEN** AUX.
TLED-DFXG

TECHNICAL SPECIFICATIONS

DOT/SAE	DOT To Auxiliary
DIODES	38 Diodes
FUNCTION	Function 1: Turn & Marker Function 2: Auxiliary
CURRENT DRAW	Function 1: 180 mA Function 2: 175 mA
LENS MATERIAL	Polycarbonate
WARRANTY	3 Years



CASE QTY.
50 PCS



INNER BOX QTY.
10 PCS



OFF



WIRING

4 WIRES



WARNING: Cancer and Reproductive Harm - www.p65warnings.ca.gov

NEW

SQUARE DOUBLE FACE - 38 LEDS TURN & MARKER TO AUXILIARY



AMBER/RED TURN & MARKER TO BLUE AUX.
TLED-SDXB



AMBER/RED TURN & MARKER TO PURPLE AUX.
TLED-SDXP



AMBER/RED TURN & MARKER TO GREEN AUX.
TLED-SDXG

TECHNICAL SPECIFICATIONS

DOT/SAE	DOT To Auxiliary
DIODES	38 Diodes
FUNCTION	Function 1: Turn & Marker Function 2: Auxiliary
CURRENT DRAW	Function 1: 180 mA Function 2: 175 mA
LENS MATERIAL	Polycarbonate
WARRANTY	3 Years



CASE QTY.
50 PCS



INNER BOX QTY.
10 PCS



OFF

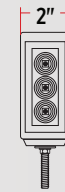
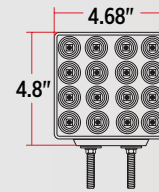

WIRING

4 WIRES

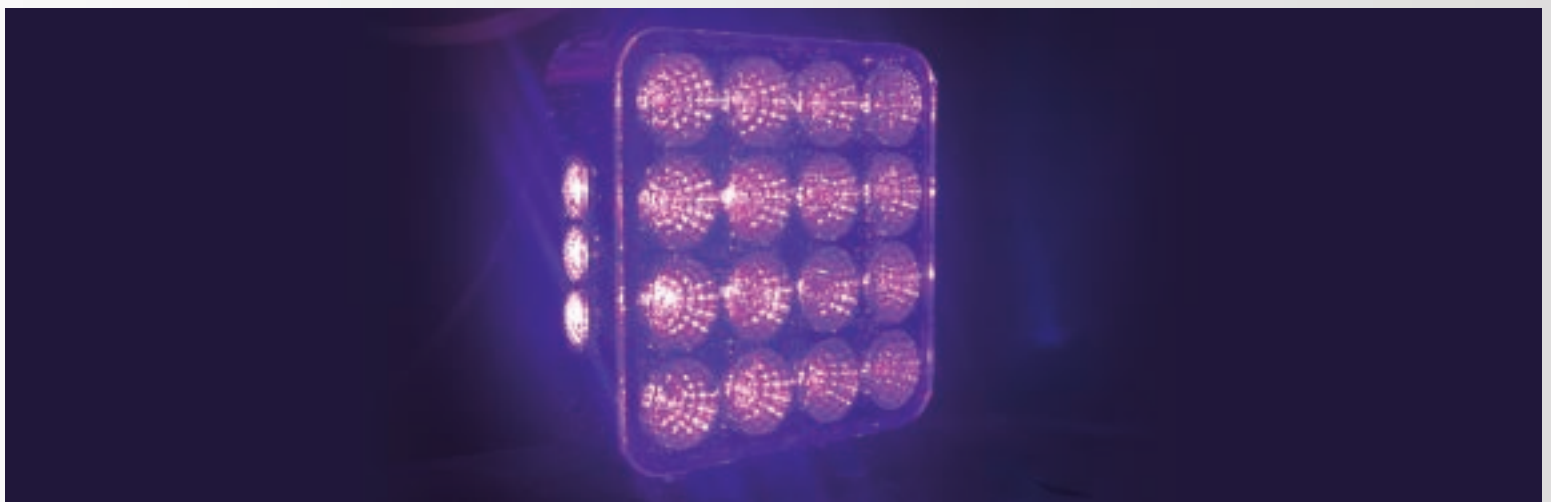

WARNING: Cancer and Reproductive Harm - www.p65warnings.ca.gov

LED LIGHTING



4" ROUND - 8 LEDS GROMMET MOUNT - S, T & T

**TOP
SELLER**



RED S, T & T
TLED-48R



CLEAR RED S, T & T
TLED-48CR



AMBER TURN & MARKER
TLED-48A



RED S, T & T WITH SUPER SEAL ADAPTER
TLED-48RT

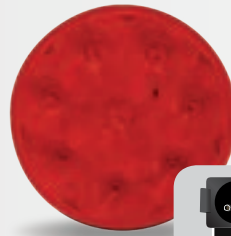

RED S, T & T WITH LOCK ADAPTER
TLED-48RG

TECHNICAL SPECIFICATIONS

DOT/SAE	Compliant
DIODES	8 Diodes
STOP, TURN & TAIL	TLED-48R, TLED-48CR, TLED-48RT, TLED-48RG
TURN & MARKER	TLED-48A
CURRENT DRAW	130 mA
LENS MATERIAL	Polycarbonate
WARRANTY	3 Years

ACCESSORY OPTIONS

GROMMETS (pg. 115)	TGRO-4R, TGRO-4RC
WIRE HARNESS (pg.117-118)	B612, TPIG-3W
BEZELS (pg. 113-114)	TBEZ-4LR, TBEZ-4CH2, TBEZ-4CH3, TBEZ-4CH4, TBEZ-4CH5



CASE QTY.
100 PCS



INNER BOX QTY.
20 PCS

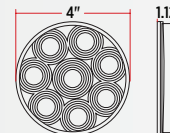

WIRING

3 PRONG ADAPTER



Assemble with any standard 3 Prong Male Wire Harness.

WARNING: Cancer and Reproductive Harm - www.p65warnings.ca.gov

**TRUX'S
TOP SELLING
POS DISPLAY**



4" STOP, TURN & TAIL POS DISPLAY

TRX-136 CONTAINS



48 X TLED-48R1

RED STOP, TURN & TAIL

8 DIODES

3 YEAR WARRANTY

18" x 12" x 9"

SEE PAGE 313 FOR MORE INFORMATION

 **WARNING:** Cancer and Reproductive Harm - www.p65warnings.ca.gov

LED LIGHTING

4" ROUND - 19 LEDS GROMMET MOUNT - S, T & T



RED S, T & T
TLED-419R

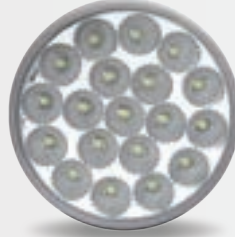

CLEAR RED S, T & T
TLED-419CR

TECHNICAL SPECIFICATIONS

DOT/SAE	Compliant
DIODES	19 Diodes
STOP, TURN & TAIL	TLED-419CR, TLED-419R
CURRENT DRAW	120 mA
LENS MATERIAL	Polycarbonate
WARRANTY	3 Years

ACCESSORY OPTIONS

GROMMETS (pg. 115)	TGRO-4R, TGRO-4RC
WIRE HARNESS (pg.117-118)	B612, TPIG-3W
BEZELS (pg. 113-114)	TBEZ-4LR, TBEZ-4CH2, TBEZ-4CH3, TBEZ-4CH4, TBEZ-4CH5

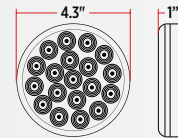
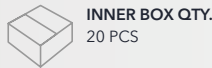

WIRING

3 PRONG ADAPTER



Assemble with any standard 3 Prong Male Wire Harness.

4" ROUND - 19 LEDS GROMMET MOUNT - S, T & T | TURN & MARKER | BACK UP

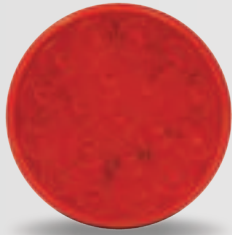

RED S, T & T
TLED-4100R



AMBER TURN & MARKER
TLED-4100A



WHITE BACK UP
TLED-4100W

TECHNICAL SPECIFICATIONS

DOT/SAE	Compliant
DIODES	19 Diodes
STOP, TURN & TAIL	TLED-4100R
TURN & MARKER	TLED-4100A
BACK UP	TLED-4100W
CURRENT DRAW	105 mA ~ 140 mA
LENS MATERIAL	Polycarbonate
WARRANTY	3 Years

ACCESSORY OPTIONS

GROMMETS (pg. 115)	TGRO-4R, TGRO-4RC
WIRE HARNESS (pg.117-118)	B612, TPIG-3W
BEZELS (pg. 113-114)	TBEZ-4LR, TBEZ-4CH2, TBEZ-4CH3, TBEZ-4CH4, TBEZ-4CH5

TLED-4100R, TLED-4100A:



TLED-4100W:

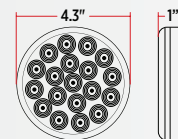
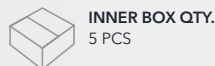

WIRING

3 PRONG ADAPTER



Assemble with any standard 3 Prong Male Wire Harness.

WARNING: Cancer and Reproductive Harm - www.p65warnings.ca.gov

4" ROUND - 19 LEDS FLANGE MOUNT - S, T & T

NEW



RED LENS S, T & T
TLED-419RF

CLEAR RED S, T & T
TLED-419CRF

TECHNICAL SPECIFICATIONS

DOT/SAE	Compliant
DIODES	19 Diodes
STOP, TURN & TAIL	TLED-419CRF, TLED-419RF
CURRENT DRAW	120 mA
LENS MATERIAL	Polycarbonate
WARRANTY	3 Years

ACCESSORY OPTIONS

WIRE HARNESS	B612, TPIG-3W (pg. 116-118)
--------------	-----------------------------

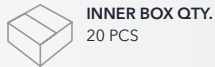

WIRING
3 PRONG ADAPTER

Assemble with any standard 3 Prong Male Wire Harness.

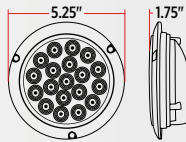

4" ROUND - 30+ LEDS GROMMET MOUNT - S, T & T



RED S, T & T
TLED-430R

TECHNICAL SPECIFICATIONS

DOT/SAE	Compliant
DIODES	30 Diodes
STOP, TURN & TAIL	TLED-430R
CURRENT DRAW	240 mA ~ 250 mA
LENS MATERIAL	Polycarbonate
WARRANTY	3 Years

ACCESSORY OPTIONS

GROMMETS	TGRO-4R, TGRO-4RC (pg.115)
WIRE HARNESS	B612, TPIG-3W (pg.117-118)
BEZELS	TBEZ-4LR, TBEZ-4CH2, TBEZ-4CH3, TBEZ-4CH4, TBEZ-4CH5 (p.113-114)

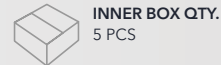

WIRING
3 PRONG ADAPTER

Assemble with any standard 3 Prong Male Wire Harness.

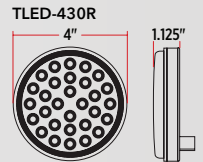

LED LIGHTING

4" ROUND FLATLINE - 49 LEDS GROMMET MOUNT - S, T & T

[PATENTED DESIGN]



RED S, T & T
TLED-F4R



CLEAR RED S, T & T
TLED-F4CR

TECHNICAL SPECIFICATIONS

DIODES	49 Diodes
STOP, TURN & TAIL	TLED-F4R, TLED-F4CR
CURRENT DRAW	138 mA
LENS MATERIAL	Polycarbonate
WARRANTY	3 Years

ACCESSORY OPTIONS

GROMMETS	TGRO-4R, TGRO-4RC (pg. 115)
WIRE HARNESS	B612, TPIG-3W (pg. 117-118)
BEZELS	TBEZ-4LR, TBEZ-4CH2, TBEZ-4CH3, TBEZ-4CH4, TBEZ-4CH5 (pg. 113-114)



WIRING

3 PRONG ADAPTER



Assemble with any standard 3 Prong Male Wire Harness.

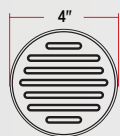

4" ROUND FLATLINE - 49 LEDS FLANGE MOUNT - S, T & T

[PATENTED DESIGN]



RED S, T & T
TLED-F4R1



CLEAR RED S, T & T
TLED-F4CR1

TECHNICAL SPECIFICATIONS

DIODES	49 Diodes
STOP, TURN & TAIL	TLED-F4R1, TLED-F4CR1
CURRENT DRAW	138 mA
LENS MATERIAL	Polycarbonate
WARRANTY	3 Years

ACCESSORY OPTIONS

WIRE HARNESS	B612, TPIG-3W (pg. 117-118)
--------------	-----------------------------

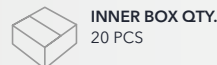

WIRING

3 PRONG ADAPTER



Assemble with any standard 3 Prong Male Wire Harness.



6" OVAL - 12 LEDS GROMMET MOUNT - S, T & T | TURN & MARKER

NEW



AMBER TURN & MARKER
TLED-O12A



CLEAR AMBER TURN & MARKER
TLED-O12CA

NEW

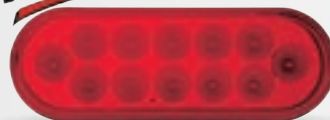

RED S, T & T
TLED-O12R



CLEAR RED S, T & T
TLED-O12CR

TECHNICAL SPECIFICATIONS

DOT/SAE	Compliant
DIODES	12 Diodes
STOP, TURN & TAIL	TLED-O12CR, TLED-O12R
TURN & MARKER	TLED-O12CA, TLED-O12A
CURRENT DRAW	147 mA
LENS MATERIAL	Polycarbonate
WARRANTY	3 Years

ACCESSORY OPTIONS

GROMMETS (pg. 115)	TGRO-OBR, TGRO-OBRC
WIRE HARNESS (pg. 117-118)	B612, TPIG-3W
BEZELS (pg. 114)	TBEZ-OBCH2, TBEZ-OBCH3, TBEZ-OBCH4, TBEZ-OBCH5, TBEZ-OLR

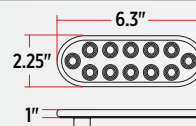
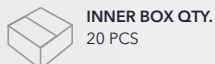

WIRING

3 PRONG ADAPTER



Assemble with any standard 3 Prong Male Wire Harness.

⚠ WARNING: Cancer and Reproductive Harm - www.p65warnings.ca.gov

6" OVAL - 13 LEDS

GROMMET MOUNT - S,T & T | TURN & MARKER | BACK UP



AMBER TURN & MARKER
TLED-OBMA



CLEAR AMBER TURN & MARKER
TLED-OBMCA



RED S, T & T
TLED-OBMR



CLEAR RED S, T & T
TLED-OBMCR



WHITE BACK UP
TLED-OBMW

TECHNICAL SPECIFICATIONS

DOT/SAE	Compliant
DIODES	13 Diodes
STOP, TURN & TAIL	TLED-OBMR, TLED-OBMCR
TURN & MARKER	TLED-OBMA, TLED-OBMCA
BACK UP	TLED-OBMW
CURRENT DRAW	70 mA ~ 110 mA
LENS MATERIAL	Polycarbonate
WARRANTY	3 Years

ACCESSORY OPTIONS

GROMMETS (pg. 115)	TGRO-OBR, TGRO-OBRC
WIRE HARNESS (pg. 117-118)	B612, TPIG-3W
BEZELS (pg. 114)	TBEZ-OBCH2, TBEZ-OBCH3, TBEZ-OBCH4, TBEZ-OBCH5, TBEZ-OLR



CASE QTY.
100 PCS



INNER BOX QTY.
20 PCS

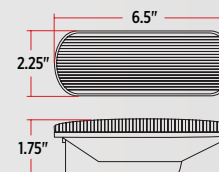

WIRING

3 PRONG ADAPTER



Assemble with any standard
3 Prong Male Wire Harness.

3/4" OVAL - 2 LEDS

GROMMET & BEZEL - MARKER - 3 WIRES



AMBER MARKER
TLED-B4A



CLEAR AMBER MARKER
TLED-B4CA



RED MARKER
TLED-B4R



CLEAR RED MARKER
TLED-B4CR

TECHNICAL SPECIFICATIONS

DOT/SAE	Compliant
DIODES	2 Diodes
MARKER	TLED-B4A, TLED-B4CA, TLED-B4R, TLED-B4CR
CURRENT DRAW	34.2 mA
LENS MATERIAL	Polycarbonate
WARRANTY	3 Years

ACCESSORY OPTIONS

WIRE HARNESS (pg. 117-118)	T Series
----------------------------	----------



CASE QTY.
100 PCS



INNER BOX QTY.
20 PCS

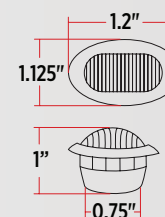

WIRING

3 BULLET PLUGS



Assemble with any Triple
Female Wire Harness.

LED LIGHTING

**TOP
SELLER**

3/4" ROUND - 3 LEDS GROMMET & BEZEL - MARKER - 2 WIRES



▲ **AMBER MARKER
TLED-B2A**



▲ **CLEAR AMBER MARKER
TLED-B2CA**



▲ **RED MARKER
TLED-B2R**



▲ **CLEAR RED MARKER
TLED-B2CR**



▲ **AMBER MARKER
TLED-B5A** Grommet Only



▲ **CLEAR AMBER MARKER
TLED-B5CA** Grommet Only



▲ **RED MARKER
TLED-B5R** Grommet Only



▲ **CLEAR RED MARKER
TLED-B5CR** Grommet Only

TECHNICAL SPECIFICATIONS

DIODES	3 Diodes
MARKER	TLED-B2A, TLED-B2CA, TLED-B2R, TLED-B2CR, TLED-B5A, TLED-B5CA, TLED-B5R, TLED-B5CR
CURRENT DRAW	40 mA
LENS MATERIAL	Polycarbonate
WARRANTY	3 Years

ACCESSORY OPTIONS

WIRE HARNESS (pg. 117-118)	D Series
CASE QTY. 100 PCS	INNER BOX QTY. 20 PCS
1.5"	1"

GROMMET & BEZEL

WIRING

2 BULLET PLUGS

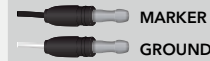

Assemble with any Double Female Wire Harness.

GROMMET

WIRING

2 WIRES



3/4" ROUND - 3 LEDS GROMMET & BEZEL - MARKER - 3 WIRES



▲ **AMBER MARKER
TLED-B3A**



▲ **CLEAR AMBER MARKER
TLED-B3CA**



▲ **RED MARKER
TLED-B3R**



▲ **CLEAR RED MARKER
TLED-B3CR**

TECHNICAL SPECIFICATIONS

DIODES	3 Diodes
MARKER	TLED-B3A, TLED-B3CA, TLED-B3R, TLED-B3CR
CURRENT DRAW	40 mA
LENS MATERIAL	Polycarbonate
WARRANTY	3 Years

ACCESSORY OPTIONS

WIRE HARNESS (pg. 117-118)	T Series
CASE QTY. 100 PCS	INNER BOX QTY. 20 PCS
1.5"	1"

WIRING

3 BULLET PLUGS

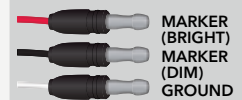

Assemble with any Triple Female Wire Harness.

WARNING: Cancer and Reproductive Harm - www.p65warnings.ca.gov

TOP SELLERS 3/4" ROUND LEDs ARE NOW AVAILABLE IN A POS BOX



TRX-140: AMBER 3/4" LEDs
TRX-142: RED 3/4" LEDs

SEE PAGE 309
FOR MORE INFORMATION



3/4" ROUND - 1 LED GROMMET, TWIST ON NUT & BEZEL - MARKER - 2 WIRES



▲ AMBER MARKER
TLED-B1A



▲ CLEAR AMBER MARKER
TLED-B1CA



▲ RED MARKER
TLED-B1R



▲ CLEAR RED MARKER
TLED-B1CR

2-IN-1 INSTALLATION

New and Improved 3/4" Round LEDs come with Two Installation Options:

GROMMET INSTALLATION





NUT & THREAD INSTALLATION



TECHNICAL SPECIFICATIONS

DIODES	1 Diode
MARKER	TLED-B1A, TLED-B1CA, TLED-B1R, TLED-B1CR
CURRENT DRAW	35 mA
LENS MATERIAL	Polycarbonate
WARRANTY	3 Years

ACCESSORY OPTIONS

WIRE HARNESS (pg. 117-118)	D Series
 CASE QTY. 100 PCS	 INNER BOX QTY. 20 PCS

WIRING

2 BULLET PLUGS



Assemble with any Double Female Wire Harness.

LED LIGHTING

2" ROUND - 9 LEDS GROMMET MOUNT - MARKER

**TOP
SELLER**

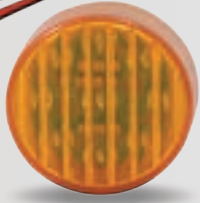

▲ **AMBER MARKER
TLED-2A**

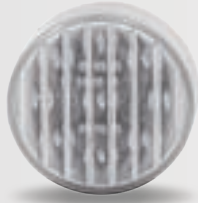

▲ **CLEAR AMBER MARKER
TLED-2TA**



▲ **RED MARKER
TLED-2R**

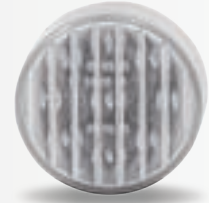

▲ **CLEAR RED MARKER
TLED-2TR**

TECHNICAL SPECIFICATIONS

DOT/SAE	Compliant
DIODES	9 Diodes
MARKER	TLED-2A, TLED-2TA, TLED-2R, TLED-2TR
CURRENT DRAW	31 mA ~ 39 mA
LENS MATERIAL	Polycarbonate
WARRANTY	3 Years

ACCESSORY OPTIONS

GROMMETS (pg. 115)	TGRO-2R, TGRO-2RC
WIRE HARNESS (pg. 117-118)	B Series, TPIG-2W
BEZELS (pg. 113)	TBEZ-2CH2, TBEZ-2CH3, TBEZ-2CH4, TBEZ-2CH5

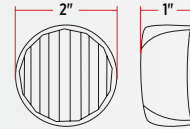
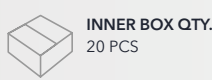

WIRING

2 PRONG ADAPTER



Assemble with any standard
2 Prong Male Wire Harness.

TOP SELLERS
2" ROUND LEDS ARE
NOW AVAILABLE
IN A POS BOX



TRX-223: AMBER 2" LEDS
TRX-224: RED 2" LEDS

SEE PAGE 310 FOR MORE
INFORMATION

⚠ WARNING: Cancer and Reproductive Harm - www.p65warnings.ca.gov

2" ROUND - 7 LEDS

GROMMET MOUNT - MARKER

NEW

▲ **AMBER MARKER**
TLED-2XA



▲ **CLEAR AMBER MARKER**
TLED-2XCA

NEW

▲ **RED MARKER**
TLED-2XR



▲ **CLEAR RED MARKER**
TLED-2XCR

TECHNICAL SPECIFICATIONS

DOT/SAE	Compliant
DIODES	7 Diodes
MARKER	TLED-2XA, TLED-2XCA, TLED-2XR, TLED-2XCR
CURRENT DRAW	80 mA
LENS MATERIAL	Polycarbonate
WARRANTY	3 Years

ACCESSORY OPTIONS

GROMMETS (pg. 115)	TGRO-2R, TGRO-2RC
WIRE HARNESS (pg. 116-118)	B Series, TPIG-2W
BEZELS (pg. 113)	TBEZ-2CH2, TBEZ-2CH3, TBEZ-2CH4, TBEZ-2CH5



CASE QTY.
100 PCS



INNER BOX QTY.
20 PCS

**WIRING****2 PRONG ADAPTER**

Assemble with any standard
2 Prong Male Wire Harness.

2" ROUND FLATLINE - 9 LEDS

GROMMET MOUNT - MARKER

[PATENTED DESIGN]



▲ **AMBER MARKER**
TLED-F2A



▲ **CLEAR AMBER MARKER**
TLED-F2CA



▲ **RED MARKER**
TLED-F2R



▲ **CLEAR RED MARKER**
TLED-F2CR

TECHNICAL SPECIFICATIONS

DIODES	9 Diodes
MARKER	TLED-F2A, TLED-F2R, TLED-F2CA, TLED-F2CR
CURRENT DRAW	35 mA
LENS MATERIAL	Polycarbonate
WARRANTY	3 Years

ACCESSORY OPTIONS

GROMMETS (pg. 115)	TGRO-2R, TGRO-2RC
WIRE HARNESS (pg. 116-118)	B Series, TPIG-2W
BEZELS (pg. 113)	TBEZ-2CH2, TBEZ-2CH3, TBEZ-2CH4, TBEZ-2CH5



CASE QTY.
100 PCS



INNER BOX QTY.
20 PCS

**WIRING****2 PRONG ADAPTER**

Assemble with any standard
2 Prong Male Wire Harness.

LED LIGHTING

TOP SELLERS
2.5" ROUND LEDS ARE
NOW AVAILABLE
IN A POS BOX



TRX-235: AMBER 2.5" LEDS
 TRX-236: RED 2.5" LEDS

SEE PAGE 311 FOR
 MORE INFORMATION



2.5" ROUND - 13 LEDS

GROMMET MOUNT - MARKER

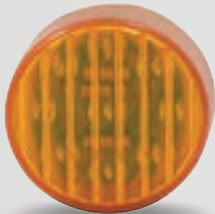

▲
AMBER MARKER
TLED-2HA

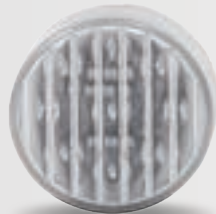

▲
CLEAR AMBER MARKER
TLED-2HTA



▲
RED MARKER
TLED-2HR

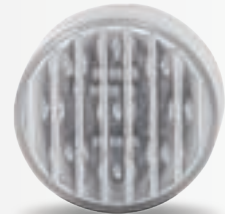

▲
CLEAR RED MARKER
TLED-2HTR

TECHNICAL SPECIFICATIONS

DOT/SAE	Compliant
DIODES	13 Diodes
MARKER	TLED-2HA, TLED-2HR, TLED-2HTA, TLED-2HTR
CURRENT DRAW	51 mA ~ 72 mA
LENS MATERIAL	Polycarbonate
WARRANTY	3 Years

ACCESSORY OPTIONS

GROMMETS (pg. 115)	TGRO-2HRO, TGRO-2HR
WIRE HARNESS (pg. 116-118)	B Series, TPIG-2W
BEZELS (pg. 113)	TBEZ-2HCH2, TBEZ-2HCH3, TBEZ-2HCH4, TBEZ-2HCH5

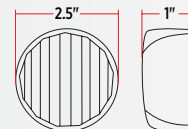
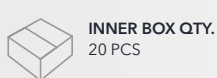

WIRING

2 PRONG ADAPTER



Assemble with any standard
 2 Prong Male Wire Harness.

⚠ WARNING: Cancer and Reproductive Harm - www.p65warnings.ca.gov

2.5" ROUND - 7 LEDS

GROMMET MOUNT - MARKER



CLEAR AMBER MARKER
TLED-2HXCA



CLEAR RED MARKER
TLED-2HXCR

TECHNICAL SPECIFICATIONS

DOT/SAE	Compliant
DIODES	7 Diodes
MARKER	TLED-2HXCA, TLED-2HXCR
CURRENT DRAW	80 mA
LENS MATERIAL	Polycarbonate
WARRANTY	3 Years

ACCESSORY OPTIONS

GROMMETS (pg. 115)	TGRO-2HRO, TGRO-2HR
WIRE HARNESS (pg. 116-118)	B Series, TPIG-2W
BEZELS (pg. 113)	TBEZ-2HCH2, TBEZ-2HCH3, TBEZ-2HCH4, TBEZ-2HCH5



CASE QTY.
100 PCS



INNER BOX QTY.
20 PCS

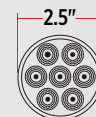

WIRING

2 PRONG ADAPTER



Assemble with any standard
2 Prong Male Wire Harness.

2" BEEHIVE - 9 LEDS

GROMMET MOUNT - MARKER



AMBER MARKER
TLED-2BA



RED MARKER
TLED-2BR

TECHNICAL SPECIFICATIONS

DOT/SAE	Compliant
DIODES	9 Diodes
MARKER	TLED-2BA, TLED-2BR
CURRENT DRAW	50 mA
LENS MATERIAL	Polycarbonate
WARRANTY	3 Years

ACCESSORY OPTIONS

GROMMETS (pg. 115)	TGRO-2R, TGRO-2RC
WIRE HARNESS (pg. 116-118)	B Series, TPIG-2W
BEZELS (pg. 113)	TBEZ-2CH2, TBEZ-2CH3, TBEZ-2CH4, TBEZ-2CH5



CASE QTY.
100 PCS



INNER BOX QTY.
20 PCS

WIRING

2 PRONG ADAPTER



Assemble with any standard
2 Prong Male Wire Harness.



2.5" BEEHIVE - 13 LEDS

GROMMET MOUNT - MARKER



AMBER MARKER
TLED-2HBA

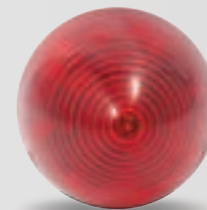

RED MARKER
TLED-2HBR

TECHNICAL SPECIFICATIONS

DOT/SAE	Compliant
DIODES	13 Diodes
MARKER	TLED-2HBA, TLED-2HBR
CURRENT DRAW	71 mA
LENS MATERIAL	Polycarbonate
WARRANTY	3 Years

ACCESSORY OPTIONS

GROMMETS (pg. 115)	TGRO-2HR, TGRO-2HRO
WIRE HARNESS (pg. 116-118)	B Series, TPIG-2W
BEZELS (pg. 113)	TBEZ-2HCH2, TBEZ-2HCH3, TBEZ-2HCH4, TBEZ-2HCH5



CASE QTY.
100 PCS



INNER BOX QTY.
20 PCS

WIRING

2 PRONG ADAPTER



Assemble with any standard
2 Prong Male Wire Harness.

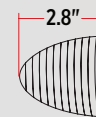

LED LIGHTING

**TOP
SELLER**

GENERATION 4 - 4 LEDS MARKER



▲ **AMBER MARKER
TLED-G4A**



▲ **CLEAR AMBER MARKER
TLED-G4CA**



▲ **RED MARKER
TLED-G4R**



▲ **CLEAR RED MARKER
TLED-G4CR**

TECHNICAL SPECIFICATIONS

DOT/SAE	Compliant
DIODES	4 Diodes
MARKER	TLED-G4A, TLED-G4CA, TLED-G4R, TLED-G4CR
CURRENT DRAW	29 mA ~ 30 mA
LENS MATERIAL	Polycarbonate
WARRANTY	3 Years

ACCESSORY OPTIONS

WIRE HARNESS (pg. 117)	D Series
------------------------	----------

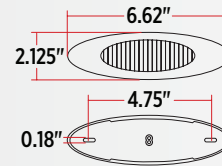
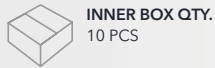

WIRING

2 BULLET PLUGS

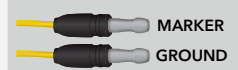

Assemble with any Double Female Wire Harness.

**TOP SELLERS
GENERATION 4
MARKER LEDS ARE
NOW AVAILABLE
IN A POS BOX**

TRX-238

SEE PAGE 312 FOR MORE INFORMATION



⚠ WARNING: Cancer and Reproductive Harm - www.p65warnings.ca.gov

**TOP
SELLER****GENERATION 2 - 2 LEDS
MARKER****AMBER MARKER
TLED-G2A****CLEAR AMBER MARKER
TLED-G2CA****RED MARKER
TLED-G2R****CLEAR RED MARKER
TLED-G2CR****TECHNICAL SPECIFICATIONS**

DOT/SAE	Compliant
DIODES	2 Diodes
MARKER	TLED-G2A, TLED-G2CA, TLED-G2R, TLED-G2CR
CURRENT DRAW	40 mA
LENS MATERIAL	Polycarbonate
WARRANTY	3 Years

ACCESSORY OPTIONS

WIRE HARNESS (pg. 117)	D Series
------------------------	----------

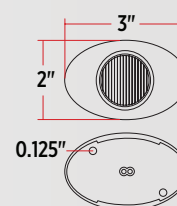
CASE QTY.
100 PCSINNER BOX QTY.
20 PCS**WIRING****2 BULLET PLUGS**Assemble with any Double
Female Wire Harness.

WARNING: Cancer and Reproductive Harm - www.p65warnings.ca.gov

LED LIGHTING

GENERATION 4 - 10 LEDS MARKER

NEW



▲ AMBER MARKER
TLED-G4XA



▲ CLEAR AMBER MARKER
TLED-G4XCA

NEW



▲ RED MARKER
TLED-G4XR



▲ CLEAR RED MARKER
TLED-G4XCR

TECHNICAL SPECIFICATIONS

DOT/SAE	Compliant
DIODES	10 Diodes
MARKER	TLED-G4XCA, TLED-G4XCR, TLED-G4XA, TLED-G4XR
CURRENT DRAW	120 mA
LENS MATERIAL	Polycarbonate
WARRANTY	3 Years

ACCESSORY OPTIONS

WIRE HARNESS (pg. 117)

D Series



CASE QTY.
100 PCS



INNER BOX QTY.
10 PCS

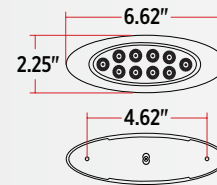

WIRING

2 BULLET PLUGS



Assemble with any Double Female Wire Harness.



GENERATION 2 - 4 LEDS MARKER

NEW



▲ AMBER MARKER
TLED-G2XA



▲ CLEAR AMBER MARKER
TLED-G2XCA

NEW



▲ RED MARKER
TLED-G2XR



▲ CLEAR RED MARKER
TLED-G2XCR

TECHNICAL SPECIFICATIONS

DOT/SAE	Compliant
DIODES	4 Diodes
MARKER	TLED-G2XCA, TLED-G2XCR, TLED-G2XA, TLED-G2XR
CURRENT DRAW	40 mA
LENS MATERIAL	Polycarbonate
WARRANTY	3 Years

ACCESSORY OPTIONS

WIRE HARNESS (pg. 117)

D Series



CASE QTY.
100 PCS



INNER BOX QTY.
10 PCS

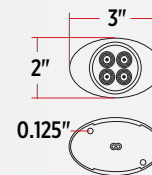

WIRING

2 BULLET PLUGS



Assemble with any Double Female Wire Harness.

⚠ WARNING: Cancer and Reproductive Harm - www.p65warnings.ca.gov

FLATLINE GENERATION 4 - 32 LEDS MARKER

[PATENTED DESIGN]



▲
AMBER MARKER
TLED-FGA



▲
CLEAR AMBER MARKER
TLED-FGCA



▲
RED MARKER
TLED-FGR



▲
CLEAR RED MARKER
TLED-FGCR

TECHNICAL SPECIFICATIONS

DIODES	32 Diodes
MARKER	TLED-FGA, TLED-FGCA, TLED-FGR, TLED-FGCR
CURRENT DRAW	71 mA ~ 72 mA
LENS MATERIAL	Polycarbonate
WARRANTY	3 Years

ACCESSORY OPTIONS

WIRE HARNESS (pg. 117)

D Series

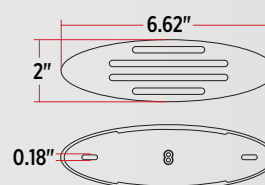
CASE QTY.
100 PCSINNER BOX QTY.
20 PCS

WIRING

2 BULLET PLUGS



Assemble with any Double Female Wire Harness.



FLATLINE GENERATION 2 - 13 LEDS MARKER



▲
AMBER MARKER
TLED-FG2A



▲
CLEAR AMBER MARKER
TLED-FG2CA



▲
RED MARKER
TLED-FG2R



▲
CLEAR RED MARKER
TLED-FG2CR

TECHNICAL SPECIFICATIONS

DIODES	13 Diodes
MARKER	TLED-FG2A, TLED-FG2CA, TLED-FG2R, TLED-FG2CR
CURRENT DRAW	35 ~ 40 mA
LENS MATERIAL	Polycarbonate
WARRANTY	3 Years

ACCESSORY OPTIONS

WIRE HARNESS (pg. 117)

D Series

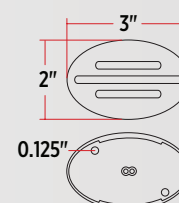
CASE QTY.
100 PCSINNER BOX QTY.
20 PCS

WIRING

2 BULLET PLUGS



Assemble with any Double Female Wire Harness.

⚠ WARNING: Cancer and Reproductive Harm - www.p65warnings.ca.gov

LED LIGHTING

WATERMELON - 19 LEDS TURN & MARKER



▲
AMBER TURN & MARKER
TLED-WA



▲
CLEAR AMBER TURN & MARKER
TLED-WCA



▲
RED TURN & MARKER
TLED-WR



▲
CLEAR RED TURN & MARKER
TLED-WCR

TECHNICAL SPECIFICATIONS

DOT/SAE	Compliant
DIODES	19 Diodes
TURN & MARKER	TLED-WA, TLED-WCA, TLED-WR, TLED-WCR
CURRENT DRAW	240 mA
LENS MATERIAL	Polycarbonate
WARRANTY	3 Years

ACCESSORY OPTIONS

WIRE HARNESS (pg. 118)	T-Series
------------------------	----------

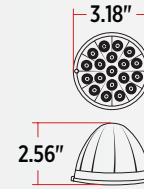
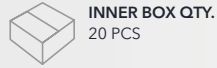

WIRING

3 BULLET PLUGS



Assemble with any Triple Female Wire Harness.



⚠ WARNING: Cancer and Reproductive Harm - www.p65warnings.ca.gov

PETERBILT CAB - 19 LEDS WITH HOUSING - MARKER



AMBER MARKER
TLED-PCAB2



CLEAR AMBER MARKER
TLED-PCABC2

TECHNICAL SPECIFICATIONS

DOT/SAE	Compliant
DIODES	19 Diodes
MARKER	TLED-PCAB2, TLED-PCABC2
CURRENT DRAW	60 mA
LENS MATERIAL	Polycarbonate
WARRANTY	3 Years

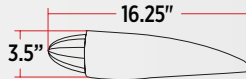
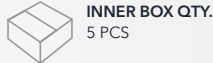

PETERBILT CAB - 19 LEDS MARKER



AMBER MARKER
TLED-PCAB



CLEAR AMBER MARKER
TLED-PCABC

TECHNICAL SPECIFICATIONS

DOT/SAE	Compliant
DIODES	19 Diodes
MARKER	TLED-PCAB, TLED-PCABC
CURRENT DRAW	60 mA
LENS MATERIAL	Polycarbonate
WARRANTY	3 Years

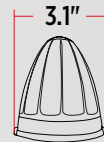
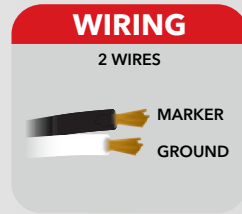

SQUARE CAB - 42 LEDS WITH HOUSING - MARKER



AMBER MARKER
TLED-CAB2



CLEAR AMBER MARKER
TLED-CABC2

TECHNICAL SPECIFICATIONS

DOT/SAE	Compliant
DIODES	42 Diodes
MARKER	TLED-CAB2, TLED-CABC2
CURRENT DRAW	146 mA
LENS MATERIAL	Polycarbonate
WARRANTY	3 Years

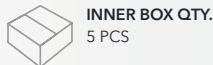

SQUARE CAB - 42 LEDS MARKER



AMBER MARKER
TLED-CAB



CLEAR AMBER MARKER
TLED-CABC

TECHNICAL SPECIFICATIONS

DOT/SAE	Compliant
DIODES	42 Diodes
MARKER	TLED-CAB, TLED-CABC
CURRENT DRAW	146 mA
LENS MATERIAL	Polycarbonate
WARRANTY	3 Years

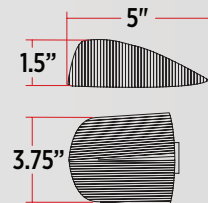
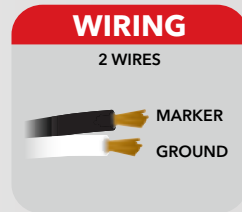
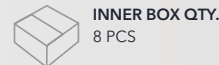

LED LIGHTING

INFINITY STANDARD - 13 LEDS MARKER



▲
AMBER MARKER
TLED-INFA



▲
CLEAR AMBER MARKER
TLED-INFCA



▲
RED MARKER
TLED-INFR



▲
CLEAR RED MARKER
TLED-INFCR

TECHNICAL SPECIFICATIONS

DOT/SAE	Compliant
DIODES	13 Diodes
MARKER	TLED-INFA, TLED-INFR, TLED-INFCA, TLED-INFCR
CURRENT DRAW	63 mA ~ 64 mA
LENS MATERIAL	Polycarbonate
WARRANTY	3 Years

ACCESSORY OPTIONS

WIRE HARNESS (pg. 117)	D Series
------------------------	----------

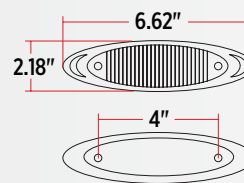
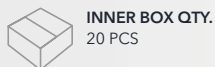

WIRING

2 BULLET PLUGS



Assemble with any Double Female Wire Harness.



INFINITY SMALL - 6 LEDS MARKER



▲
AMBER MARKER
TLED-INF2A



▲
CLEAR AMBER MARKER
TLED-INF2CA



▲
RED MARKER
TLED-INF2R



▲
CLEAR RED MARKER
TLED-INF2CR

TECHNICAL SPECIFICATIONS

DOT/SAE	Compliant
DIODES	6 Diodes
MARKER	TLED-INF2A, TLED-INF2CA, TLED-INF2R, TLED-INF2CR
CURRENT DRAW	19 mA ~ 26 mA
LENS MATERIAL	Polycarbonate
WARRANTY	3 Years

ACCESSORY OPTIONS

WIRE HARNESS (pg. 117)	D Series
------------------------	----------

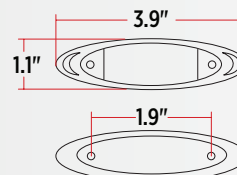
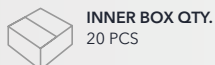

WIRING

2 BULLET PLUGS



Assemble with any Double Female Wire Harness.

⚠ WARNING: Cancer and Reproductive Harm - www.p65warnings.ca.gov

1" X 4" - 12 LEDS MARKER



▲
AMBER MARKER
TLED-1X4A



▲
RED MARKER
TLED-1X4R

TECHNICAL SPECIFICATIONS

DOT/SAE	Compliant
DIODES	12 Diodes
MARKER	TLED-1X4A, TLED-1X4R
CURRENT DRAW	40 mA
LENS MATERIAL	Polycarbonate
WARRANTY	3 Years

ACCESSORY OPTIONS

WIRE HARNESS	B Series, TPIG-2W (pg. 116, 118)
--------------	-------------------------------------

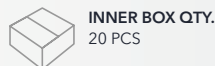

1" X 2" - 6 LEDS MARKER



▲
AMBER MARKER
TLED-1X2A



▲
RED MARKER
TLED-1X2R

TECHNICAL SPECIFICATIONS

DOT/SAE	Compliant
DIODES	6 Diodes
MARKER	TLED-1X2A, TLED-1X2R
CURRENT DRAW	39 mA
LENS MATERIAL	Polycarbonate
WARRANTY	3 Years

ACCESSORY OPTIONS

WIRE HARNESS	B Series, TPIG-2W (pg. 116, 118)
--------------	-------------------------------------

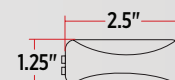
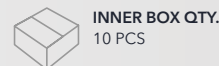

2" X 6" - 8 LEDS REFLECTORIZED - MARKER



▲
AMBER MARKER
TLED-2X6RA



▲
RED MARKER
TLED-2X6RR

TECHNICAL SPECIFICATIONS

DOT/SAE	Compliant
DIODES	8 Diodes
MARKER	TLED-2X6RA, TLED-2X6RR
CURRENT DRAW	46 mA
LENS MATERIAL	Polycarbonate
WARRANTY	3 Years

ACCESSORY OPTIONS

WIRE HARNESS	D Series (pg. 117)
--------------	--------------------

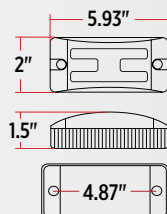

2" X 6" - 18 LEDS TURN & MARKER



▲
AMBER TURN & MARKER
TLED-2X6SA



▲
CLEAR AMBER TURN & MARKER
TLED-2X6SCA

TECHNICAL SPECIFICATIONS

DOT/SAE	Compliant
DIODES	18 Diodes
TURN & MARKER	TLED-2X6SA, TLED-2X6SCA
CURRENT DRAW	64 mA
LENS MATERIAL	Polycarbonate
WARRANTY	3 Years

ACCESSORY OPTIONS

WIRE HARNESS	B612, TPIG-3W (pg. 116-118)
--------------	--------------------------------

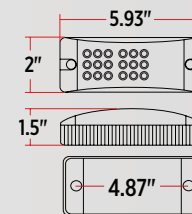
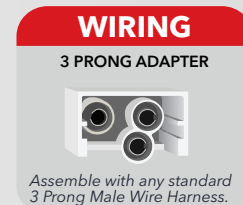

LED LIGHTING

2" X 6" - 20 LEDS MARKER



▲
AMBER MARKER
TLED-2X6A



▲
CLEAR AMBER MARKER
TLED-2X6CA



▲
RED MARKER
TLED-2X6R



▲
CLEAR RED MARKER
TLED-2X6CR

TECHNICAL SPECIFICATIONS

DOT/SAE	Compliant
DIODES	20 Diodes
MARKER	TLED-2X6A, TLED-2X6R, TLED-2X6CA, TLED-2X6CR
CURRENT DRAW	70 mA ~ 80 mA
LENS MATERIAL	Polycarbonate
WARRANTY	3 Years

ACCESSORY OPTIONS

WIRE HARNESS (pg. 117)	D Series
------------------------	----------



CASE QTY.
40 PCS



INNER BOX QTY.
10 PCS

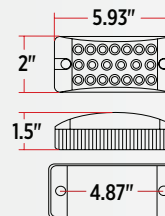

WIRING

2 BULLET PLUGS

Assemble with any Double Female Wire Harness.

2" X 6" - 24 LEDS MULTI-DIRECTIONAL - MARKER



▲
AMBER MARKER
TLED-2X6DA



▲
CLEAR AMBER MARKER
TLED-2X6DCA



▲
RED MARKER
TLED-2X6DR



▲
CLEAR RED MARKER
TLED-2X6DCR

TECHNICAL SPECIFICATIONS

DOT/SAE	Compliant
DIODES	24 Diodes
MARKER	TLED-2X6DA, TLED-2X6DR, TLED-2X6DCA, TLED-2X6DCR
CURRENT DRAW	56 mA ~ 59 mA
LENS MATERIAL	Polycarbonate
WARRANTY	3 Years

ACCESSORY OPTIONS

WIRE HARNESS (pg. 117)	D Series
------------------------	----------



CASE QTY.
40 PCS



INNER BOX QTY.
10 PCS

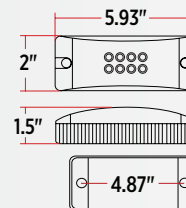

WIRING

2 BULLET PLUGS

Assemble with any Double Female Wire Harness.



⚠ WARNING: Cancer and Reproductive Harm - www.p65warnings.ca.gov

DOUBLE BULLSEYE - 16 LEDS MARKER



AMBER MARKER
TLED-BA

RED MARKER
TLED-BR

TECHNICAL SPECIFICATIONS

DOT/SAE	Compliant
DIODES	16 Diodes
MARKER	TLED-BA, TLED-BR
CURRENT DRAW	50 mA ~ 60 mA
LENS MATERIAL	Polycarbonate
WARRANTY	3 Years

ACCESSORY OPTIONS

WIRE HARNESS	S Series (pg. 117)
--------------	--------------------



CASE QTY.
100 PCS



INNER BOX QTY.
20 PCS

WIRING

1 BULLET PLUG



Assemble with any Single Female Wire Harness.

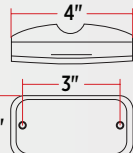

SQUARE - 32 LEDS GROMMET MOUNT - TURN & MARKER



RED S, T & T
TLED-SQR1

TECHNICAL SPECIFICATIONS

DOT/SAE	Compliant
DIODES	32 Diodes
STOP, TURN & TAIL	TLED-SQR1
CURRENT DRAW	90 mA
LENS MATERIAL	Polycarbonate
WARRANTY	3 Years

ACCESSORY OPTIONS

GROMMETS	TGRO-SQR (pg. 115)
WIRE HARNESS	B612, TPIG-3W (pg. 116-118)
BEZELS	TBEZ-SQR (pg. 115)



CASE QTY.
5 PCS



INNER BOX QTY.
4 PCS

WIRING

3 PRONG ADAPTER



Assemble with any standard 3 Prong Male Wire Harness.

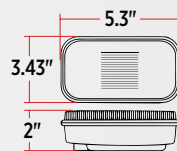

OVAL HUMP - 18 LEDS GROMMET MOUNT - TURN & MARKER



AMBER TURN & MARKER
TLED-HOBA

TECHNICAL SPECIFICATIONS

DOT/SAE	Compliant
DIODES	18 Diodes
TURN & MARKER	TLED-HOBA
CURRENT DRAW	130 mA
LENS MATERIAL	Polycarbonate
WARRANTY	3 Years

ACCESSORY OPTIONS

GROMMETS	TGRO-OBR, TGRO-OBRC (pg. 115)
WIRE HARNESS	B612, TPIG-3W (pg. 116-118)
BEZELS	TBEZ-OLR, TBEZ-OBCH2, TBEZ-OBCH3, TBEZ-OBCH4, TBEZ-OBCH5 (pg. 116)

WIRING

3 PRONG ADAPTER



Assemble with any standard 3 Prong Male Wire Harness.

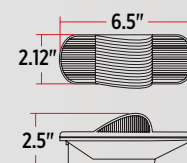

THIN LINE - 7 LEDS MARKER



RED MARKER
TLED-TLA

RED MARKER
TLED-TLR

TECHNICAL SPECIFICATIONS

DOT/SAE	Compliant
DIODES	7 Diodes
MARKER	TLED-TLA, TLED-TLR
CURRENT DRAW	39 mA
LENS MATERIAL	Polycarbonate
WARRANTY	3 Years

ACCESSORY OPTIONS

WIRE HARNESS	D Series (pg. 117)
--------------	--------------------



CASE QTY.
100 PCS



INNER BOX QTY.
20 PCS

WIRING

2 BULLET PLUGS



Assemble with any Double Female Wire Harness.

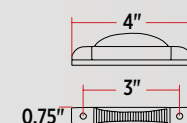

LED LIGHTING

PETERBILT SIDE LIGHT FOR HEADLIGHT - 24 LEDS TURN & MARKER



▲ AMBER TURN & MARKER
TLED-PSH



▲ CLEAR AMBER TURN & MARKER
TLED-PSHC

TECHNICAL SPECIFICATIONS

DIODES	24 Diodes
TURN & MARKER	TLED-PSH, TLED-PSHC
CURRENT DRAW	310 mA
LENS MATERIAL	Polycarbonate
WARRANTY	3 Years



CASE QTY.
100 PCS



INNER BOX QTY.
10 PCS

WIRING

3 WIRES

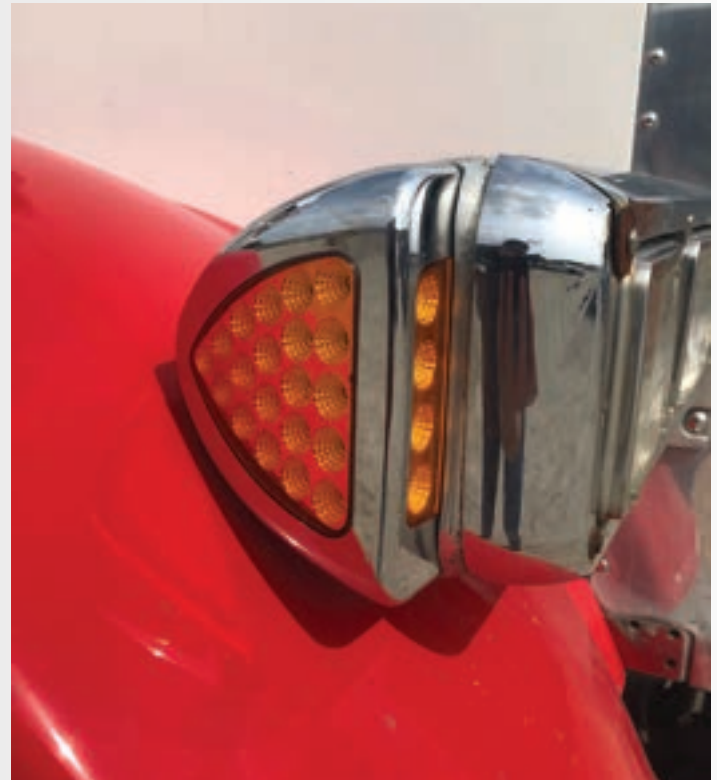
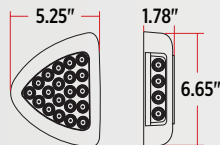

PETERBILT - 12 LEDS MARKER



▲ AMBER MARKER
TLED-PETA



▲ CLEAR AMBER MARKER
TLED-PETCA



▲ RED MARKER
TLED-PETR

TECHNICAL SPECIFICATIONS

DOT/SAE	Compliant
DIODES	12 Diodes
MARKER	TLED-PETA, TLED-PETCA, TLED-PETR
CURRENT DRAW	60 mA
LENS MATERIAL	Polycarbonate
WARRANTY	3 Years

ACCESSORY OPTIONS

WIRE HARNESS (pg. 117)	S Series
------------------------	----------



CASE QTY.
100 PCS



INNER BOX QTY.
20 PCS

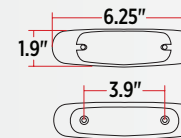

WIRING

1 BULLET PLUG & TERMINAL



Assemble with any Single Female Wire Harness.

HEADLIGHT BEZELS - 51 LEDS MARKER



▲ CLEAR AMBER MARKER
TU-1029



▲ AMBER MARKER
TU-1029A



▲ WHITE MARKER
TU-1029W

TECHNICAL SPECIFICATIONS

DOT/SAE	Compliant
DIODES	51 Diodes
MARKER	TU-1029, TU-1029A, TU-1029W
CURRENT DRAW	550 mA
LENS MATERIAL	Polycarbonate
SOLD	Individually
WARRANTY	3 Years



CASE QTY.
20 PCS



INNER BOX QTY.
4 PCS

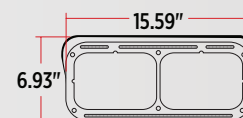

WIRING

3 WIRES

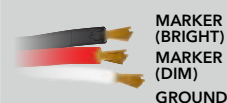

MINI FLATLINE - 8 LEDS MARKER



▲ AMBER MARKER
TLED-FG3A



▲ CLEAR AMBER MARKER
TLED-FG3CA



▲ RED MARKER
TLED-FG3R



▲ CLEAR RED MARKER
TLED-FG3CR

TECHNICAL SPECIFICATIONS

DIODES	8 Diodes
MARKER	TLED-FG3A, TLED-FG3R, TLED-FG3CA, FG3CR
CURRENT DRAW	18 ~ 19 mA
LENS MATERIAL	Polycarbonate
WARRANTY	3 Years

ACCESSORY OPTIONS

WIRE HARNESS (pg. 117)	D Series
------------------------	----------



CASE QTY.
100 PCS



INNER BOX QTY.
20 PCS

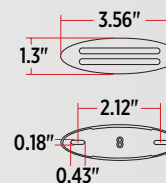

WIRING

2 BULLET PLUGS & TERMINAL



Assemble with any Double Female Wire Harness.

⚠ WARNING: Cancer and Reproductive Harm - www.p65warnings.ca.gov

LED LIGHTING

PETERBILT FENDER - 4 LEDS TURN & MARKER



BACK

AMBER TURN & MARKER
TLED-PA

TECHNICAL SPECIFICATIONS

DOT/SAE	Compliant
DIODES	4 Diodes
TURN & MARKER	TLED-PA
CURRENT DRAW	60 mA
LENS MATERIAL	Polycarbonate
WARRANTY	3 Years

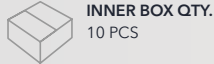

WIRING
2 WIRES & TERMINAL

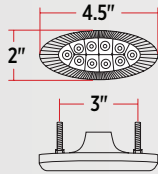

PETERBILT FENDER - 15 LEDS FLATLINE - TURN & MARKER



AMBER TURN & MARKER
TLED-FPA

CLEAR AMBER TURN & MARKER
TLED-FPCA

TECHNICAL SPECIFICATIONS

DIODES	15 Diodes
TURN & MARKER	TLED-FPA, TLED-FPCA
CURRENT DRAW	55 mA
LENS MATERIAL	Polycarbonate
WARRANTY	3 Years

ACCESSORY OPTIONS

WIRE HARNESS	D Series (pg. 117)
--------------	--------------------

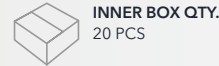

WIRING
2 BULLETS & TERMINAL

Assemble with any Double Female Wire Harness.

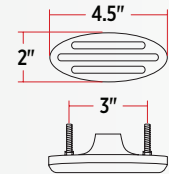

FTL. CAB LIGHT - 20 LEDS MARKER

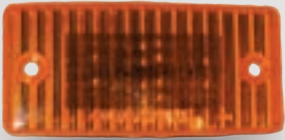

AMBER MARKER
TLED-FTLA

CLEAR AMBER MARKER
TLED-FTLCA

TECHNICAL SPECIFICATIONS

DOT/SAE	Compliant
DIODES	20 Diodes
MARKER	TLED-FTLA, TLED-FTLCA
CURRENT DRAW	50 mA
LENS MATERIAL	Polycarbonate
WARRANTY	3 Years

ACCESSORY OPTIONS

WIRE HARNESS	B Series, TPIG-2W (pg. 116-118)
--------------	---------------------------------

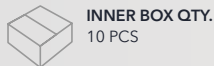

WIRING
3 PRONG ADAPTER

Assemble with any standard 2 Prong Pigtail.

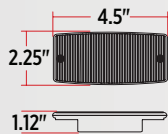

FTL. SLEEPER LIGHT - 35 LEDS TURN & MARKER

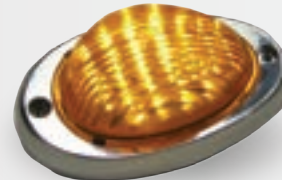

AMBER TURN & MARKER
TLED-FLCA

CLEAR AMBER TURN & MARKER
TLED-FLCAC

TECHNICAL SPECIFICATIONS

DOT/SAE	Compliant
DIODES	35 Diodes
TURN & MARKER	TLED-FLCA, TLED-FLCAC
CURRENT DRAW	130 mA
LENS MATERIAL	Polycarbonate
WARRANTY	3 Years

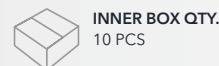

WIRING
2 WIRES & TERMINAL

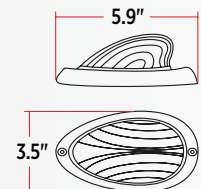

WARNING: Cancer and Reproductive Harm - www.p65warnings.ca.gov

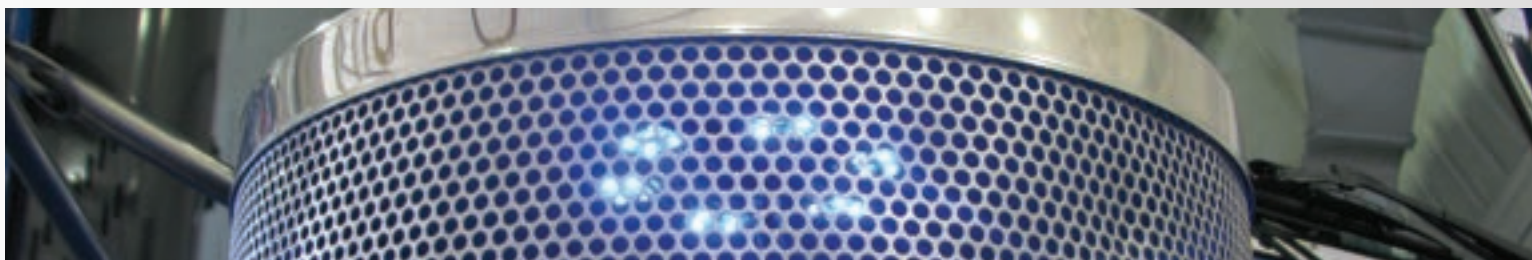

8" STAR - 24 LEDs AUXILIARY

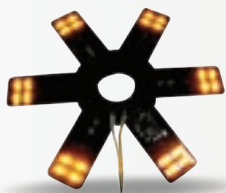

▲ AMBER AUXILIARY
TLED-X1A

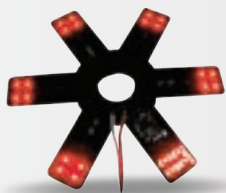

▲ RED AUXILIARY
TLED-X1R

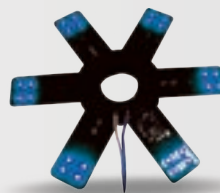

▲ BLUE AUXILIARY
TLED-X1B

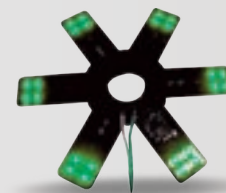

▲ GREEN AUXILIARY
TLED-X1G

TECHNICAL SPECIFICATIONS

DIODES	24 Diodes
AUXILIARY	TLED-X1A, TLED-X1R, TLED-X1B, TLED-X1G
CURRENT DRAW	140 mA ~ 150 mA
LENS MATERIAL	Polycarbonate
WARRANTY	3 Years
ACCESSORY OPTIONS	
WIRE HARNESS	D Series (pg. 117)

▶ ALL 8" Star LEDs are designed to fit
15" Donaldson & Vortex Air Cleaners
Clean surface with water & soap.
Install Star LED with 3M adhesive (Included).



CASE QTY.
50 PCS

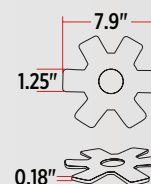

WIRING

2 BULLET PLUGS



Assemble with any Double
Female Wire Harness.

5" STAR - 24 LEDs AUXILIARY



▲ AMBER AUXILIARY
TLED-X3A



▲ RED AUXILIARY
TLED-X3R

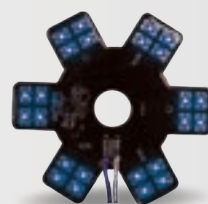

▲ BLUE AUXILIARY
TLED-X3B

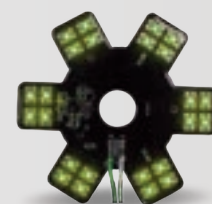

▲ GREEN AUXILIARY
TLED-X3G

TECHNICAL SPECIFICATIONS

DIODES	24 Diodes
AUXILIARY	TLED-X3A, TLED-X3R, TLED-X3B, TLED-X3G
CURRENT DRAW	140 mA ~ 180 mA
LENS MATERIAL	Polycarbonate
WARRANTY	3 Years
ACCESSORY OPTIONS	
WIRE HARNESS	D Series (pg. 117)

▶ ALL 5" Star LEDs are designed to fit
13" Donaldson & Vortex Air Cleaners
Clean surface with water & soap.
Install Star LED with 3M adhesive (Included).



CASE QTY.
60 PCS

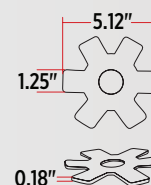

WIRING

2 BULLET PLUGS



Assemble with any Double
Female Wire Harness.

⚠ WARNING: Cancer and Reproductive Harm - www.p65warnings.ca.gov

LED LIGHTING

17" SLIM - 24 LEDS MARKER



▲
AMBER MARKER
TLED-F17A

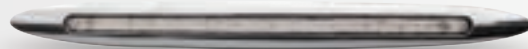

▲
CLEAR AMBER MARKER
TLED-F17CA



▲
RED MARKER
TLED-F17R



▲
CLEAR RED MARKER
TLED-F17CR



▲
WHITE MARKER
TLED-F17W

TECHNICAL SPECIFICATIONS

DIODES	24 Diodes
MARKER	TLED-F17A, TLED-F17CA, TLED-F17R, TLED-F17CR, TLED-F17W
CURRENT DRAW	90 mA
LENS MATERIAL	Polycarbonate
WARRANTY	3 Years

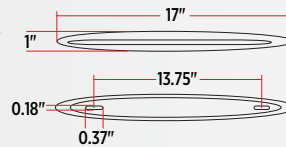
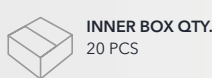

WIRING

3 WIRES



9" SLIM - 14 LEDS MARKER



▲
AMBER MARKER
TLED-F9A



▲
RED MARKER
TLED-F9R



▲
CLEAR AMBER MARKER
TLED-F9CA

TECHNICAL SPECIFICATIONS

DIODES	14 Diodes
MARKER	TLED-F9A, TLED-F9CA, TLED-F9R
CURRENT DRAW	60 mA
LENS MATERIAL	Polycarbonate
WARRANTY	3 Years

ACCESSORY OPTIONS

WIRE HARNESS (pg. 117)	D Series
------------------------	----------

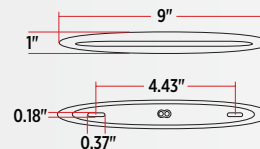
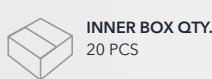

WIRING

2 BULLET PLUGS & TERMINAL

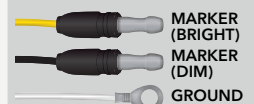

Assemble with any Double Female Wire Harness.

⚠ WARNING: Cancer and Reproductive Harm - www.p65warnings.ca.gov

6" SLIM - 9 LEDS MARKER

[PATENTED DESIGN]



▲
AMBER MARKER
TLED-FG4A



▲
RED MARKER
TLED-FG4R



▲
CLEAR AMBER MARKER
TLED-FG4CA





▲
CLEAR RED MARKER
TLED-FG4CR

TECHNICAL SPECIFICATIONS

DIODES	9 Diodes
MARKER	TLED- FG4A, TLED-FG4CA, TLED-FG4R, TLED-FG4CR
CURRENT DRAW	31 mA ~ 32 mA
LENS MATERIAL	Polycarbonate
WARRANTY	3 Years

ACCESSORY OPTIONS

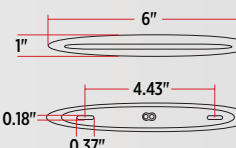
WIRE HARNESS (pg. 117)	D Series
 CASE QTY. 100 PCS	 INNER BOX QTY. 20 PCS
	

WIRING

2 BULLET PLUGS & TERMINAL



Assemble with any Double
Female Wire Harness.



4.5" SLIM - 7 LEDS MARKER



▲
AMBER MARKER
TLED-F45A



▲
RED MARKER
TLED-F45R





▲
CLEAR AMBER MARKER
TLED-F45CA

TECHNICAL SPECIFICATIONS

DIODES	7 Diodes
MARKER	TLED-F45A, TLED-F45CA, TLED-F45R
CURRENT DRAW	20 mA
LENS MATERIAL	Polycarbonate
WARRANTY	3 Years

ACCESSORY OPTIONS

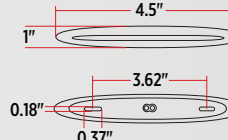
WIRE HARNESS (pg. 117)	D Series
 CASE QTY. 100 PCS	 INNER BOX QTY. 20 PCS
	

WIRING

2 BULLET PLUGS & TERMINAL



Assemble with any Double
Female Wire Harness.

⚠ WARNING: Cancer and Reproductive Harm - www.p65warnings.ca.gov

LED LIGHTING

ROUND SUPER VALUE - 42 LEDS DOUBLE FACE - TURN & MARKER



▲
AMBER/RED TURN & MARKER
TLED-DFF

TECHNICAL SPECIFICATIONS

DOT/SAE	Compliant
DIODES	42 Diodes
TURN & MARKER	TLED-DFF
CURRENT DRAW	180 mA
LENS MATERIAL	Polycarbonate
WARRANTY	3 Years

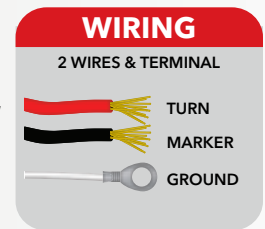
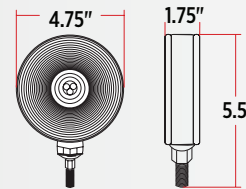
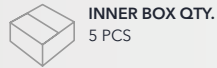

ROUND SUPER DIODE - 34 LEDS DOUBLE FACE - TURN & MARKER



▲
AMBER/RED TURN & MARKER
TLED-DFC2



▲
CLEAR AMBER/RED TURN & MARKER
TLED-DFCC2

TECHNICAL SPECIFICATIONS

DOT/SAE	Compliant
DIODES	34 Diodes
TURN & MARKER	TLED-DFC2, TLED-DFCC2
CURRENT DRAW	290 mA
LENS MATERIAL	Polycarbonate
WARRANTY	3 Years

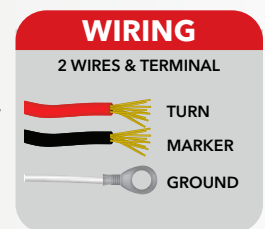
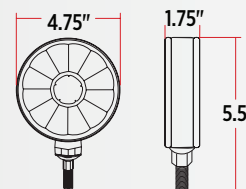
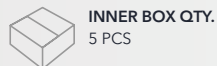

ROUND CHROME REFLECTOR - 38 LEDS

DOUBLE FACE - TURN & MARKER

NEW

FRONT



BACK



AMBER/RED TURN & MARKER
TLED-DFC3

CLEAR AMBER/RED TURN & MARKER
TLED-DFCC3

TECHNICAL SPECIFICATIONS

DOT/SAE	Compliant
DIODES	38 Diodes
TURN & MARKER	TLED-DFCC3, TLED-DFC3
CURRENT DRAW	180 mA
LENS MATERIAL	Polycarbonate
WARRANTY	3 Years

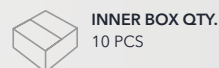

WIRING

2 WIRES & TERMINAL



"OL-SKUL" - 38 LEDS

DOUBLE FACE - TURN & MARKER

FRONT



BACK



AMBER/RED TURN & MARKER
TLED-DFO

AMBER/RED TURN & MARKER
TLED-FD

CLEAR AMBER/RED
TURN & MARKER
TLED-FDC

TECHNICAL SPECIFICATIONS

DIODES	38 Diodes
TURN & MARKER	TLED-DFO
CURRENT DRAW	670 mA
LENS MATERIAL	Polycarbonate
WARRANTY	3 Years

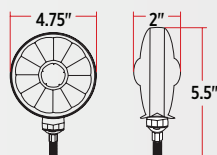
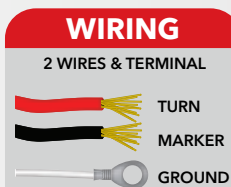
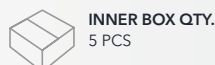

TECHNICAL SPECIFICATIONS

DIODES	74 Diodes
TURN & MARKER	TLED-FD, TLED-FDC
CURRENT DRAW	200 mA
LENS MATERIAL	Polycarbonate
WARRANTY	3 Years

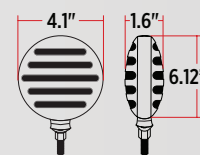
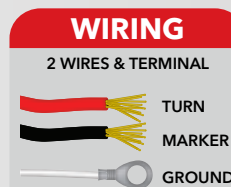

WARNING: Cancer and Reproductive Harm - www.p65warnings.ca.gov

LED LIGHTING

SQUARE CHROME REFLECTOR - 38 LEDS DOUBLE FACE - TURN & MARKER

NEW

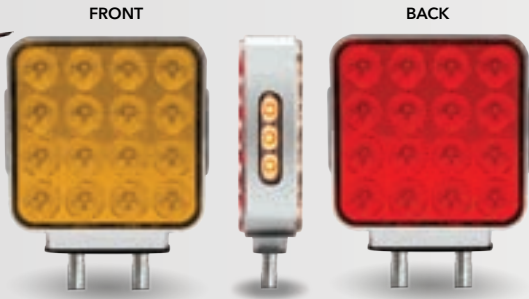

▲
AMBER/RED TURN & MARKER
TLED-SDX



▲
CLEAR AMBER/RED TURN & MARKER
TLED-SDXC

TECHNICAL SPECIFICATIONS

DOT/SAE	Compliant
DIODES	38 Diodes
TURN & MARKER	TLED-SDXC, TLED-SDX
CURRENT DRAW	180 mA
LENS MATERIAL	Polycarbonate
WARRANTY	3 Years



CASE QTY.
50 PCS



INNER BOX QTY.
10 PCS

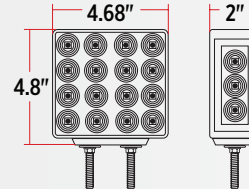

WIRING
2 WIRES & TERMINAL

TURN
MARKER
GROUND

SQUARE FLATLINE - 80 LEDS DOUBLE FACE - TURN & MARKER



▲
AMBER/RED TURN & MARKER
TLED-FS



▲
CLEAR AMBER/RED TURN & MARKER
TLED-FSC

TECHNICAL SPECIFICATIONS

DIODES	80 Diodes
TURN & MARKER	TLED-FS, TLED-FSC
CURRENT DRAW	156 mA
LENS MATERIAL	Polycarbonate
WARRANTY	3 Years



CASE QTY.
100 PCS



INNER BOX QTY.
20 PCS

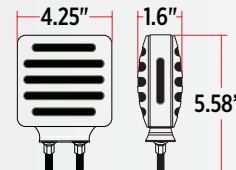

WIRING
2 WIRES & TERMINAL

TURN
MARKER
GROUND

GLOW STRIP LEDS

You've asked and we listened, Trux is proud to announce their new and improved Glow Strip Technology. These powerful LED Glow Strips can be linked to one another and are sold as a center or side glow. It's time to make a statement and be the center of any truck show, creating the illusion that you are under a spotlight. Get yours today to be the star of the show!

FROSTED CENTER GLOW STRIP LEDS

LINK
THE STRIPS
TOGETHER!
REGARDLESS
OF SIZE



12 INCH

TLED-GL12CA: **AMBER**
TLED-GL12CB: **BLUE**
TLED-GL12CG: **GREEN**
TLED-GL12CP: **PURPLE**
TLED-GL12CR: **RED**
TLED-GL12CW: **WHITE**

24 INCH

TLED-GL24CA: **AMBER**
TLED-GL24CB: **BLUE**
TLED-GL24CG: **GREEN**
TLED-GL24CP: **PURPLE**
TLED-GL24CR: **RED**
TLED-GL24CW: **WHITE**

48 INCH

TLED-GL48CA: **AMBER**
TLED-GL48CB: **BLUE**
TLED-GL48CG: **GREEN**
TLED-GL48CP: **PURPLE**
TLED-GL48CR: **RED**
TLED-GL48CW: **WHITE**

LINK
THE STRIPS
TOGETHER!
REGARDLESS
OF SIZE

FROSTED SIDE GLOW STRIP LEDS



12 INCH

TLED-GL12SA: **AMBER**
TLED-GL12SB: **BLUE**
TLED-GL12SG: **GREEN**
TLED-GL12SP: **PURPLE**
TLED-GL12SR: **RED**
TLED-GL12SW: **WHITE**

24 INCH

TLED-GL24SA: **AMBER**
TLED-GL24SB: **BLUE**
TLED-GL24SG: **GREEN**
TLED-GL24SP: **PURPLE**
TLED-GL24SR: **RED**
TLED-GL24SW: **WHITE**

48 INCH

TLED-GL48SA: **AMBER**
TLED-GL48SB: **BLUE**
TLED-GL48SG: **GREEN**
TLED-GL48SP: **PURPLE**
TLED-GL48SR: **RED**
TLED-GL48SW: **WHITE**



SEE PAGES 107-109 FOR MORE INFORMATION

LED LIGHTING

12" CENTER GLOW STRIP - 60 LEDS AUXILIARY



▲ AMBER AUXILIARY
TLED-GL12CA



▲ BLUE AUXILIARY
TLED-GL12CB



▲ GREEN AUXILIARY
TLED-GL12CG



▲ PURPLE AUXILIARY
TLED-GL12CP



▲ RED AUXILIARY
TLED-GL12CR



▲ WHITE AUXILIARY
TLED-GL12CW

TECHNICAL SPECIFICATIONS

DIODES	60 Diodes
AUXILIARY	TLED-GL12CA, TLED-GL12CB, TLED-GL12CG, TLED-GL12CP, TLED-GL12CR, TLED-GL12CW
WHAT'S INCLUDED	3M Tape (Double Sided)
CURRENT DRAW	0.11 Amps ~ 0.22 Amps
LENS MATERIAL	Polycarbonate
WARRANTY	3 Years

ACCESSORY OPTIONS

WIRE HARNESS (pg. 117)	D Series
------------------------	----------

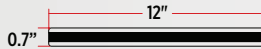

WIRING

2 BULLET PLUGS



Link Glow Strips together regardless of size.
Assemble with any Double Female Wire Harness.



12" SIDE GLOW STRIP - 60 LEDS AUXILIARY



▲ AMBER AUXILIARY
TLED-GL12SA



▲ BLUE AUXILIARY
TLED-GL12SB



▲ GREEN AUXILIARY
TLED-GL12SG



▲ PURPLE AUXILIARY
TLED-GL12SP



▲ RED AUXILIARY
TLED-GL12SR



▲ WHITE AUXILIARY
TLED-GL12SW

TECHNICAL SPECIFICATIONS

DIODES	60 Diodes
AUXILIARY	TLED-GL12SA, TLED-GL12SB, TLED-GL12SG, TLED-GL12SP, TLED-GL12SR, TLED-GL12SW
WHAT'S INCLUDED	3M Tape (Double Sided)
CURRENT DRAW	0.1 Amps ~ 0.21 Amps
LENS MATERIAL	Polycarbonate
WARRANTY	3 Years

ACCESSORY OPTIONS

WIRE HARNESS (pg. 117)	D Series
------------------------	----------

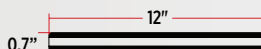

WIRING

2 BULLET PLUGS



Link Glow Strips together regardless of size.
Assemble with any Double Female Wire Harness.



24" CENTER GLOW STRIP - 120 LEDS AUXILIARY



▲ AMBER AUXILIARY
TLED-GL24CA



▲ BLUE AUXILIARY
TLED-GL24CB



▲ GREEN AUXILIARY
TLED-GL24CG



▲ PURPLE AUXILIARY
TLED-GL24CP

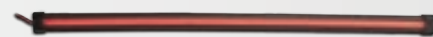

▲ RED AUXILIARY
TLED-GL24CR



▲ WHITE AUXILIARY
TLED-GL24CW

TECHNICAL SPECIFICATIONS

DIODES	120 Diodes
AUXILIARY	TLED-GL24CA, TLED-GL24CB, TLED-GL24CG, TLED-GL24CP, TLED-GL24CR, TLED-GL24CW
WHAT'S INCLUDED	3M Tape (Double Sided)
CURRENT DRAW	0.94 Amps ~ 0.95 Amps
LENS MATERIAL	Polycarbonate
WARRANTY	3 Years

ACCESSORY OPTIONS

WIRE HARNESS (pg. 117) D Series

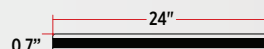

WIRING

2 BULLET PLUGS



Link Glow Strips together regardless of size.
Assemble with any Double Female Wire Harness.



24" SIDE GLOW STRIP - 120 LEDS AUXILIARY



▲ AMBER AUXILIARY
TLED-GL24SA



▲ BLUE AUXILIARY
TLED-GL24SB



▲ GREEN AUXILIARY
TLED-GL24SG



▲ PURPLE AUXILIARY
TLED-GL24SP



▲ RED AUXILIARY
TLED-GL24SR



▲ WHITE AUXILIARY
TLED-GL24SW

TECHNICAL SPECIFICATIONS

DIODES	120 Diodes
AUXILIARY	TLED-GL24SA, TLED-GL24SB, TLED-GL24SG, TLED-GL24SP, TLED-GL24SR, TLED-GL24SW
WHAT'S INCLUDED	3M Tape (Double Sided)
CURRENT DRAW	77 Amps ~ 1.07 Amps
LENS MATERIAL	Polycarbonate
WARRANTY	3 Years

ACCESSORY OPTIONS

WIRE HARNESS (pg. 117) D Series

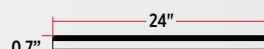

WIRING

2 BULLET PLUGS



Link Glow Strips together regardless of size.
Assemble with any Double Female Wire Harness.



LED LIGHTING

48" CENTER GLOW STRIP - 240 LEDS AUXILIARY



▲ AMBER AUXILIARY
TLED-GL48CA



▲ BLUE AUXILIARY
TLED-GL48CB



▲ GREEN AUXILIARY
TLED-GL48CG



▲ PURPLE AUXILIARY
TLED-GL48CP



▲ RED AUXILIARY
TLED-GL48CR



▲ WHITE AUXILIARY
TLED-GL48CW

TECHNICAL SPECIFICATIONS

DIODES	240 Diodes
AUXILIARY	TLED-GL48CA, TLED-GL48CB, TLED-GL48CG, TLED-GL48CP, TLED-GL48CR, TLED-GL48CW
WHAT'S INCLUDED	3M Tape (Double Sided)
CURRENT DRAW	1.29 Amps ~ 1.78 Amps
LENS MATERIAL	Polycarbonate
WARRANTY	3 Years

ACCESSORY OPTIONS

WIRE HARNESS (pg. 117)	D Series
------------------------	----------



WIRING

2 BULLET PLUGS



Link Glow Strips together regardless of size.
Assemble with any Double Female Wire Harness.



48" SIDE GLOW STRIP - 240 LEDS AUXILIARY



▲ AMBER AUXILIARY
TLED-GL48SA



▲ BLUE AUXILIARY
TLED-GL48SB



▲ GREEN AUXILIARY
TLED-GL48SG



▲ PURPLE AUXILIARY
TLED-GL48SP



▲ RED AUXILIARY
TLED-GL48SR



▲ WHITE AUXILIARY
TLED-GL48SW

TECHNICAL SPECIFICATIONS

DIODES	240 Diodes
AUXILIARY	TLED-GL48SA, TLED-GL48SB, TLED-GL48SG, TLED-GL48SP, TLED-GL48SR, TLED-GL48SW
WHAT'S INCLUDED	3M Tape (Double Sided)
CURRENT DRAW	1.06 Amps ~ 1.79 Amps
LENS MATERIAL	Polycarbonate
WARRANTY	3 Years

ACCESSORY OPTIONS

WIRE HARNESS (pg. 117)	D Series
------------------------	----------



WIRING

2 BULLET PLUGS



Link Glow Strips together regardless of size.
Assemble with any Double Female Wire Harness.



⚠ WARNING: Cancer and Reproductive Harm - www.p65warnings.ca.gov

0.5 X 17" UNDERMOUNT - 24 LEDS AUXILIARY



▲
AMBER AUXILIARY
TLED-SA





▲
RED AUXILIARY
TLED-SR

TECHNICAL SPECIFICATIONS

DIODES	24 Diodes
AUXILIARY	TLED-SA, TLED-SR
WHAT'S INCLUDED	3M Tape (Double Sided)
CURRENT DRAW	13 mA
LENS MATERIAL	Polycarbonate
WARRANTY	3 Years

ACCESSORY OPTIONS

WIRE HARNESS (pg. 117)	D Series
 CASE QTY. 100 PCS	 0.5" 17" INSTALLS WITH 3M TAPE & HARDWARE - INCLUDED
 INNER BOX QTY. 10 PCS	

WIRING

2 BULLET PLUGS



Assemble with any Double Female Wire Harness.

16 FT. FLEXIBLE ROLL - 18 LEDS PER FT. AUXILIARY



▲
AMBER AUXILIARY
TB-F2A



▲
BLUE AUXILIARY
TB-F2B



▲
GREEN AUXILIARY
TB-F2G



▲
RED AUXILIARY
TB-F2R



▲
WHITE AUXILIARY
TB-F2W

TECHNICAL SPECIFICATIONS

DIODES	18 Diodes per Foot
AUXILIARY	TB-F2A, TB-F2B, TB-F2G, TB-F2R, TB-F2W
OPERATING VOLTAGE	12 Volts
CURRENT DRAW	3 mA
LENS MATERIAL	Polycarbonate
WARRANTY	3 Years

➤ The Flexible Roll is designed for customized use. It can be cut every 3 diodes to your desired length.



FLEXIBLE ROLL ACCESSORIES

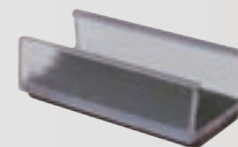

▲
CLEAR TUBE CLIP WITH DOUBLE SIDED 3M TAPE
TB-FCLIP

TECHNICAL SPECIFICATIONS

SOLD	Individually
------	--------------

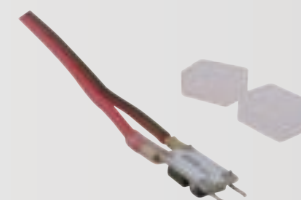

▲
FLEXIBLE LED ROLL INSTALLATION KIT
TB-FKIT

TECHNICAL SPECIFICATIONS

WHAT'S INCLUDED	2 End Caps & Duplex Wire Lead
SOLD	Individually

LED LIGHTING

1156 REPLACEMENT BULBS HIGH



▲ AMBER REPLACEMENT
TB-S1156A

▲ RED REPLACEMENT
TB-S1156R

▲ WHITE REPLACEMENT
TB-S1156W

TECHNICAL SPECIFICATIONS

DIODES	13 Diodes
FUNCTION	High
CURRENT DRAW	50 mA
LENS MATERIAL	Polycarbonate



CASE QTY.
250 PCS



INNER BOX QTY.
50 PCS

1157 REPLACEMENT BULBS HIGH & LOW



▲ AMBER REPLACEMENT
TB-S1157A

▲ RED REPLACEMENT
TB-S1157R

▲ WHITE REPLACEMENT
TB-S1157W

TECHNICAL SPECIFICATIONS

DIODES	13 Diodes
FUNCTION	High & Low
CURRENT DRAW	50 mA
LENS MATERIAL	Polycarbonate



CASE QTY.
250 PCS



INNER BOX QTY.
50 PCS

3156 REPLACEMENT BULBS HIGH



▲ AMBER REPLACEMENT
TB-SP3156A

▲ RED REPLACEMENT
TB-SP3156R

▲ WHITE REPLACEMENT
TB-SP3156R

TECHNICAL SPECIFICATIONS

DIODES	13 Diodes
FUNCTION	High
CURRENT DRAW	50 mA
LENS MATERIAL	Polycarbonate



CASE QTY.
250 PCS



INNER BOX QTY.
50 PCS

3157 REPLACEMENT BULBS HIGH & LOW



▲ AMBER REPLACEMENT
TB-SP3157A

▲ RED REPLACEMENT
TB-SP3157R

▲ WHITE REPLACEMENT
TB-SP3157W

TECHNICAL SPECIFICATIONS

DIODES	13 Diodes
FUNCTION	High & Low
CURRENT DRAW	50 mA
LENS MATERIAL	Polycarbonate



CASE QTY.
250 PCS



INNER BOX QTY.
50 PCS

194 REPLACEMENT BULBS WITH LENS

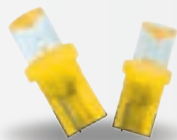

▲
AMBER REPLACEMENT
TB-SP3037A



▲
RED REPLACEMENT
TB-SP3037R



▲
WHITE REPLACEMENT
TB-SP3037W

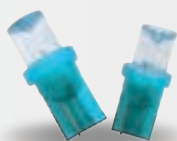

▲
BLUE REPLACEMENT
TB-SP3037B



▲
GREEN REPLACEMENT
TB-SP3037G

TECHNICAL SPECIFICATIONS

DIODES	1 Diode
REPLACEMENT	194 Replacement
CURRENT DRAW	10 mA
LENS MATERIAL	Polycarbonate



CASE QTY.
500 PCS



INNER BOX QTY.
100 PCS
2 PER PACK

LED STROBE FLASHER 3 PULSE STROBE



▲
3 PLUSE STROBE
TU-1007

TECHNICAL SPECIFICATIONS

FUNCTION	3 Pulse Strobe
SOLD	Individually
INSTALLATION	Connect the LED Strobe Adapter to your LED Wiring to achieve the Strobe effect.

UTILITY & LICENSE - 3 LEDS AUXILIARY



▲
WHITE AUXILIARY
TB-C7W

TECHNICAL SPECIFICATIONS

DIODES	3 Diodes
FUNCTION	Auxiliary
CURRENT DRAW	38 mA
LENS MATERIAL	Polycarbonate
WARRANTY	3 Years



CASE QTY.
200 PCS



INNER BOX QTY.
10 PCS

WIRING

2 WIRES

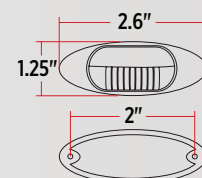

LIGHTING ACCESSORIES

LOCK ON ROUND BEZEL

2"



▲
2" ROUND
TBEZ-2CH4



▲
2" ROUND WITH VISOR
TBEZ-2CH5

2.5"



▲
2.5" ROUND
TBEZ-2HCH4



▲
2.5" ROUND WITH VISOR
TBEZ-2HCH5

4"



▲
4" ROUND
TBEZ-4CH4



▲
4" ROUND WITH VISOR
TBEZ-4CH5

LOCK ON TECHNICAL SPECIFICATIONS

MATERIAL	Chrome ABS Plastic
SOLD	Individually
CASE QUANTITY	200 PCS

LOCK ON TECHNOLOGY

The 4 special tabs attached behind the bezel, grip under the grommet and lock once you twist adequately.
EASY & QUICK INSTALLATION!



SCREW ON ROUND BEZEL

2"



▲
2" ROUND
TBEZ-2CH3



▲
2" ROUND WITH VISOR
TBEZ-2CH2

2.5"



▲
2.5" ROUND
TBEZ-2HCH3



▲
2.5" ROUND WITH VISOR
TBEZ-2HCH2

4"



▲
4" ROUND
TBEZ-4CH3



▲
4" ROUND WITH VISOR
TBEZ-4CH2

SCREW ON TECHNICAL SPECIFICATIONS

MATERIAL	Chrome ABS Plastic
SOLD	Individually
CASE QUANTITY / INNER BOX QUANTITY	100 PCS: TBEZ-4CH2 150 PCS: TBEZ-2HCH2 200 PCS: TBEZ-2CH2, TBEZ-4CH3 400 PCS / 100 PCS: TBEZ-2CH3 500 PCS: TBEZ-2HCH3

LOCK ON
OVAL BEZEL



▲
OVAL
TBEZ-OBCH4



▲
OVAL WITH VISOR
TBEZ-OBCH5

TECHNICAL SPECIFICATIONS

MATERIAL	Chrome ABS Plastic
SOLD	Individually
CASE QUANTITY	200 PCS

LOCK ON TECHNOLOGY

The 4 special tabs attached behind the bezel, grip under the grommet and lock once you twist adequately.

EASY & QUICK INSTALLATION!



SCREW ON
OVAL BEZEL



OVAL
TBEZ-OBCH3



▲
OVAL WITH VISOR
TBEZ-OBCH2

TECHNICAL SPECIFICATIONS

MATERIAL	Chrome ABS Plastic
SOLD	Individually
CASE QUANTITY / INNER BOX QUANTITY	100 PCS: TBEZ-OBCH2 200 PCS / 100 PCS: TBEZ-OBCH3

HEADLIGHT
ASSEMBLY BEZEL



▲
UNIVERSAL HEADLIGHT ASSEMBLY
TU-1043

TECHNICAL SPECIFICATIONS

MATERIAL	Chrome ABS Plastic
SOLD	Individually
CASE QUANTITY	20 PCS

SECURITY LOCK RING
ROUND | OVAL



▲
4" ROUND
TBEZ-4LR



▲
OVAL
TBEZ-OLR

TECHNICAL SPECIFICATIONS

MATERIAL	Chrome ABS Plastic
SOLD	Individually
CASE QUANTITY / INNER BOX QUANTITY	100 PCS/ 20 PCS

LIGHTING ACCESSORIES

GROMMETS ROUND

2"



▲
2" ROUND OPEN BACK
TGRO-2R

▲
2" ROUND CLOSED BACK
TGRO-2RC

2.5"



▲
2.5" ROUND OPEN BACK
TGRO-2HRO

▲
2.5" ROUND CLOSED BACK
TGRO-2HR

4"



▲
4" ROUND OPEN BACK
TGRO-4R

▲
4" ROUND CLOSED BACK
TGRO-4RC

TECHNICAL SPECIFICATIONS

MATERIAL	Rubber
SOLD	Individually
CASE QUANTITY / INNER BOX QUANTITY	100 PCS: TGRO-4R, TGRO-4RC 200 PCS: TGRO-2RC, TGRO-2HR 400 PCS / 50 PCS: TGRO-2R, TGRO-2HRO

GROMMETS OVAL



▲
OVAL OPEN BACK
TGRO-OBR

▲
OVAL CLOSED BACK
TGRO-OBRC

TECHNICAL SPECIFICATIONS

MATERIAL	Rubber
SOLD	Individually
CASE QUANTITY	200 PCS: TGRO-OBR 100 PCS: TGRO-OBRC

GROMMETS SQUARE



▲
SQUARE OPEN BACK
TGRO-SQR

TECHNICAL SPECIFICATIONS

MATERIAL	Rubber
SOLD	Individually
CASE QUANTITY	50 PC

SCREW ON SQUARE



▲
SQUARE WITH VISOR
TBEZ-SQR

TECHNICAL SPECIFICATIONS

MATERIAL	Chome ABS Plastic
SOLD	Individually
CASE QUANTITY	80 PCS

THE DIFFERENCE!

Choosing either an Open Back or Closed back grommet is based on the protection and location of your LED light. If you are installing an LED light that is closer to the road surface, then the Closed Back Grommet is the advisable choice, due to its extra protection against all weather elements. The LED wiring can be passed through the hole or slit of the closed back grommet to allow maximum protection of the LED.

▲ WARNING: Cancer and Reproductive Harm - www.p65warnings.ca.gov

CONVERSION PLUGS 3 PRONG PIGTAIL



▲ SUPERSEAL TO 3 PRONG PIGTAIL
TPIG-L1



▲ LOCK CONNECTOR TO 3 PRONG PIGTAIL
TPIG-L2

TECHNICAL SPECIFICATIONS

PART NUMBER	TPIG-L1	TPIG-L2
CONNECTOR TYPE	Super Seal	Lock Connector
FUNCTION	3 Prong Conversion	3 Prong Conversion
SOLD	Individually	Individually

PIGTAILS INDIVIDUAL WIRE



▲ 2 PRONG
TPIG-2W



▲ 3 PRONG
TPIG-3W

TECHNICAL SPECIFICATIONS

PART NUMBER	TPIG-2W	TPIG-3W
CONNECTOR TYPE	2 Prong Male	3 Prong Male
SOLD	Individually	Individually

2 OR 3 PRONG?

Always check the connection requirements for the LED Light before purchasing the corresponding Pigtail.

LOAD RESISTORS LED LIGHTING | LED HEADLIGHTS



▲ 21 WATTS
TU-1005

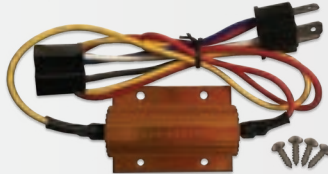

▲ 80 WATTS
TU-1039

TECHNICAL SPECIFICATIONS

PART NUMBER	TU-1005	TU-1039
CURRENT DRAW	21 Watts	80 Watts
COMPATABILITY	LED Lighting	LED Headlights
WHAT'S INCLUDED	N/A	4 Screws
SOLD	Individually	Individually

H4 CONNECTOR EXTENSION PLUG - LED HEADLIGHTS



▲ H4 HEADLIGHT CONNECTOR EXTENSION PLUG
TPIG-H1

TECHNICAL SPECIFICATIONS

CONNECTOR TYPE	H4 (Female)
SOLD	Individually

THE PURPOSE

Load Resistors are used for trucks that are not LED compatible. Connecting a load resistor will compensate the low power wattage of LEDs.

LIGHTING ACCESSORIES

FEMALE WIRE HARNESS Single SERIES



▲
100 FT. SPOOL
S608 | S610 | S612

TECHNICAL SPECIFICATIONS

PART NUMBER	S608	S610	S612
CONNECTOR TYPE	Single Terminal	Single Terminal	Single Terminal
CONNECTOR SPACING	8" Spacing	10" Spacing	12" Spacing
TOTAL PLUGS	131 Plugs	110 Plugs	92 Plugs
SOLD	100 ft. Spool	100 ft. Spool	100 ft. Spool

WIRING

Single FEMALE PIGTAIL



FEMALE WIRE HARNESS DOUBLE SERIES



▲
100 FT. SPOOL
D604 | D606 | D608 | D610 | D612

TECHNICAL SPECIFICATIONS

PART NUMBER	D604	D606	D608	D610	D612
CONNECTOR TYPE	Double Terminal	Double Terminal	Double Terminal	Double Terminal	Double Terminal
CONNECTOR SPACING	4" Spacing	6" Spacing	8" Spacing	10" Spacing	12" Spacing
TOTAL PLUGS	234 Plugs	168 Plugs	131 Plugs	110 Plugs	92 Plugs
SOLD	100 ft. Spool	100 ft. Spool	100 ft. Spool	100 ft. Spool	100 ft. Spool

WIRING

DOUBLE FEMALE PIGTAIL



▲ WARNING: Cancer and Reproductive Harm - www.p65warnings.ca.gov

FEMALE WIRE HARNESS

TRIPLE SERIES



100 FT. SPOOL
T604 | T606 | T608 | T610 | T612

TECHNICAL SPECIFICATIONS

PART NUMBER	T604	T606	T608	T610	T612
CONNECTOR TYPE	Triple Terminal	Triple Terminal	Triple Terminal	Triple Terminal	Triple Terminal
CONNECTOR SPACING	4" Spacing	6" Spacing	8" Spacing	10" Spacing	12" Spacing
TOTAL PLUGS	220 Plugs	150 Plugs	131 Plugs	110 Plugs	92 Plugs
SOLD	100 ft. Spool	100 ft. Spool	100 ft. Spool	100 ft. Spool	100 ft. Spool

WIRING

TRIPLE FEMALE PIGTAIL



MALE WIRE HARNESS

2 PRONG | 3 PRONG



100 FT. SPOOL
B607 | B608 | B609 | B610 | B611



100 FT. SPOOL
B612

TECHNICAL SPECIFICATIONS

PART NUMBER	B607	B608	B609	B610	B611	B612
CONNECTOR TYPE	2 Prong Male	2 Prong Male	2 Prong Male	2 Prong Male	2 Prong Male	3 Prong Male
CONNECTOR SPACING	4" Spacing	6" Spacing	8" Spacing	10" Spacing	12" Spacing	12" Spacing
TOTAL PLUGS	234 Plugs	168 Plugs	131 Plugs	110 Plugs	92 Plugs	92 Plugs
SOLD	100 ft. Spool	100 ft. Spool	100 ft. Spool	100 ft. Spool	100 ft. Spool	100 ft. Spool

WIRING

2 PRONG MALE PLUG



3 PRONG MALE PLUG



UNIVERSAL ACCESSORIES

THREADED WHEEL ACCESSORY KIT DOME HUBCAPS - CHROME ABS PLASTIC

**TOP
SELLER**



WITH 33MM THREADED NUT COVERS

THUB-C1

TECHNICAL SPECIFICATIONS

KIT INCLUDES	2 x Chrome ABS Plastic Front Axle Covers with Removable Dome Hubcap 4 x Chrome ABS Plastic Rear Axle Covers with Removable Dome Hubcap 60 x Chrome ABS Plastic 33mm Threaded Nut Covers 1 x Nut Cover Tool
--------------	----------------------------------------------------------------------------------------------------------------------------------------------------------------------------------------------------------------------------

COMPLETE ALL-IN-ONE KIT OUTFITS THE WHOLE TRUCK

FEATURES & BENEFITS

- **Threaded Nut Cover Installation**
- **Rust Resistant**
- **Removable** Front and Rear Hubcap to Access Axle
- **Designed to Fit**
 - Most 11 1/4" Bolt Circle/Center Applications
 - Most 20", 22.5" & 24.5" Wheels
 - 3 or 4 Exposed Thread (For Threaded Nut Covers)

BOX DIMENSIONS	27.25" x 15.25" x 14.5"
SOLD	As a Kit
WARRANTY	1 Year



CASE QTY.
2 PCS

THREADED WHEEL ACCESSORY KIT POINTED - CHROME ABS PLASTIC



WITH 33MM THREADED POINTED NUT COVERS

THUB-C4

TECHNICAL SPECIFICATIONS

KIT INCLUDES	2 x Chrome ABS Plastic Pointed Front Axle Covers with Removable Pointed Hubcap 4 x Chrome ABS Plastic Pointed Rear Axle Covers with Removable Pointed Hubcap 60 x Chrome ABS Plastic Pointed 33mm Threaded Nut Covers 1 x Nut Cover Tool
--------------	----------------------------------------------------------------------------------------------------------------------------------------------------------------------------------------------------------------------------------------------------------

COMPLETE ALL-IN-ONE KIT OUTFITS THE WHOLE TRUCK

FEATURES & BENEFITS

- **Threaded Pointed Nut Cover Installation**
- **Rust Resistant**
- **Removable** Front and Rear Hubcap to Access Axle
- **Designed to Fit**
 - Most 11 1/4" Bolt Circle/Center Applications
 - Most 20", 22.5" & 24.5" Wheels
 - 3 or 4 Exposed Thread (For Threaded Nut Covers)

BOX DIMENSIONS	26.5" x 14" x 14"
SOLD	As a Kit
WARRANTY	1 Year



CASE QTY.
2 PCS

WARNING: Cancer and Reproductive Harm - www.p65warnings.ca.gov

PUSH ON WHEEL ACCESSORY KIT

DOME HUBCAPS - CHROME ABS PLASTIC



COMPLETE ALL-IN-ONE KIT OUTFITS THE WHOLE TRUCK

FEATURES & BENEFITS

- Push On Nut Cover Installation
- Rust Resistant
- Removable Front and Rear Hubcap to Access Axle
- Designed to Fit
 - Most 11 1/4" Bolt Circle/Center Applications
 - Most 20", 22.5" & 24.5" Wheels

WITH 33MM PUSH ON NUT COVERS
THUB-C7

TECHNICAL SPECIFICATIONS

KIT INCLUDES	2 x Chrome ABS Plastic Front Axle Covers with Removable Dome Hubcap 4 x Chrome ABS Plastic Rear Axle Covers with Removable Dome Hubcap 60 x Chrome ABS Plastic 33mm Push On Nut Covers
--------------	-----------------------------------------------------------------------------------------------------------------------------------------------------------------------------------------------------

BOX DIMENSIONS	26.5" x 14" x 14"
SOLD	As a Kit
WARRANTY	1 Year



WARNING: Cancer and Reproductive Harm - www.p65warnings.ca.gov

UNIVERSAL ACCESSORIES

DOME HUB COVER WHEEL ACCESSORY KITS CHROME METAL | STAINLESS STEEL

**TOP
SELLER**



▲
CHROME METAL
THUB-C2

COMPLETE ALL-IN-ONE KIT OUTFITS THE WHOLE TRUCK

- Push On Nut Cover Installation
- Designed to Fit
 - Most 11 1/4" Bolt Circle/Center Applications
 - Most 20", 22.5" & 24.5" Wheels

TECHNICAL SPECIFICATIONS

KIT INCLUDES	2 x Chrome Metal 6 Uneven Notch Front Dome Hubcaps (Fits 6, 5 & 4 Notches) 4 x Chrome Metal 8" I.D Rear Hubcaps 60 x Chrome ABS Plastic 33mm Push On Nut Covers
--------------	-----------------------------------------------------------------------------------------------------------------------------------------------------------------------

BOX DIMENSIONS	13.75" x 9.8" x 9.8"
SOLD	As a Kit
WARRANTY	1 Year



CASE QTY.
8 PCS

**TOP
SELLER**



▲
STAINLESS STEEL
THUB-C3

COMPLETE ALL-IN-ONE KIT OUTFITS THE WHOLE TRUCK

- Push On Nut Cover Installation
- Designed to Fit
 - Most 11 1/4" Bolt Circle/Center Applications
 - Most 20", 22.5" & 24.5" Wheels

TECHNICAL SPECIFICATIONS

KIT INCLUDES	2 x Stainless Steel 6 Uneven Notch Front Dome Hubcaps (Fits 6, 5 & 4 Notches) 4 x Stainless Steel 8" I.D Rear Hubcaps 60 x Chrome ABS Plastic 33mm Push On Nut Covers
--------------	-----------------------------------------------------------------------------------------------------------------------------------------------------------------------------

BOX DIMENSIONS	13.75" x 9.8" x 9.8"
SOLD	As a Kit
WARRANTY	1 Year



CASE QTY.
8 PCS



⚠ WARNING: Cancer and Reproductive Harm - www.p65warnings.ca.gov

DOMI TRAILER WHEEL ACCESSORY KITS

CHROME METAL | STAINLESS STEEL

NEW



▲ CHROME METAL
THUB-C5

COMPLETE ALL-IN-ONE KIT OUTFITS THE WHOLE TRAILER

- Push On Nut Cover Installation
- Designed to Fit
Trailers with Hub Pilot Wheels 22.5" or 24"

TECHNICAL SPECIFICATIONS

KIT INCLUDES	4 x Chrome Metal Trailer Dome Hubcaps 4 x Stainless Steel Trailer Brackets 40 x Chrome ABS Plastic 33mm Push On Nut Covers
--------------	----------------------------------------------------------------------------------------------------------------------------------

BOX DIMENSIONS	13.75" x 9.8" x 9.8"
SOLD	As a Kit
WARRANTY	1 Year



NEW



▲ STAINLESS STEEL
THUB-C6

COMPLETE ALL-IN-ONE KIT OUTFITS THE WHOLE TRAILER

- Push On Nut Cover Installation
- Designed to Fit
Trailers with Hub Pilot Wheels 22.5" or 24"

TECHNICAL SPECIFICATIONS

KIT INCLUDES	4 x Stainless Steel Trailer Dome Hubcaps 4 x Stainless Steel Trailer Brackets 40 x Chrome ABS Plastic 33mm Push On Nut Covers
--------------	-------------------------------------------------------------------------------------------------------------------------------------

BOX DIMENSIONS	13.75" x 9.8" x 9.8"
SOLD	As a Kit
WARRANTY	1 Year



⚠ WARNING: Cancer and Reproductive Harm - www.p65warnings.ca.gov

UNIVERSAL ACCESSORIES

FRONT AXLE COVER KITS DOME HUBCAP - CHROME ABS PLASTIC

**TOP
SELLER**



WITH 33MM THREADED NUT COVERS

THUB-FRP33

- Threaded Nut Cover Installation
- Rust Resistant
- Removable Front Hubcap to Access Axle
- Designed to Fit

Most 11 1/4" Bolt Circle/Center Applications
Most 20", 22.5" & 24.5" Wheels
3 or 4 Exposed Thread (For Threaded Nut Covers)

TECHNICAL SPECIFICATIONS

KIT INCLUDES	1 x Chrome ABS Plastic Front Axle Cover with Removable Dome Hubcap 10 x Chrome ABS Plastic 33mm Threaded Nut Covers
BOX DIMENSIONS	14.25" x 4.25" x 14.25"
SOLD	As a Kit
WARRANTY	1 Year



CASE QTY.
10 PCS



WITH 33MM PUSH ON NUT COVERS

THUB-FRP33PO

- Push On Nut Cover Installation
- Rust Resistant
- Removable Front Hubcap to Access Axle
- Designed to Fit

Most 11 1/4" Bolt Circle/Center Applications
Most 20", 22.5" & 24.5" Wheels

TECHNICAL SPECIFICATIONS

KIT INCLUDES	1 x Chrome ABS Plastic Front Axle Cover with Removable Dome Hubcap 10 x Chrome ABS Plastic 33mm Push On Nut Covers
BOX DIMENSIONS	14.25" x 4.25" x 14.25"
SOLD	As a Kit
WARRANTY	1 Year



CASE QTY.
10 PCS



WARNING: Cancer and Reproductive Harm - www.p65warnings.ca.gov

FRONT AXLE COVER KITS DOME HUBCAP - CHROME ABS PLASTIC



WITH BLACK 33MM THREADED NUT COVERS

THUB-FRP33B

- Threaded Nut Cover Installation
- Rust Resistant
- Removable Front Hubcap to Access Axle
- Designed to Fit
 - Most 11 1/4" Bolt Circle/Center Applications
 - Most 20", 22.5" & 24.5" Wheels
 - 3 or 4 Exposed Thread (For Threaded Nut Covers)

TECHNICAL SPECIFICATIONS

KIT INCLUDES	1 x Chrome ABS Plastic Black Front Axle Cover with Removable Dome Hubcap 10 x Chrome ABS Plastic Black 33mm Threaded Nut Covers
--------------	------------------------------------------------------------------------------------------------------------------------------------

BOX DIMENSIONS	14.25" x 4.25" x 14.25"
SOLD	As a Kit
WARRANTY	1 Year



CASE QTY.
10 PCS

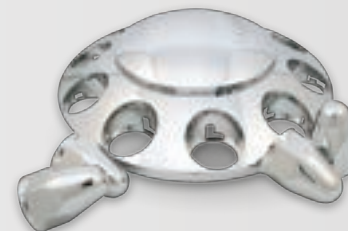

WITH 1 1/2" PUSH ON NUT COVERS

THUB-FRP112

- 1 1/2" Push On Nut Cover Installation
- Rust Resistant
- Removable Front Hubcap to Access Axle
- Designed to Fit
 - Most 11 1/4" Bolt Circle/Center Applications
 - Most 20", 22.5" & 24.5" Wheels

TECHNICAL SPECIFICATIONS

KIT INCLUDES	1 x Chrome ABS Plastic Front Axle Cover with Removable Dome Hubcap 10 x Chrome ABS Plastic 1 1/2" Push On Nut Covers 2 x Locking Rings
--------------	----------------------------------------------------------------------------------------------------------------------------------------------

BOX DIMENSIONS	14.25" x 4.25" x 14.25"
SOLD	As a Kit
WARRANTY	1 Year



CASE QTY.
10 PCS

FRONT AXLE ACCESSORIES FRONT AXLE COVER | DOME HUBCAP - CHROME ABS PLASTIC



FRONT AXLE COVER WITH REPLACEMENT DOME HUBCAP
THUB-FRPN Nut Covers NOT Included

- Rust Resistant
- Removable Front Hubcap to Access Axle
- Designed to Fit
 - Most 11 1/4" Bolt Circle/Center Applications
 - Most 20", 22.5" & 24.5" Wheels

TECHNICAL SPECIFICATIONS

BOX DIMENSIONS	14" x 4" x 14"
SOLD	Individually
WARRANTY	1 Year



CASE QTY.
10 PCS



FRONT AXLE COVER REPLACEMENT DOME HUBCAP
THUB-FRP

- Rust Resistant
- Designed to Fit
 - Most 11 1/4" Bolt Circle/Center Applications
 - Front Axle Kits: THUB-FRP33, THUB-FRP33PO, THUB-FRP112 & THUB-FRPN

TECHNICAL SPECIFICATIONS

SOLD	Individually
WARRANTY	1 Year



CASE QTY.
80 PCS

UNIVERSAL ACCESSORIES

POINTED FRONT AXLE COVER KIT CHROME ABS PLASTIC



WITH 33MM THREADED POINTED NUT COVERS
THUB-FRP33P

- Threaded Pointed Nut Cover Installation
- Rust Resistant
- Removable Front Hubcap to Access Axle
- Designed to Fit
 - Most 11 1/4" Bolt Circle/Center Applications
 - Most 20", 22.5" & 24.5" Wheels

TECHNICAL SPECIFICATIONS

KIT INCLUDES	1 x Chrome ABS Plastic Pointed Front Axle Cover with Removable Pointed Hubcap 10 x Chrome ABS Plastic 33mm Threaded Pointed Nut Covers
BOX DIMENSIONS	14.25" x 4.25" x 14.25"
SOLD	As a Kit
WARRANTY	1 Year



CASE QTY.
10 PCS

POINTED FRONT AXLE COVER CHROME ABS PLASTIC



POINTED FRONT AXLE COVER
THUB-FRPNP Nut Covers NOT Included

- Rust Resistant
- Removable Front Hubcap to Access Axle
- Designed to Fit
 - Most 11 1/4" Bolt Circle/Center Applications
 - Most 20", 22.5" & 24.5" Wheels

TECHNICAL SPECIFICATIONS

KIT INCLUDES	1 x Chrome ABS Plastic Pointed Front Axle Cover with Removable Pointed Hubcap
BOX DIMENSIONS	14.25" x 4.25" x 14.25"
SOLD	Individually
WARRANTY	1 Year



CASE QTY.
10 PCS



WARNING: Cancer and Reproductive Harm - www.p65warnings.ca.gov

REAR AXLE COVER KITS

DOMED HUBCAP - CHROME ABS PLASTIC

TOP SELLER



WITH 33MM THREADED NUT COVERS
THUB-RP33 Threaded Nut Covers

- Threaded Nut Cover Installation
- Rust Resistant
- Removable Rear Hubcap to Access Axle
- Designed to Fit
 - Most 11 1/4" Bolt Circle/Center Applications
 - Most 20", 22.5" & 24.5" Wheels
 - 3 or 4 Exposed Thread (For Threaded Nut Covers)

TECHNICAL SPECIFICATIONS

KIT INCLUDES	1 x Chrome ABS Plastic Rear Axle Cover with Removable Dome Hubcap 10 x Chrome ABS Plastic 33mm Threaded Nut Covers
BOX DIMENSIONS	36" x 14.5" x 15"
SOLD	As a Kit
WARRANTY	1 Year



WITH 33MM PUSH ON NUT COVERS
THUB-RP33PO Push On Nut Covers

- Push On Nut Cover Installation
- Rust Resistant
- Removable Rear Hubcap to Access Axle
- Designed to Fit
 - Most 11 1/4" Bolt Circle/Center Applications
 - Most 20", 22.5" & 24.5" Wheels

TECHNICAL SPECIFICATIONS

KIT INCLUDES	1 x Chrome ABS Plastic Rear Axle Cover with Removable Dome Hubcap 10 x Chrome ABS Plastic 33mm Push On Nut Covers
BOX DIMENSIONS	36" x 14.5" x 15"
SOLD	As a Kit
WARRANTY	1 Year



WARNING: Cancer and Reproductive Harm - www.p65warnings.ca.gov

UNIVERSAL ACCESSORIES

REAR AXLE COVER KITS DOME HUBCAP - CHROME ABS PLASTIC



WITH BLACK 33MM THREADED NUT COVERS
THUB-RP33B

- Threaded Nut Cover Installation
- Rust Resistant
- Removable Rear Hubcap to Access Axle
- Designed to Fit
 - Most 11 1/4" Bolt Circle/Center Applications
 - Most 20", 22.5" & 24.5" Wheels
 - 3 or 4 Exposed Thread (For Threaded Nut Covers)

TECHNICAL SPECIFICATIONS

KIT INCLUDES	1 x Chrome ABS Plastic Black Rear Axle Cover with Removable Dome Hubcap 10 x Chrome ABS Plastic Black 33mm Threaded Nut Covers
--------------	-----------------------------------------------------------------------------------------------------------------------------------

BOX DIMENSIONS	36" x 14.5" x 15"
SOLD	As a Kit
WARRANTY	1 Year



CASE QTY.
4 PCS



WITH 1 1/2" PUSH ON NUT COVERS
THUB-RP112

- 1 1/2" Push On Nut Cover Installation
- Rust Resistant
- Removable Rear Hubcap to Access Axle
- Designed to Fit
 - Most 11 1/4" Bolt Circle/Center Applications
 - Most 20", 22.5" & 24.5" Wheels

TECHNICAL SPECIFICATIONS

KIT INCLUDES	1 x Chrome ABS Plastic Rear Axle Cover with Removable Dome Hubcap 10 x Chrome ABS Plastic 1 1/2" Push On Nut Covers 2 x Locking Rings
--------------	---------------------------------------------------------------------------------------------------------------------------------------------

BOX DIMENSIONS	36" x 14.5" x 15"
SOLD	As a Kit
WARRANTY	1 Year



CASE QTY.
4 PCS

REAR AXLE ACCESSORIES REAR AXLE COVER | DOME HUBCAP - CHROME ABS PLASTIC

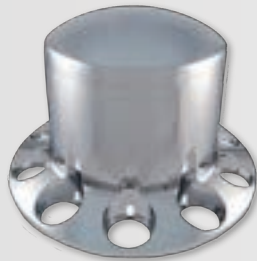

REAR AXLE COVER WITH REPLACEMENT DOME HUBCAP
THUB-RPN Nut Covers NOT Included

- Rust Resistant
- Removable Rear Hubcap to Access Axle
- Designed to Fit
 - Most 11 1/4" Bolt Circle/Center Applications
 - Most 20", 22.5" & 24.5" Wheels

TECHNICAL SPECIFICATIONS

BOX DIMENSIONS	14" x 8.5" x 14"
SOLD	Individually
WARRANTY	1 Year



CASE QTY.
4 PCS



REAR AXLE COVER REPLACEMENT DOME HUBCAP
THUB-RP

- Rust Resistant
- Designed to Fit
 - Most 11 1/4" Bolt Circle/Center Applications
 - Rear Axle Kits: THUB-RP33, THUB-RP33PO, THUB-RP112 & THUB-RPN

TECHNICAL SPECIFICATIONS

SOLD	Individually
WARRANTY	1 Year



CASE QTY.
100 PCS

WARNING: Cancer and Reproductive Harm - www.p65warnings.ca.gov

POINTED REAR AXLE COVER KIT CHROME ABS PLASTIC



WITH 33MM THREADED POINTED NUT COVERS
THUB-RP33P

- Threaded Pointed Nut Cover Installation
- Rust Resistant
- Removable Rear Hubcap to Access Axle
- Designed to Fit
 - Most 11 1/4" Bolt Circle/Center Applications
 - Most 20", 22.5" & 24.5" Wheels

TECHNICAL SPECIFICATIONS

KIT INCLUDES	1 x Chrome ABS Plastic Pointed Rear Axle Cover with Removable Pointed Hubcap 10 x Chrome ABS Plastic 33mm Threaded Pointed Nut Covers
--------------	------------------------------------------------------------------------------------------------------------------------------------------

BOX DIMENSIONS	36" x 14.5" x 15"
SOLD	As a Kit
WARRANTY	1 Year



CASE QTY.
4 PCS

POINTED REAR AXLE COVER CHROME ABS PLASTIC



REAR AXLE COVER WITH REPLACEMENT POINTED HUBCAP
THUB-RPNP Nut Covers NOT Included

- Rust Resistant
- Removable Rear Hubcap to Access Axle
- Designed to Fit
 - Most 11 1/4" Bolt Circle/Center Applications
 - Most 20", 22.5" & 24.5" Wheels

TECHNICAL SPECIFICATIONS

KIT INCLUDES	1 x Chrome ABS Plastic Pointed Rear Axle Cover with Removable Pointed Hubcap
--------------	------------------------------------------------------------------------------

BOX DIMENSIONS	14" x 8.5" x 14"
SOLD	Individually
WARRANTY	1 Year



CASE QTY.
4 PCS



UNIVERSAL ACCESSORIES

NUT COVER KITS CHROME ABS PLASTIC

**TOP
SELLER**



33MM WITH FLANGE
TNUT-C1 Push On Nut Covers

**BOX OF 60 NUT COVERS
OUTFITS THE WHOLE TRUCK**

- Push On Nut Cover Installation
- Designed to Fit
33mm Lug Nuts

TECHNICAL SPECIFICATIONS

NUT COVER HEIGHT	2.5"
BOX DIMENSIONS	12.6" x 10.63" x 5.63"
SOLD	Box of 60
WARRANTY	1 Year



CASE QTY.
4 PCS



33MM WITH FLANGE
TNUT-C4 Threaded Nut Covers

**BOX OF 60 NUT COVERS
OUTFITS THE WHOLE TRUCK**

- Threaded Pointed Nut Cover Installation
- Designed to Fit
33mm Lug Nuts with 3 or 4 Exposed Thread (For Threaded Nut Covers)

TECHNICAL SPECIFICATIONS

NUT COVER HEIGHT	5"
BOX DIMENSIONS	12.6" x 10.63" x 5.63"
SOLD	Box of 60
WARRANTY	1 Year



CASE QTY.
4 PCS

PUSH ON NUT COVERS CHROME ABS PLASTIC

**TOP
SELLER**



33MM WITH FLANGE
TNUT-F2

TECHNICAL SPECIFICATIONS

NUT COVER HEIGHT	2.5"
SOLD	Individually
WARRANTY	1 Year

CASE QTY.
500 PCS



33MM
TNUT-F2L

TECHNICAL SPECIFICATIONS

NUT COVER HEIGHT	4"
SOLD	Individually
WARRANTY	1 Year

CASE QTY.
120 PCS



1 1/2"
TNUT-B2

TECHNICAL SPECIFICATIONS

NUT COVER HEIGHT	3"
SOLD	Individually
WARRANTY	1 Year

CASE QTY.
500 PCS



33MM WITH FLANGE
TNUT-F2TP

TECHNICAL SPECIFICATIONS

NUT COVER HEIGHT	3"
SOLD	Individually
WARRANTY	1 Year

CASE QTY.
500 PCS

⚠ WARNING: Cancer and Reproductive Harm - www.p65warnings.ca.gov

PUSH ON NUT COVERS

CHROME METAL | STAINLESS STEEL



33MM CHROME METAL
TNUT-B1

TECHNICAL SPECIFICATIONS

NUT COVER HEIGHT	2"
SOLD	Individually
WARRANTY	1 Year



33MM CHROME METAL WITH FLANGE
TNUT-F1

TECHNICAL SPECIFICATIONS

NUT COVER HEIGHT	2"
SOLD	Individually
WARRANTY	1 Year



33MM STAINLESS STEEL WITH FLANGE
TNUT-F1SS

TECHNICAL SPECIFICATIONS

NUT COVER HEIGHT	2"
SOLD	Individually
WARRANTY	1 Year



THREADED NUT COVERS

CHROME ABS PLASTIC



33MM WITH FLANGE
TNUT-F2T

TECHNICAL SPECIFICATIONS

NUT COVER HEIGHT	3"
SOLD	Individually
WARRANTY	1 Year



BLACK 33MM WITH FLANGE
TNUT-F2TB

TECHNICAL SPECIFICATIONS

NUT COVER HEIGHT	3"
SOLD	Individually
WARRANTY	1 Year



33MM WITH FLANGE
TNUT-F2TL

TECHNICAL SPECIFICATIONS

NUT COVER HEIGHT	4"
SOLD	Individually
WARRANTY	1 Year



33MM WITH FLANGE
TNUT-P1

TECHNICAL SPECIFICATIONS

NUT COVER HEIGHT	5"
SOLD	Individually
WARRANTY	1 Year



LUG NUT TOOLS



1 1/2" & 33MM (PUSH ON) LUG NUT PULLER
TU-1033

TECHNICAL SPECIFICATIONS

DESIGNED FOR	33mm & 1 1/2" Lug Nuts
MATERIAL	Vinyl & Metal
SOLD	Individually



33MM THREADED LUG NUT COVER WENCH
TU-1037

TECHNICAL SPECIFICATIONS

DESIGNED FOR	33mm Threaded Lug Nuts
MATERIAL	Plastic
SOLD	Individually

UNIVERSAL ACCESSORIES

6 UNEVEN NOTCH FRONT HUBCAPS CHROME METAL | STAINLESS STEEL

**TOP
SELLER**



▲ CHROME METAL DOME
THUB-6N

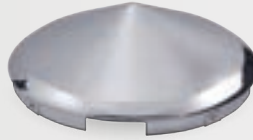

▲ CHROME METAL POINTED
THUB-6NP

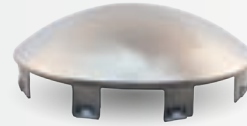

▲ STAINLESS STEEL DOME
THUB-6NSS

TECHNICAL SPECIFICATIONS

LIP SIZE	7/16" Lip
WHAT'S INCLUDED	6 Uneven Notches & Clips
SOLD	Individually
WARRANTY	1 Year

DESIGNED TO FIT

4,5 and 6 Notch Piloted Wheels Only
Compatible with Stud or Hub Piloted Wheels
For 20", 22.5" & 24.5" Steel Wheels
Oil Axles Only



CASE QTY.
50 PCS

5 NOTCH FRONT HUBCAPS CHROME METAL | STAINLESS STEEL



▲ CHROME METAL DOME
THUB-5N

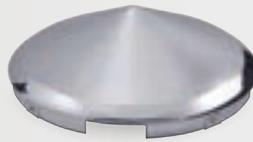

▲ CHROME METAL POINTED
THUB-5NP

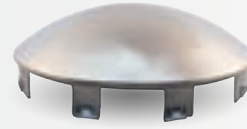

▲ STAINLESS STEEL DOME
THUB-5NSS

TECHNICAL SPECIFICATIONS

LIP SIZE	7/16" Lip
WHAT'S INCLUDED	5 Notches & Clips
SOLD	Individually
WARRANTY	1 Year

DESIGNED TO FIT

5 Notch Piloted Wheels Only
Compatible with Stud or Hub Piloted Wheels
For 20", 22.5" & 24.5" Steel Wheels
Oil Axles Only



CASE QTY.
50 PCS

4 NOTCH FRONT HUBCAPS CHROME METAL | STAINLESS STEEL



▲ CHROME METAL DOME
THUB-4N



▲ CHROME METAL POINTED
THUB-4NP

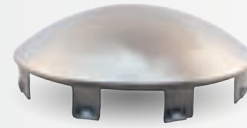

▲ STAINLESS STEEL DOME
THUB-4NSS

TECHNICAL SPECIFICATIONS

LIP SIZE	7/16" Lip
WHAT'S INCLUDED	4 Notches & Clips
SOLD	Individually
WARRANTY	1 Year

DESIGNED TO FIT

4 Notch Piloted Wheels Only
Compatible with Stud or Hub Piloted Wheels
For 20", 22.5" & 24.5" Steel Wheels
Oil Axles Only



CASE QTY.
50 PCS

WARNING: Cancer and Reproductive Harm - www.p65warnings.ca.gov

8" I.D REAR HUBCAPS

CHROME METAL | STAINLESS STEEL

TOP SELLER



▲ CHROME METAL DOME
THUB-858



▲ STAINLESS STEEL DOME
THUB-858SS



▲ CHROME METAL POINTED
THUB-858P

TECHNICAL SPECIFICATIONS

LIP SIZE	1" Lip
SOLD	Individually
WARRANTY	1 Year

DESIGNED TO FIT	8 1/4" Diameter Rear Axles with 8 x 5/8" Studs Compatible with Hub Piloted Wheels Most Peterbilt, Kenworth & Freightliner Trucks
-----------------	----------------------------------------------------------------------------------------------------------------------------------------



CASE QTY.
50 PCS

For Axle Housing Nuts that take a 24mm socket an 8" Hubcap is required.

8 1/4" I.D REAR HUBCAPS

CHROME METAL | STAINLESS STEEL



▲ CHROME METAL DOME
THUB-834



▲ CHROME METAL POINTED
THUB-834P



▲ STAINLESS STEEL DOME
THUB-834SS



▲ STAINLESS STEEL DOME
INTERNATIONAL 2003+ MODELS
THUB-834SS2003

TECHNICAL SPECIFICATIONS

LIP SIZE	1" Lip THUB-833SS2003: 1 1/2" Lip
SOLD	Individually
WARRANTY	1 Year

DESIGNED TO FIT	8 1/2" Diameter Rear Axles with 8 x 3/4" Studs Compatible with Hub Piloted Wheels Most International, Volvo & some Mack Trucks
-----------------	--------------------------------------------------------------------------------------------------------------------------------------



CASE QTY.
50 PCS

For Axle Housing Nuts that take a 28mm socket an 8 1/4" Hubcap is required.

7 1/4" I.D REAR HUBCAP

CHROME METAL



▲ CHROME METAL DOME
THUB-712

TECHNICAL SPECIFICATIONS

LIP SIZE	1" Lip
SOLD	Individually
WARRANTY	1 Year

DESIGNED TO FIT	7 1/2" Diameter Rear Axles with 12 x 1/2" Studs Compatible with Hub Piloted Wheels Oil Axles Only
-----------------	---------------------------------------------------------------------------------------------------------



CASE QTY.
50 PCS

UNIVERSAL ACCESSORIES



- 430 Mirror Shine Stainless Steel
- 18 Gauge Flat Top Design
- Spring Loaded
- LED Lighting with Grommets & Bezels*
- Locking Nuts Included
- Pre-Wired & Assembled Kits*

*Applies to Specific Products



SOLD IN
RETAIL PACKAGING

30" MUD FLAP HANGERS - 3 3/4" BOLT SPACING

STANDARD LEDS - STAINLESS STEEL - FLAT TOP



▲
6 x 4" HOLES
TU-9209

TECHNICAL SPECIFICATIONS

BOLT SPACING	3 3/4"
DOT/SAE	Compliant
FUNCTION	Stop, Turn & Tail
WARRANTY	1 Year

**TOP
SELLER**



▲
RED STOP, TURN & TAIL
TU-9209L1 Red Lens



▲
RED STOP, TURN & TAIL
TU-9209LC Clear Lens

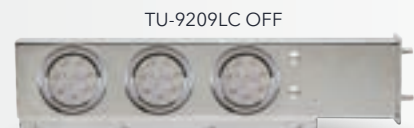
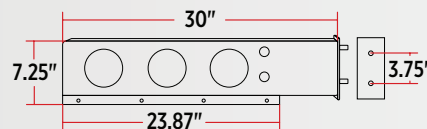

Attach to the chassis using a hand wrench and supplied hardware. Warranty VOID if power tools are used for the installation.

PART NUMBER	TU-9209	TU-9209L1	TU-9209LC
KIT INCLUDES	2 x Mud Flap Hangers with 4" Holes	2 x Mud Flap Hangers 6 x TLED-48R 6 x TBEZ-4CH4 6 x TGRO-4R	2 x Mud Flap Hangers 6 x TLED-48CR 6 x TBEZ-4CH4 6 x TGRO-4R

⚠ WARNING: Cancer and Reproductive Harm - www.p65warnings.ca.gov



30" MUD FLAP HANGERS - 3 3/4" BOLT SPACING

DUAL REVOLUTION LEDS - STAINLESS STEEL - FLAT TOP

**TOP
SELLER**

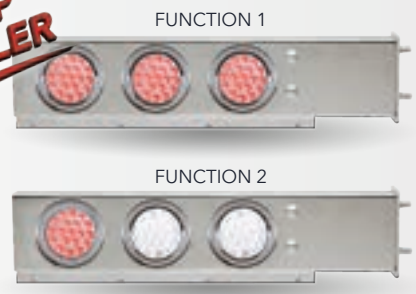

RED STOP, TURN & TAIL TO **WHITE** BACK UP
TU-9209L2 Clear Lens

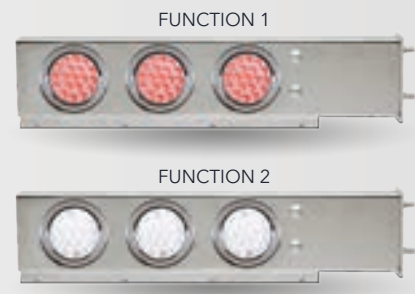

RED STOP, TURN & TAIL TO **WHITE** BACK UP
TU-9209L3 Clear Lens



RED STOP, TURN & TAIL TO **BLUE** AUXILIARY
TU-9209L4 Clear Lens

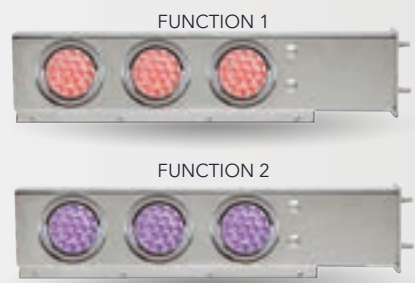

RED STOP, TURN & TAIL TO **PURPLE** AUXILIARY
TU-9209L5 Clear Lens

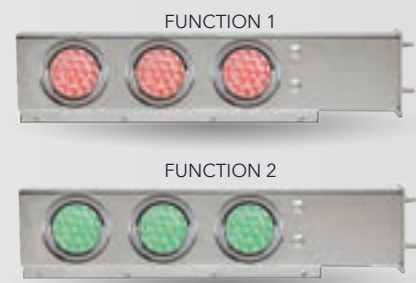

RED STOP, TURN & TAIL TO **GREEN** AUXILIARY
TU-9209L6 Clear Lens

TECHNICAL SPECIFICATIONS

BOLT SPACING	3 3/4"
DOT/SAE	DOT to Auxiliary
FUNCTIONS	Stop, Turn & Tail to Auxiliary
WARRANTY	1 Year

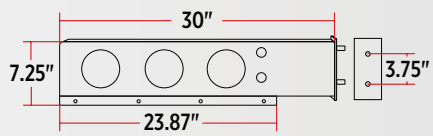

Attach to the chassis using a hand wrench and supplied hardware. Warranty VOID if power tools are used for the installation.

PART NUMBER	TU-9209L2	TU-9209L3	TU-9209L4	TU-9209L5	TU-9209L6
KIT INCLUDES	2 x Mud Flap Hangers 4 x TLED-4X40 2 x TLED-419CR 6 x TBEZ-4CH4 6 x TGRO-4R	2 x Mud Flap Hangers 6 x TLED-4X40 6 x TBEZ-4CH4 6 x TGRO-4R	2 x Mud Flap Hangers 6 x TLED-4XRB 6 x TBEZ-4CH4 6 x TGRO-4R	2 x Mud Flap Hangers 6 x TLED-4XRP 6 x TBEZ-4CH4 6 x TGRO-4R	2 x Mud Flap Hangers 6 x TLED-4XRG 6 x TBEZ-4CH4 6 x TGRO-4R

WARNING: Cancer and Reproductive Harm - www.p65warnings.ca.gov

UNIVERSAL ACCESSORIES

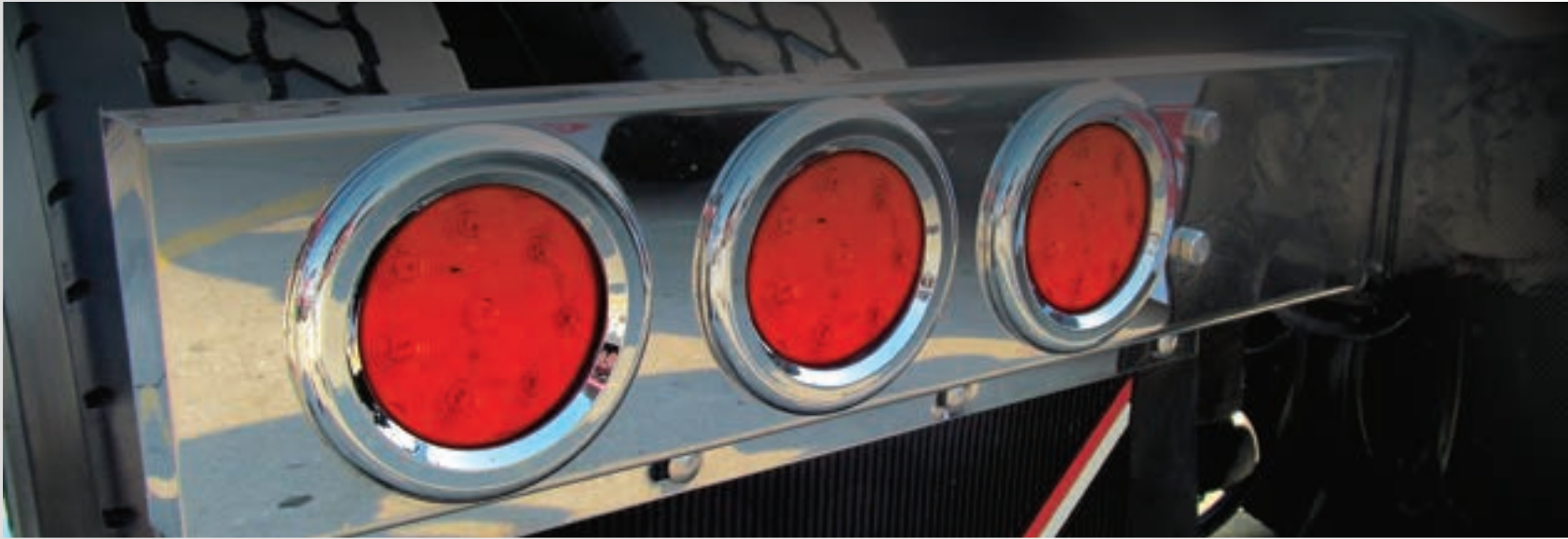

- 430 Mirror Shine Stainless Steel
- 18 Gauge Flat Top Design
- Spring Loaded
- LED Lighting with Grommets & Bezels*
- Locking Nuts Included
- Pre-Wired & Assembled Kits*

*Applies to Specific Products



SOLD IN
RETAIL PACKAGING

30" MUD FLAP HANGERS - 2 1/2" BOLT SPACING

STANDARD LEDS - STAINLESS STEEL - FLAT TOP



▲
6 x 4" HOLES
TU-9210

**TOP
SELLER**



▲
RED STOP, TURN & TAIL
TU-9210L1 Red Lens



▲
RED STOP, TURN & TAIL
TU-9210LC Clear Lens

TECHNICAL SPECIFICATIONS

BOLT SPACING	2 1/2"
DOT/SAE	Compliant
FUNCTION	Stop, Turn & Tail
WARRANTY	1 Year

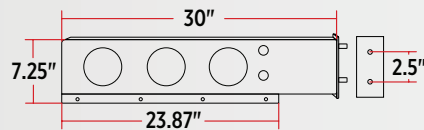

TU-9210LC OFF
Attach to the chassis using a hand wrench and supplied hardware. Warranty VOID if power tools are used for the installation.

PART NUMBER	TU-9210	TU-9210L1	TU-9210LC
KIT INCLUDES	2 x Mud Flap Hangers with 4" Holes	2 x Mud Flap Hangers 6 x TLED-48R 6 x TBEZ-4CH4 6 x TGRO-4R	2 x Mud Flap Hangers 6 x TLED-48CR 6 x TBEZ-4CH4 6 x TGRO-4R

⚠ WARNING: Cancer and Reproductive Harm - www.p65warnings.ca.gov



30" LED MUD FLAP HANGERS - 2 1/2" BOLT SPACING
 DUAL REVOLUTION LEDS - STAINLESS STEEL - FLAT TOP

TOP SELLER



RED STOP, TURN & TAIL TO **WHITE** BACK UP
TU-9210L2 Clear Lens

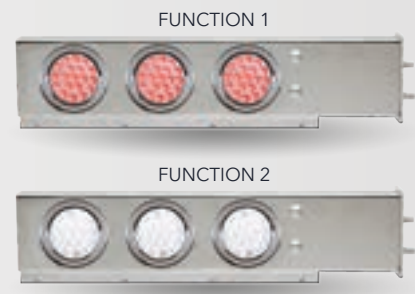

RED STOP, TURN & TAIL TO **WHITE** BACK UP
TU-9210L3 Clear Lens

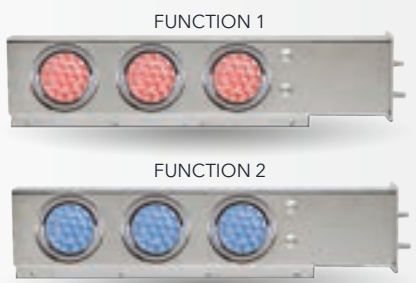

RED STOP, TURN & TAIL TO **BLUE** AUXILIARY
TU-9210L4 Clear Lens

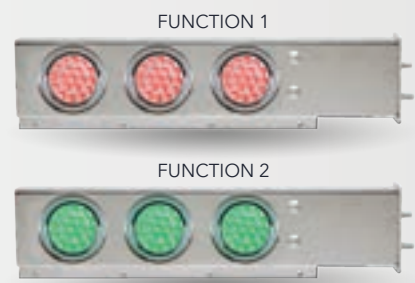

RED STOP, TURN & TAIL TO **GREEN** AUXILIARY
TU-9210L5 Clear Lens

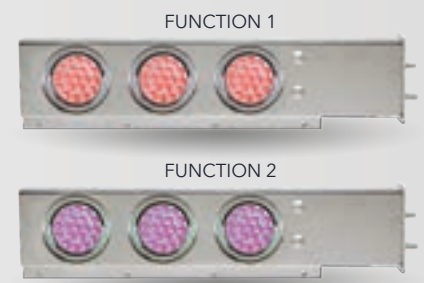

RED STOP, TURN & TAIL TO **PURPLE** AUXILIARY
TU-9210L6 Clear Lens

TECHNICAL SPECIFICATIONS

BOLT SPACING	2 1/2"
DOT/SAE	DOT to Auxiliary
FUNCTIONS	Stop, Turn & Tail to Auxiliary
WARRANTY	1 Year

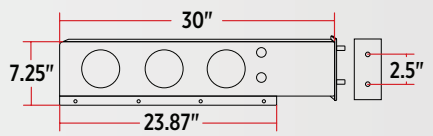

Attach to the chassis using a hand wrench and supplied hardware. Warranty VOID if power tools are used for the installation.

PART NUMBER	TU-9210L2	TU-9210L3	TU-9210L4	TU-9210L5	TU-9210L6
KIT INCLUDES	2 x Mud Flap Hangers 4 x TLED-4X40 2 x TLED-419CR 6 x TBEZ-4CH4 6 x TGRO-4R	2 x Mud Flap Hangers 6 x TLED-4X40 6 x TBEZ-4CH4 6 x TGRO-4R	2 x Mud Flap Hangers 6 x TLED-4XRB 6 x TBEZ-4CH4 6 x TGRO-4R	2 x Mud Flap Hangers 6 x TLED-4XRG 6 x TBEZ-4CH4 6 x TGRO-4R	2 x Mud Flap Hangers 6 x TLED-4XRP 6 x TBEZ-4CH4 6 x TGRO-4R

WARNING: Cancer and Reproductive Harm - www.p65warnings.ca.gov

UNIVERSAL ACCESSORIES

30" OVAL LED MUD FLAP HANGERS - 3 3/4" BOLT SPACING SPRING LOADED - STAINLESS STEEL



▲
6 x OVAL HOLES
TU-9217



▲
RED STOP, TURN & TAIL
TU-9217L Red Lens



▲
RED STOP, TURN & TAIL
TU-9217LC Clear Lens

TECHNICAL SPECIFICATIONS

BOLT SPACING	3 3/4"
DOT/SAE	Compliant
FUNCTION	Stop, Turn & Tail
WARRANTY	1 Year

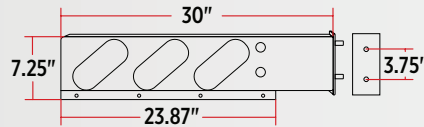

TU-9217LC OFF

Attach to the chassis using a hand wrench and supplied hardware. Warranty VOID if power tools are used for the installation.

PART NUMBER	TU-9217	TU-9217L	TU-9217LC
KIT INCLUDES	2 x Mud Flap Hangers with 6" Oval Holes	2 x Mud Flap Hangers 6 x TLED-OBMR 6 x TBEZ-OBCH4 6 x TGRO-OBR	2 x Mud Flap Hangers 6 x TLED-OBMCR 6 x TBEZ-OBCH4 6 x TGRO-OBR

33" MUD FLAP HANGERS - 2 1/2" BOLT SPACING SPRING LOADED - STAINLESS STEEL



▲
6 x 4" HOLES
TU-9258



▲
NO LEDs
TU-9259

TECHNICAL SPECIFICATIONS

BOLT SPACING	2 1/2"
WHAT'S INCLUDED	Locking Nuts
SOLD	As a Pair
WARRANTY	1 Year

TU-9258

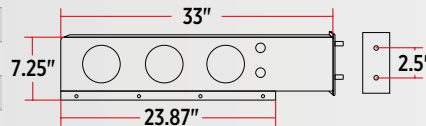

TU-9259

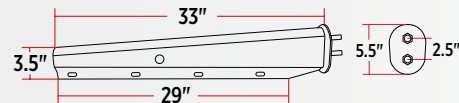

Attach to the chassis using a hand wrench and supplied hardware. Warranty VOID if power tools are used for the installation.

TOP FLAP LIGHT BARS

STAINLESS STEEL



▲ NO LEDs
TU-9245



▲ RED MARKER
TU-9245LF Red Lens



▲ RED MARKER
TU-9245LFC Clear Lens



▲ WHITE MARKER
TU-9245LFC2 White Lens

TECHNICAL SPECIFICATIONS

DESIGNED TO FIT	30" Top Mud Flap Hangers
FUNCTION	Marker
SOLD	As a Pair
WARRANTY	1 Year

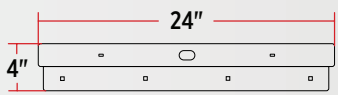

REFLECTOR STRIPS

ALUMINUM



▲ STRAIGHT
TU-9249



▲ ANGLED
TU-9250

TECHNICAL SPECIFICATIONS

DESIGNED TO FIT	Straight & Angled Mud Flap Hangers
WHAT'S INCLUDED	3M Tape
SOLD	As a Pair

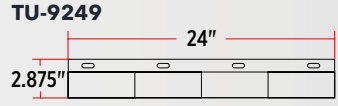

TU-9249

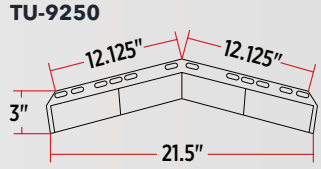

TU-9250

REPLACEMENT SPRINGS

STEEL



▲ 6" Spring Length
TU-9248



▲ 10 5/8" Spring Length
TU-9230



▲ 14 1/8" Spring Length
TU-9231

TECHNICAL SPECIFICATIONS

DESIGNED TO FIT	Most Makes & Models
SOLD	Individually

Professional Installation Recommended

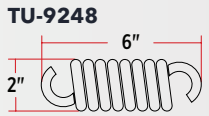

TU-9248

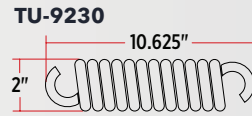

TU-9230

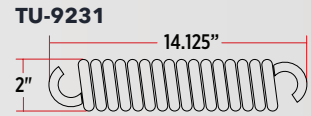

TU-9231

▲ WARNING: Cancer and Reproductive Harm - www.p65warnings.ca.gov

UNIVERSAL ACCESSORIES

45° ANGLED 30" MUD FLAP HANGERS - 2 1/2" BOLT SPACING SPRING LOADED - CLOSED END CAP



▲
CHROME METAL
TU-9227



▲
PAINTED STEEL
TU-9228



▲
STAINLESS STEEL
TU-9229

TECHNICAL SPECIFICATIONS

BOLT SPACING	2 1/2"
WHAT'S INCLUDED	Locking Nuts
SOLD	As a Pair
WARRANTY	1 Year

Attach to the chassis using a hand wrench & supplied hardware. Warranty VOID if power tools are used for the installation.

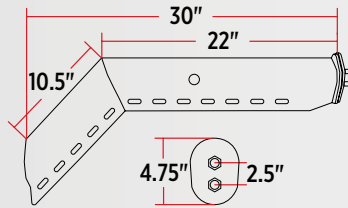

45° ANGLED 30" MUD FLAP HANGERS - 1 1/8" BOLT SPACING SPRING LOADED - CLOSED END CAP



▲
CHROME STEEL
TU-9221



▲
PAINTED STEEL
TU-9222



▲
STAINLESS STEEL
TU-9223

TECHNICAL SPECIFICATIONS

BOLT SPACING	1 1/8"
WHAT'S INCLUDED	Locking Nuts
SOLD	As a Pair
WARRANTY	1 Year

Attach to the chassis using a hand wrench & supplied hardware. Warranty VOID if power tools are used for the installation.

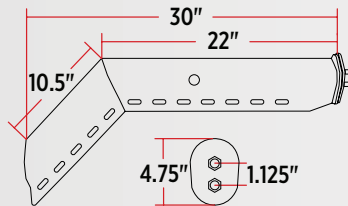

▲ WARNING: Cancer and Reproductive Harm - www.p65warnings.ca.gov

30" MUD FLAP HANGERS - 2 1/2" BOLT SPACING

SPRING LOADED - OPEN END CAP

**TOP
SELLER**



▲
STAINLESS STEEL
TU-9214

▲
CHROME STEEL
TU-9232

▲
PAINTED STEEL
TU-9233

TECHNICAL SPECIFICATIONS

BOLT SPACING	2 1/2"
WHAT'S INCLUDED	Locking Nuts
SOLD	As a Pair
WARRANTY	1 Year

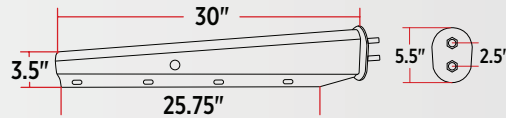

**SOLD IN
RETAIL PACKAGING**

Attach to the chassis using a hand wrench & supplied hardware. Warranty VOID if power tools are used for the installation.

30" MUD FLAP HANGERS - 1 1/8" BOLT SPACING

SPRING LOADED - OPEN END CAP

**TOP
SELLER**



▲
STAINLESS STEEL
TU-9215

▲
STAINLESS STEEL - SLIM DESIGN
TU-9226 With Dual Back Plate



▲
CHROME STEEL
TU-9224

▲
PAINTED STEEL
TU-9225

TECHNICAL SPECIFICATIONS

BOLT SPACING	1 1/8"
WHAT'S INCLUDED	Locking Nuts
SOLD	As a Pair
WARRANTY	1 Year

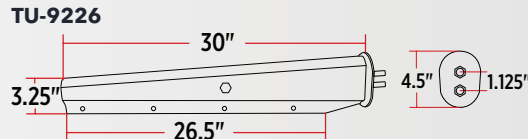
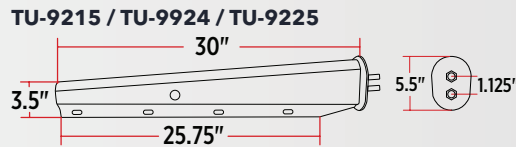

Attach to the chassis using a hand wrench & supplied hardware. Warranty VOID if power tools are used for the installation.

▲ **WARNING: Cancer and Reproductive Harm - www.p65warnings.ca.gov**

UNIVERSAL ACCESSORIES

3 BELL TRAIN HORN CHROME

**TOP
SELLER**



130-135 DECIBELS
THORN-1

TECHNICAL SPECIFICATIONS

MATERIAL	Zinc Plated with Chrome
OPERATING VOLTAGE	12-24 Volts
DECIBELS	130-135 Decibels
DIAPHRAGM MATERIAL	Chrome Metal
REQUIREMENT	Minimum 120 PSI of Air
WHAT'S INCLUDED	Mounting Bracket Electric Solenoid Valve
SOLD	Individually
WARRANTY	1 Year

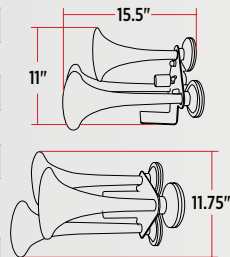

4 BELL TRAIN HORN CHROME



140-145 DECIBELS
THORN-2

TECHNICAL SPECIFICATIONS

MATERIAL	Zinc Plated with Chrome
OPERATING VOLTAGE	12-24 Volts
DECIBELS	140-145 Decibels
DIAPHRAGM MATERIAL	Chrome Metal
REQUIREMENT	Minimum 120 PSI of Air
WHAT'S INCLUDED	Mounting Bracket Electric Solenoid Valve
SOLD	Individually
WARRANTY	1 Year

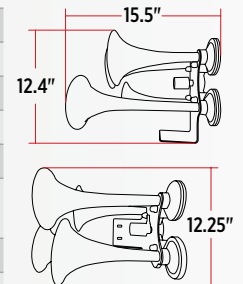

TRAIN HORN DIAPHRAGM REPLACEMENT



DIAPHRAGM
THORN-D

TECHNICAL SPECIFICATIONS

MATERIAL	Chrome Metal
SOLD	Individually

Remove the back cap off the Train Horn and attach using the existing hardware.

TRAIN HORN SOLENOID VALVE REPLACEMENT



REPLACEMENT SOLENOID VALVE
THORN-SV

TECHNICAL SPECIFICATIONS

OPERATING VOLTAGE	12-24 Volts
SOLD	Individually

Replacement Valve for THORN-1 & THORN-2

WARNING: Cancer and Reproductive Harm - www.p65warnings.ca.gov

LICENSE PLATE HOLDERS

STAINLESS STEEL



▲
TRIPLE PLATE
TU-1714



▲
DOUBLE PLATE
TU-1715



▲
SINGLE PLATE
TU-1716

TECHNICAL SPECIFICATIONS

SOLD	Individually
MATERIAL	Stainless Steel

INCLUDES	License Plate Bezels All Hardware
----------	--------------------------------------

Mounts onto the bottom edge of the front bumper using supplied hardware.

5TH WHEEL PULLER

CHROMED STEEL



▲
WITH HOOK
TU-1030

TECHNICAL SPECIFICATIONS

DIMENSIONS	Full Pole: 36" Long x 0.375" Diameter Handle: 4.88" Long x 0.75" Diameter
SOLD	Individually
MATERIAL	Chromed Steel

For Installation, Reach & Release 'King Pin' from under the trailer

BOOT BRUSHES

CHROMED ALUMINUM - BLACK BRISTLES

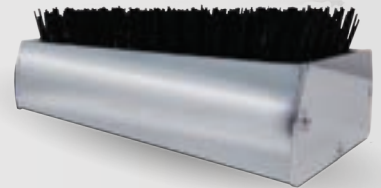

▲
NO LEDS
TU-1400

TECHNICAL SPECIFICATIONS

DIMENSIONS	7.5" x 3.25" x 1.75"
SOLD	Individually
MATERIAL	Chromed Aluminum

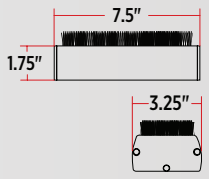

UNIVERSAL ACCESSORIES

24" BOLTED BOTTOM MUD FLAP WEIGHTS STAINLESS STEEL

**TOP
SELLER**

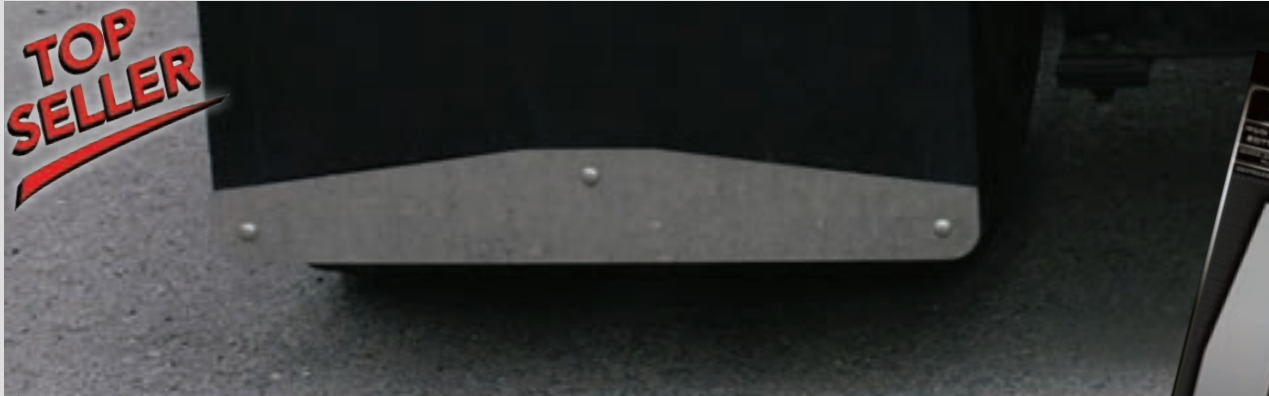

ANGLED
TU-9246 With Backing Plates

TECHNICAL SPECIFICATIONS

WHAT'S INCLUDED	Bolt Kit
MATERIAL	Stainless Steel
SOLD	As a Pair
WARRANTY	1 Year



**SOLD IN
RETAIL
PACKAGING**

24" BOLTED BOTTOM MUD FLAP WEIGHTS - STAINLESS STEEL



WAVE
TU-9239

TECHNICAL SPECIFICATIONS

WHAT'S INCLUDED	Bolt Kit
MATERIAL	Stainless Steel
SOLD	As a Pair
WARRANTY	1 Year

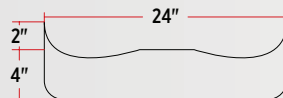

24" WELDED BOTTOM MUD FLAP WEIGHTS

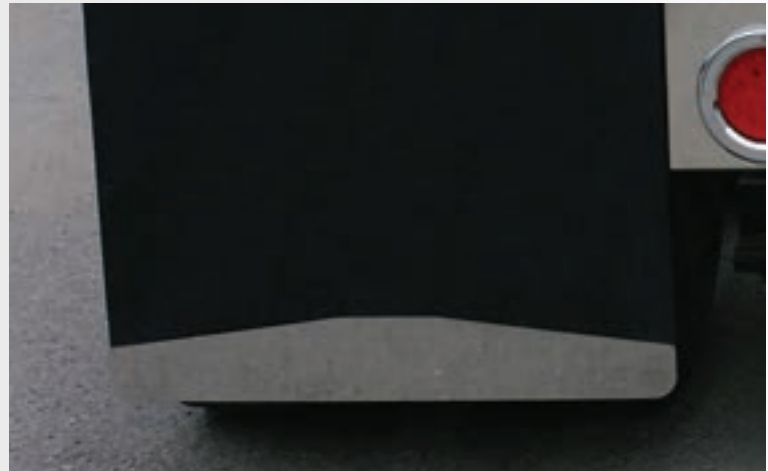

ANGLED
TU-9204 Stainless Steel
TU-9241 Stainless Steel
with Backing Plate
TU-9242 Chrome

TECHNICAL SPECIFICATIONS

WHAT'S INCLUDED	Welded Studs & Hardware
SOLD	TU-9204: As a Pair TU-9241: Individually TU-9242: Individually
WARRANTY	1 Year

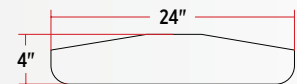

WARNING: Cancer and Reproductive Harm - www.p65warnings.ca.gov

ANTI-SAIL BRACKETS

CHROME | STAINLESS STEEL



CHROME
TU-1031

STAINLESS STEEL
TU-1032

TECHNICAL SPECIFICATIONS

DIMENSIONS	24" x 21"
SOLD	Individually
WARRANTY	1 Year

ANTI-SAIL FLAP PLATE

STAINLESS STEEL



STAINLESS STEEL
TU-9208

TECHNICAL SPECIFICATIONS

DESIGNED FOR	Straight Mud Flaps
DIMENSIONS	14" x 18"
SOLD	As a Pair
WARRANTY	1 Year

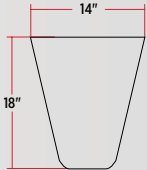

Reduces Wear & Tear by securing Mud Flap into place.
Will NOT fit angled Mud Flaps.

MUD FLAPS

CHROME



CHROME
TM-24 24" x 24" (W x H)
TM-30 24" x 30" (W x H)

TECHNICAL SPECIFICATIONS

SOLD	As a Pair
------	-----------



UNIVERSAL ACCESSORIES



- 430 Mirror Shine Stainless Steel
- LED Lighting with Grommets & Bezels*
- License Plate Frame with License LEDs*
- Pre-Wired & Assembled*
- Aluminum Composite Back Plate
- Reinforced Brackets for Mounting Holes

*Applies to Specific Products



SOLD IN
RETAIL PACKAGING

LED REAR CENTER PANELS - 4" & 2" STANDARD LEDS STAINLESS STEEL



4 x 4" HOLES & 6 x 2" HOLES
TU-9001

**TOP
SELLER**



RED STOP, TURN & TAIL
TU-9001L Red Lens



RED STOP, TURN & TAIL
TU-9001LC Clear Lens

TECHNICAL SPECIFICATIONS

DOT/SAE	Compliant
FUNCTION	Stop, Turn & Tail
WARRANTY	1 Year

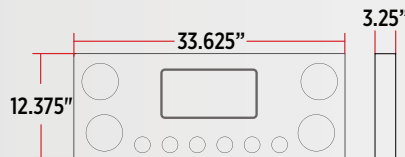

PART NUMBER	TU-9001	TU-9001L	TU-9001LC
KIT INCLUDES	1 x Rear Center Panel 1 x Composite Back Plate	1 x Rear Center Panel 4 x TLED-48R 6 x TLED-2R 4 x TBEZ-4CH4 6 x TBEZ-2CH4 4 x TGRO-4R 6 x TGRO-2R 1 x License Plate 2 x License LEDs 1 x Composite Back Plate	1 x Rear Center Panel 4 x TLED-48CR 6 x TLED-2TR 4 x TBEZ-4CH4 6 x TBEZ-2CH4 4 x TGRO-4R 6 x TGRO-2R 1 x License Plate 2 x License LEDs 1 x Composite Back Plate

WARNING: Cancer and Reproductive Harm - www.p65warnings.ca.gov

LED REAR CENTER PANELS - 4" & 2" DUAL REVOLUTION LEDS STAINLESS STEEL

**TOP
SELLER**



FUNCTION 1



FUNCTION 1



FUNCTION 2



FUNCTION 2

▲ **RED STOP, TURN & TAIL TO WHITE BACK UP**
TU-9001L2 Clear Lens

▲ **RED STOP, TURN & TAIL TO WHITE BACK UP**
TU-9001L3 Clear Lens



FUNCTION 1



FUNCTION 1



FUNCTION 1



FUNCTION 2



FUNCTION 2



FUNCTION 2

▲ **RED STOP, TURN & TAIL TO BLUE AUXILIARY**
TU-9001L4 Clear Lens

▲ **RED STOP, TURN & TAIL TO PURPLE AUXILIARY**
TU-9001L5 Clear Lens

▲ **RED STOP, TURN & TAIL TO GREEN AUXILIARY**
TU-9001L6 Clear Lens

TECHNICAL SPECIFICATIONS

DOT/SAE	DOT to Auxiliary
FUNCTIONS	Stop, Turn & Tail to Auxiliary
WARRANTY	1 Year

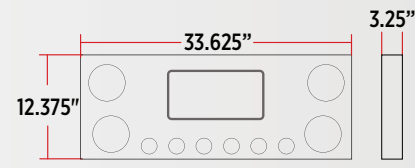

OFF

PART NUMBER	TU-9001L2	TU-9001L3	TU-9001L4	TU-9001L5	TU-9001L6
KIT INCLUDES	1 x Rear Center Panel 2 x TLED-419CR 2 x TLED-4X40 6 x TLED-2XRW 4 x TBEZ-4CH4 6 x TBEZ-2CH4 4 x TGRO-4R 6 x TGRO-2R 1 x License Plate 2 x License LEDs 1 x Composite Back Plate	1 x Rear Center Panel 4 x TLED-4X40 6 x TLED-2XRW 4 x TBEZ-4CH4 6 x TBEZ-2CH4 4 x TGRO-4R 6 x TGRO-2R 1 x License Plate 2 x License LEDs 1 x Composite Back Plate	1 x Rear Center Panel 4 x TLED-4XRB 6 x TLED-2XRB 4 x TBEZ-4CH4 6 x TBEZ-2CH4 4 x TGRO-4R 6 x TGRO-2R 1 x License Plate 2 x License LEDs 1 x Composite Back Plate	1 x Rear Center Panel 4 x TLED-4XRP 6 x TLED-2XRP 4 x TBEZ-4CH4 6 x TBEZ-2CH4 4 x TGRO-4R 6 x TGRO-2R 1 x License Plate 2 x License LEDs 1 x Composite Back Plate	1 x Rear Center Panel 4 x TLED-4XRG 6 x TLED-2XRG 4 x TBEZ-4CH4 6 x TBEZ-2CH4 4 x TGRO-4R 6 x TGRO-2R 1 x License Plate 2 x License LEDs 1 x Composite Back Plate

UNIVERSAL ACCESSORIES



- 430 Mirror Shine Stainless Steel
- LED Lighting with Grommets & Bezels*
- License Plate Frame with License LEDs*
- Pre-Wired & Assembled*
- Aluminum Composite Back Plate
- Reinforced Brackets for Mounting Holes

*Applies to Specific Products



SOLD IN
RETAIL PACKAGING

LED REAR CENTER PANELS - 4" & 2.5" STANDARD LEDS STAINLESS STEEL



4 x 4" HOLES & 5 x 2.5" HOLES
TU-9002

**TOP
SELLER**



RED STOP, TURN & TAIL
TU-9002L Red Lens



RED STOP, TURN & TAIL
TU-9002LC Clear Lens

TECHNICAL SPECIFICATIONS

DOT/SAE	Compliant
FUNCTION	Stop, Turn & Tail
WARRANTY	1 Year

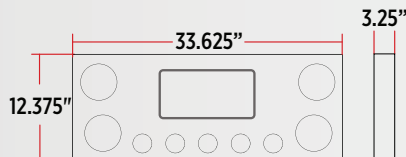

PART NUMBER	TU-9002	TU-9002L	TU-9002LC
KIT INCLUDES	1 x Rear Center Panel 1 x Composite Back Plate	1 x Rear Center Panel 4 x TLED-48R 5 x TLED-2HR 4 x TBEZ-4CH4 5 x TBEZ-2HCH4 4 x TGRO-4R 5 x TGRO-2HRO 1 x License Plate 2 x License LEDs 1 x Composite Back Plate	1 x Rear Center Panel 4 x TLED-48CR 5 x TLED-2HTR 4 x TBEZ-4CH4 5 x TBEZ-2HCH4 4 x TGRO-4R 5 x TGRO-2HRO 1 x License Plate 2 x License LEDs 1 x Composite Back Plate

WARNING: Cancer and Reproductive Harm - www.p65warnings.ca.gov

LED REAR CENTER PANELS - 4" & 2.5" DUAL REVOLUTION LEDS STAINLESS STEEL

**TOP
SELLER**



FUNCTION 1



FUNCTION 2

▲ **RED STOP, TURN & TAIL TO WHITE BACK UP**
TU-9002L2 Clear Lens



FUNCTION 1



FUNCTION 2

▲ **RED STOP, TURN & TAIL TO WHITE BACK UP**
TU-9002L3 Clear Lens



FUNCTION 1



FUNCTION 2

▲ **RED STOP, TURN & TAIL TO BLUE AUXILIARY**
TU-9002L4 Clear Lens



FUNCTION 1



FUNCTION 2

▲ **RED STOP, TURN & TAIL TO PURPLE AUXILIARY**
TU-9002L5 Clear Lens



FUNCTION 1



FUNCTION 2

▲ **RED STOP, TURN & TAIL TO GREEN AUXILIARY**
TU-9002L6 Clear Lens

TECHNICAL SPECIFICATIONS

DOT/SAE	DOT to Auxiliary
FUNCTIONS	Stop, Turn & Tail to Auxiliary
WARRANTY	1 Year

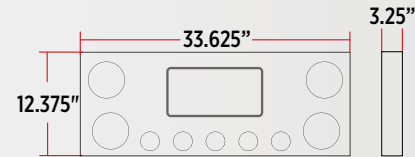

OFF

PART NUMBER	TU-9002L2	TU-9002L3	TU-9002L4	TU-9002L5	TU-9002L6
KIT INCLUDES	1 x Rear Center Panel 2 x TLED-419CR 2 x TLED-4X40 5 x TLED-2HXRW 4 x TBEZ-4CH4 5 x TBEZ-2HCH4 4 x TGRO-4R 5 x TGRO-2HRO 1 x License Plate 2 x License LEDs 1 x Composite Back Plate	1 x Rear Center Panel 4 x TLED-4X40 5 x TLED-2HXRW 4 x TBEZ-4CH4 5 x TBEZ-2HCH4 4 x TGRO-4R 5 x TGRO-2HRO 1 x License Plate 2 x License LEDs 1 x Composite Back Plate	1 x Rear Center Panel 4 x TLED-4XRB 5 x TLED-2HXRW 4 x TBEZ-4CH4 5 x TBEZ-2HCH4 4 x TGRO-4R 5 x TGRO-2HRO 1 x License Plate 2 x License LEDs 1 x Composite Back Plate	1 x Rear Center Panel 4 x TLED-4XRP 5 x TLED-2HXRP 4 x TBEZ-4CH4 5 x TBEZ-2HCH4 4 x TGRO-4R 5 x TGRO-2HRO 1 x License Plate 2 x License LEDs 1 x Composite Back Plate	1 x Rear Center Panel 4 x TLED-4XRG 5 x TLED-2HXRG 4 x TBEZ-4CH4 5 x TBEZ-2HCH4 4 x TGRO-4R 5 x TGRO-2HRO 1 x License Plate 2 x License LEDs 1 x Composite Back Plate

UNIVERSAL ACCESSORIES

- 430 Mirror Shine Stainless Steel
- LED Lighting with Grommets & Bezels*
- License Plate Frame with License LEDs*

- Pre-Wired & Assembled*
- Aluminum Composite Back Plate
- Reinforced Brackets for Mounting Holes

*Applies to Specific Products

LED REAR CENTER PANELS - 4" ROUND STANDARD | DUAL REVOLUTION LEDS - STAINLESS STEEL

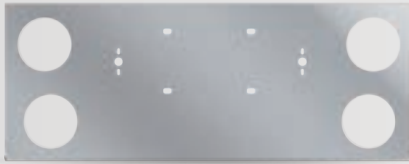

4 x 4" HOLES
TU-9017

**TOP
SELLER**



RED STOP, TURN & TAIL
TU-9017L1 Red Lens



RED STOP, TURN & TAIL
TU-9017LC Clear Lens



RED STOP, TURN & TAIL TO WHITE BACK UP
TU-9017L2 Clear Lens



RED STOP, TURN & TAIL TO WHITE BACK UP
TU-9017L4 Clear Lens



TECHNICAL SPECIFICATIONS

DOT/SAE	Compliant
FUNCTION	TU-9017L1/LC: Stop, Turn & Tail TU-9017L2/L4: Stop, Turn & Tail To Back Up
WARRANTY	1 Year

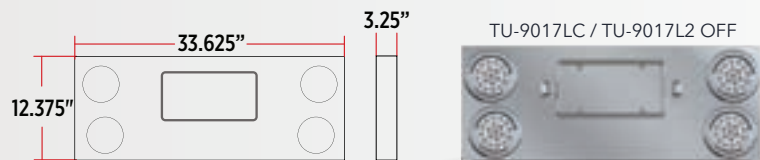

PART NUMBER	TU-9017	TU-9017L1	TU-9017LC	TU-9017L2	TU-9017L4
KIT INCLUDES	1 x Rear Center Panel 1 x Composite Back Plate	1 x Rear Center Panel 4 x TLED-48R 4 x TBEZ-4CH4 4 x TGRO-4R 1 x License Plate 2 x License LEDs 1 x Composite Back Plate	1 x Rear Center Panel 4 x TLED-48CR 4 x TBEZ-4CH4 4 x TGRO-4R 1 x License Plate 2 x License LEDs 1 x Composite Back Plate	1 x Rear Center Panel 4 x TLED-4X40 4 x TBEZ-4CH4 4 x TGRO-4R 1 x License Plate 2 x License LEDs 1 x Composite Back Plate	1 x Rear Center Panel 2 x TLED-4X40 2 x TLED-419CR 4 x TBEZ-4CH4 4 x TGRO-4R 1 x License Plate 2 x License LEDs 1 x Composite Back Plate

WARNING: Cancer and Reproductive Harm - www.p65warnings.ca.gov

LED REAR CENTER PANELS - OVAL & 2.5" STANDARD LEDS

STAINLESS STEEL



4 x OVAL HOLES & 4 x 2.5" HOLES
TU-9008



RED STOP, TURN & TAIL
TU-9008L Red Lens



RED STOP, TURN & TAIL
TU-9008LC Clear Lens

TECHNICAL SPECIFICATIONS

DOT/SAE	Compliant
FUNCTION	Stop, Turn & Tail
WARRANTY	1 Year

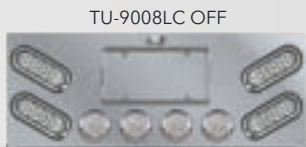
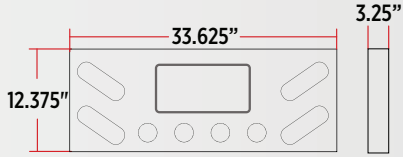

PART NUMBER	TU-9008	TU-9008L	TU-9008LC
KIT INCLUDES	1 x Rear Center Panel 1 x Composite Back Plate	1 x Rear Center Panel 4 x TLED-OBMR 4 x TLED-2HR 4 x TBEZ-OBCH4 4 x TBEZ-2HCH4 4 x TGRO-OBR 4 x TGRO-2HRO 1 x License Plate 1 x License LEDs 1 x Composite Back Plate	1 x Rear Center Panel 4 x TLED-OBMCR 4 x TLED-2HTR 4 x TBEZ-OBCH4 4 x TBEZ-2HCH4 4 x TGRO-OBR 4 x TGRO-2HRO 1 x License Plate 1 x License LEDs 1 x Composite Back Plate

LED REAR CENTER PANELS - 4" & 2" STANDARD LEDS

EXTRA WIDE - STAINLESS STEEL



RED STOP, TURN & TAIL
TU-9013L Red Lens



RED STOP, TURN & TAIL
TU-9013LC Clear Lens

TECHNICAL SPECIFICATIONS

DOT/SAE	Compliant
FUNCTION	Stop, Turn & Tail
WARRANTY	1 Year

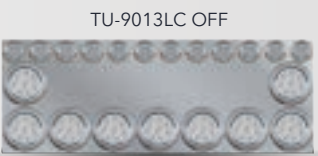
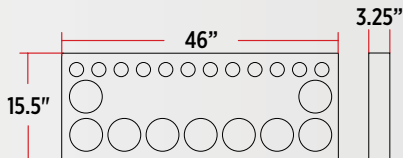

PART NUMBER	TU-9013L	TU-9013LC
KIT INCLUDES	1 x Rear Center Panel 9 x TLED-48R 12 x TLED-2R 9 x TBEZ-4CH4 12 x TBEZ-2CH4 9 x TGRO-4R 12 x TGRO-2R	1 x Rear Center Panel 9 x TLED-48CR 12 x TLED-2TR 9 x TBEZ-4CH4 12 x TBEZ-2CH4 9 x TGRO-4R 12 x TGRO-2R

UNIVERSAL ACCESSORIES

LED AIR LINE BOX - 4" & 2" STANDARD LEDS OPEN BACK - STAINLESS STEEL



▲
2 x 4" HOLES & 5 x 2" HOLES
TU-1601

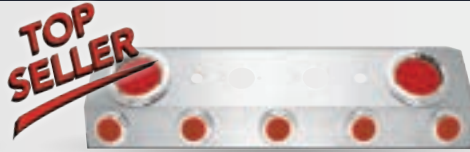

▲
RED STOP, TURN & TAIL
TU-1601L Red Lens



▲
RED STOP, TURN & TAIL
TU-1601LC Clear Lens

TECHNICAL SPECIFICATIONS

DOT/SAE	Compliant
FUNCTION	Stop, Turn & Tail
WARRANTY	1 Year

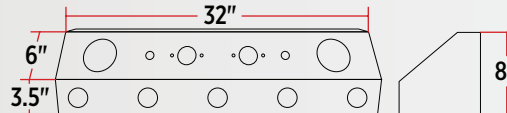

PART NUMBER	TU-1601	TU-1601L	TU-1601LC
KIT INCLUDES	1 x Air Line Box 1 x Bracket Kit All Hardware	1 x Air Line Box 1 x Bracket Kit 2 x TLED-48R 5 x TLED-2R 4 x TBEZ-4CH4 5 x TBEZ-2CH4 2 x TGRO-4R 5 x TGRO-2R All Hardware	1 x Air Line Box 1 x Bracket Kit 2 x TLED-48CR 5 x TLED-2TR 4 x TBEZ-4CH4 5 x TBEZ-2CH4 2 x TGRO-4R 5 x TGRO-2R All Hardware

TU-1601LC OFF



BRACKET KIT INCLUDED



⚠ WARNING: Cancer and Reproductive Harm - www.p65warnings.ca.gov

LED AIR LINE BOX - 4" & 2" DUAL REVOLUTION LEDS

OPEN BACK - STAINLESS STEEL



TECHNICAL SPECIFICATIONS

DOT/SAE	DOT to Auxiliary
FUNCTIONS	Stop, Turn & Tail to Auxiliary
WARRANTY	1 Year

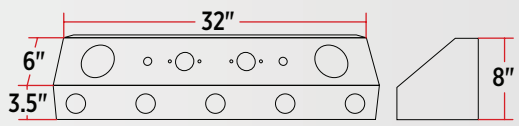

PART NUMBER	TU-1601L2	TU-1601L3	TU-1601L4	TU-1601L5
KIT INCLUDES	1 x Air Line Box 1 x Bracket Kit 2 x TLED-4X40 5 x TLED-2XRW 2 x TBEZ-4CH4 5 x TBEZ-2CH4 2 x TGRO-4R 5 x TGRO-2R All Hardware	1 x Air Line Box 1 x Bracket Kit 2 x TLED-4XRB 5 x TLED-2XRB 2 x TBEZ-4CH4 5 x TBEZ-2CH4 2 x TGRO-4R 5 x TGRO-2R All Hardware	1 x Air Line Box 1 x Bracket Kit 2 x TLED-4XRG 5 x TLED-2XRG 2 x TBEZ-4CH4 5 x TBEZ-2CH4 2 x TGRO-4R 5 x TGRO-2R All Hardware	1 x Air Line Box 1 x Bracket Kit 2 x TLED-4XRP 5 x TLED-2XRP 2 x TBEZ-4CH4 5 x TBEZ-2CH4 2 x TGRO-4R 5 x TGRO-2R All Hardware



▲ **WARNING: Cancer and Reproductive Harm - www.p65warnings.ca.gov**

UNIVERSAL ACCESSORIES

WEST COAST MIRRORS 7" WIDE x 16" HIGH - STAINLESS STEEL



▲
STANDARD
TM-2009



▲
HEATED
TM-2008



▲
HEATED WITH INCANDESCENT
TM-2011

TECHNICAL SPECIFICATIONS

PART NUMBER	TM-2009	TM-2008	TM-2011
WHAT'S INCLUDED	Mounting Hardware	1 x Heating Element Mounting Hardware	1 x Heating Element 1 x Incandescent Light Mounting Hardware
OPERATING VOLTAGE	N/A	12 Volts	12 Volts
SOLD	Individually	Individually	Individually
WARRANTY	1 Year	1 Year	1 Year

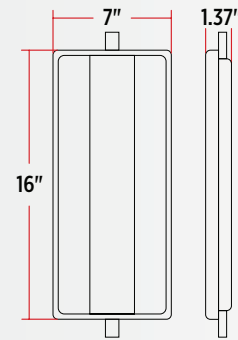

▲ WARNING: Cancer and Reproductive Harm - www.p65warnings.ca.gov

8" CONVEX MIRRORS

STAINLESS STEEL



NO LED
TM-2002 Center Mount



NO LED
TM-2003 Offset Mount

TECHNICAL SPECIFICATIONS

PART NUMBER	TM-2002	TM-2003
WHAT'S INCLUDED	L Bracket & Mounting Hardware	L Bracket & Mounting Hardware
SOLD	Individually	Individually
WARRANTY	1 Year	1 Year

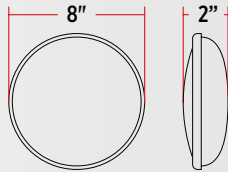

WARNING: Cancer and Reproductive Harm - www.p65warnings.ca.gov

FENDERS

24" TUBE MOUNT QUARTER FENDER KIT

**TOP
SELLER**



ROLLED EDGE
TFEN-Q17 18 Gauge

TECHNICAL SPECIFICATIONS

FENDER LENGTH	24"
MATERIAL	Stainless Steel
WEIGHT PER SET	25 lbs.
SOLD	As a Kit
WARRANTY	1 Year

KIT INCLUDES

2 x Fenders
2 x Tube Mounts
2 x Clamps
2 x Top Mud Flaps
& Hardware

TUBE MOUNT



18
GAUGE

SOLD AS A
KIT



WARNING: Cancer and Reproductive Harm - www.p65warnings.ca.gov

24" TRIANGLE MOUNT QUARTER FENDER KIT

**TOP
SELLER**



ROLLED EDGE
TFEN-Q10 16 Gauge

TECHNICAL SPECIFICATIONS

FENDER LENGTH	24"
MATERIAL	Stainless Steel
WEIGHT PER SET	25 lbs.
SOLD	As a Kit
WARRANTY	1 Year



KIT INCLUDES

- 2 x Fenders
- 2 x Triangle Mounts
- 2 x Clamps
- 2 x Top Mud Flaps & Hardware

TRIANGLE MOUNT



SOLD AS A
KIT

16
GAUGE

24" LOW TUBE MOUNT QUARTER FENDER KIT



OEM REPLACEMENT - ROLLED EDGE
TFEN-Q28 18 Gauge

TECHNICAL SPECIFICATIONS

FENDER LENGTH	24"
MATERIAL	Stainless Steel
WEIGHT PER SET	32 lbs.
SOLD	As a Kit
WARRANTY	1 Year



KIT INCLUDES

- 2 x Fenders
- 2 x Tube Mounts
- 2 x Clamps
- 2 x Top Mud Flaps & Hardware

TUBE MOUNT



SOLD AS A
KIT

18
GAUGE

24" LOW TUBE MOUNT MID BRACED - QUARTER FENDER KIT



OEM REPLACEMENT - ROLLED EDGE
TFEN-Q25 18 Gauge

TECHNICAL SPECIFICATIONS

FENDER LENGTH	24"
MATERIAL	Stainless Steel
WEIGHT PER SET	32 lbs.
SOLD	As a Kit
WARRANTY	1 Year



KIT INCLUDES

- 2 x Fenders
- 2 x Tube Mounts
- 2 x Clamps
- 2 x Top Mud Flaps & Hardware

TUBE MOUNT



SOLD AS A
KIT

18
GAUGE

24" MID TUBE MOUNT DOUBLE BRACED - QUARTER FENDER KIT



OEM REPLACEMENT - ROLLED EDGE
TFEN-Q26 18 Gauge

TECHNICAL SPECIFICATIONS

FENDER LENGTH	24"
MATERIAL	Stainless Steel
WEIGHT PER SET	32 lbs.
SOLD	As a Kit
WARRANTY	1 Year



KIT INCLUDES

- 2 x Fenders
- 2 x Tube Mounts
- 2 x Clamps
- 2 x Top Mud Flaps & Hardware

TUBE MOUNT



SOLD AS A
KIT

18
GAUGE

WARNING: Cancer and Reproductive Harm - www.p65warnings.ca.gov

FENDERS

27" TRIANGLE MOUNT QUARTER FENDER KIT

**TOP
SELLER**



ROLLED EDGE

TFEN-Q11 16 Gauge

TECHNICAL SPECIFICATIONS

FENDER LENGTH	27"
MATERIAL	Stainless Steel
WEIGHT PER SET	30 lbs.
SOLD	As a Kit
WARRANTY	1 Year



KIT INCLUDES

- 2 x Fenders
- 2 x Triangle Mounts
- 2 x Clamps
- 2 x Top Mud Flaps & Hardware

TRIANGLE MOUNT



SOLD AS A
KIT

16
GAUGE



31" TRIANGLE MOUNT LONG STRAIGHT DROP QUARTER FENDER KIT



STRAIGHT DROP - ROLLED EDGE

TFEN-Q14 16 Gauge

TECHNICAL SPECIFICATIONS

FENDER LENGTH	31"
MATERIAL	Stainless Steel
WEIGHT PER SET	43 lbs.
SOLD	As a Kit
WARRANTY	1 Year



KIT INCLUDES

- 2 x Fenders
- 2 x Triangle Mounts
- 2 x Clamps
- 2 x Top Mud Flaps & Hardware

TRIANGLE MOUNT



SOLD AS A
KIT

16
GAUGE

34" TRIANGLE MOUNT LONG STRAIGHT DROP QUARTER FENDER KIT



LONG STRAIGHT DROP - ROLLED EDGE

TFEN-Q13 16 Gauge

TECHNICAL SPECIFICATIONS

FENDER LENGTH	34"
MATERIAL	Stainless Steel
WEIGHT PER SET	46 lbs.
SOLD	As a Kit
WARRANTY	1 Year



KIT INCLUDES

- 2 x Fenders
- 2 x Triangle Mounts
- 2 x Clamps
- 2 x Top Mud Flaps & Hardware

TRIANGLE MOUNT



SOLD AS A
KIT

16
GAUGE

WARNING: Cancer and Reproductive Harm - www.p65warnings.ca.gov

38" TRIANGLE MOUNT LOW RIDER - QUARTER FENDER KIT



STRAIGHT DROP - ROLLED EDGE
TFEN-Q21 14 Gauge

TECHNICAL SPECIFICATIONS

FENDER LENGTH	38"
MATERIAL	Stainless Steel
WEIGHT PER SET	58 lbs.
SOLD	As a Kit
WARRANTY	1 Year

KIT INCLUDES

- 2 x Fenders
- 2 x Triangle Mounts
- 2 x Clamps
- 2 x Top Mud Flaps & Hardware

TRIANGLE MOUNT



SOLD AS A
KIT

14
GAUGE

38" TRIANGLE MOUNT ROLLIN' LO - QUARTER FENDER KIT



LONG CURVED DROP - ROLLED EDGE
TFEN-Q12 14 Gauge

TECHNICAL SPECIFICATIONS

FENDER LENGTH	38"
MATERIAL	Stainless Steel
WEIGHT PER SET	58 lbs.
SOLD	As a Kit
WARRANTY	1 Year

KIT INCLUDES

- 2 x Fenders
- 2 x Triangle Mounts
- 2 x Clamps
- 2 x Top Mud Flaps & Hardware

TRIANGLE MOUNT



SOLD AS A
KIT

14
GAUGE

JOIN TRUX'S STAINLESS FENDER PROGRAM AND RECIEVE A FREE DISPLAY!

CONTACT YOUR TRUX ACCOUNT MANAGER TODAY!



STARTER

TRX-168

'STARTER' FENDER DISPLAY
RETAIL SPACE: 36" X 24" X 47"



STANDARD

TRX-167

'STANDARD' FENDER DISPLAY
RETAIL SPACE: 36" X 24" X 47"



PREMIUM

TRX-113

'PREMIUM' FENDER DISPLAY
RETAIL SPACE: 43" x 48" x 92"

WARNING: Cancer and Reproductive Harm - www.p65warnings.ca.gov

FENDERS

60" SMOOTH FLANGED HALF FENDERS

**TOP
SELLER**

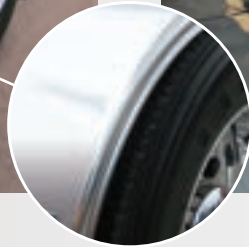

FLANGE

ROLLED EDGE WITH FLANGE
TFEN-H12 16 Gauge

TECHNICAL SPECIFICATIONS

FENDER LENGTH	60"
MATERIAL	Stainless Steel
WEIGHT PER SET	55 lbs.
SOLD	As a Pair
WARRANTY	1 Year

DESIGNED TO FIT	43.5"/46.5" O.D TIRES
-----------------	------------------------------

Trux recommends installing with Mounting Kits that are the SAME OR THICKER Gauge than the fender.
TFEN-HKIT, TFEN-HKITN, TFEN-HKITHD, TFEN-HKIT2 or TFEN-HKIT2HD (Page 171)

**16
GAUGE**
**SOLD AS A
PAIR**

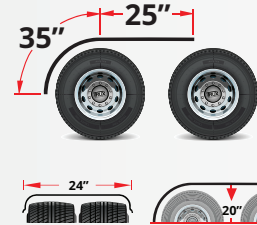

60" SMOOTH HEAVY DUTY - HALF FENDERS



ROLLED EDGE
TFEN-H59 14 Gauge

TECHNICAL SPECIFICATIONS

FENDER LENGTH	60"
MATERIAL	Stainless Steel
WEIGHT PER SET	69 lbs.
SOLD	As a Pair
WARRANTY	1 Year
DESIGNED TO FIT	43.5"/46.5" O.D TIRES

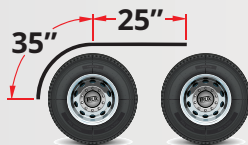

**14
GAUGE** **SOLD AS A
PAIR**

Trux recommends installing with Mounting Kits that are the SAME OR THICKER Gauge than the fender. **TFEN-HKITHD or TFEN-HKIT2HD** (Page 171)

66" SMOOTH STANDARD | HEAVY DUTY - HALF FENDERS



ROLLED EDGE
TFEN-H55 16 Gauge
TFEN-H61 14 Gauge

TECHNICAL SPECIFICATIONS

FENDER LENGTH	66"
MATERIAL	Stainless Steel
SOLD	As a Pair
WEIGHT PER SET	TFEN-H55: 61 lbs. TFEN-H61: 76 lbs.
WARRANTY	1 Year
DESIGNED TO FIT	43.5"/46.5" O.D TIRES

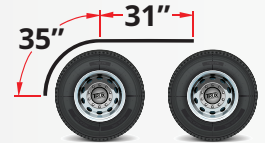

TFEN-H55
**16
GAUGE** **TFEN-H61**
**14
GAUGE**

Trux recommends installing with Mounting Kits that are the SAME OR THICKER Gauge from the fender. TFEN-H55: **TFEN-HKIT, TFEN-HKITN, TFEN-HKITHD, TFEN-HKIT2 or TFEN-HKIT2HD** (Page 171) TFEN-H61: **TFEN-HKITHD or TFEN-HKIT2HD** (Page 171)

**SOLD AS A
PAIR**

WARNING: Cancer and Reproductive Harm - www.p65warnings.ca.gov

66" SMOOTH FLANGED HALF FENDERS



ROLLED EDGE WITH FLANGE
TFEN-H13 16 Gauge

FLANGE

TECHNICAL SPECIFICATIONS

FENDER LENGTH	66"
MATERIAL	Stainless Steel
WEIGHT PER SET	61 lbs.
SOLD	As a Pair
WARRANTY	1 Year

DESIGNED TO FIT **43.5"/46.5" O.D TIRES**
Trux recommends installing with Mounting Kits that are the SAME OR THICKER Gauge than the fender.
TFEN-HKIT, TFEN-HKITN, TFEN-HKITHD, TFEN-HKIT2 or TFEN-HKIT2HD (Page 171)

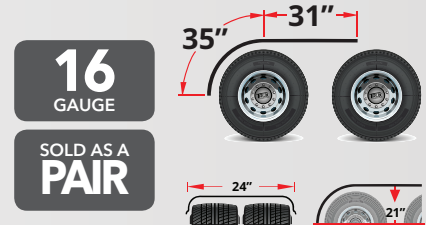

16 GAUGE
SOLD AS A PAIR

66" SMOOTH LOW PROFILE STANDARD | HEAVY DUTY - HALF FENDERS



ROLLED EDGE
TFEN-H21 16 Gauge
TFEN-H20 14 Gauge

TECHNICAL SPECIFICATIONS

FENDER LENGTH	66"
MATERIAL	Stainless Steel
WEIGHT PER SET	TFEN-H21: 61 lbs. TFEN-H20: 76 lbs.
SOLD	As a Pair
WARRANTY	1 Year
DESIGNED TO FIT	41.75" O.D TIRES

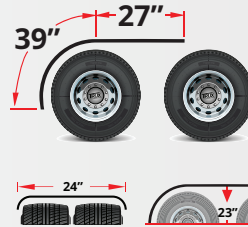

TFEN-H21
16 GAUGE
TFEN-H20
14 GAUGE
SOLD AS A PAIR

Trux recommends installing with Mounting Kits that are the SAME OR THICKER Gauge than the fender. TFEN-H21: **TFEN-HKIT, TFEN-HKITN, TFEN-HKITHD, TFEN-HKIT2 or TFEN-HKIT2HD** (Page 171) TFEN-H20: **TFEN-HKIT2HD or TFEN-HKIT2HD** (Page 171)

66" SMOOTH LONG FRONT STANDARD | HEAVY DUTY - HALF FENDERS



ROLLED EDGE
TFEN-H15 16 Gauge
TFEN-H54 14 Gauge

TECHNICAL SPECIFICATIONS

FENDER LENGTH	66"
MATERIAL	Stainless Steel
WEIGHT PER SET	TFEN-H15: 61 lbs. TFEN-H54: 76 lbs.
SOLD	As a Pair
WARRANTY	1 Year
DESIGNED TO FIT	43.5"/46.5" O.D TIRES

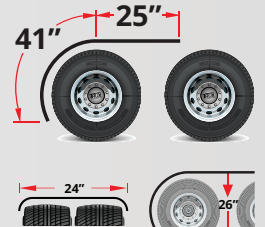

TFEN-H15
16 GAUGE
TFEN-H54
14 GAUGE
SOLD AS A PAIR

Trux recommends installing with Mounting Kits that are the SAME OR THICKER Gauge than the fender. TFEN-H15: **TFEN-HKIT, TFEN-HKITN, TFEN-HKITHD, TFEN-HKIT2 or TFEN-HKIT2HD** (Page 171) TFEN-H54: **TFEN-HKIT2HD or TFEN-HKIT2HD** (Page 171)

FENDERS

72" SMOOTH LONG FRONT HALF FENDERS

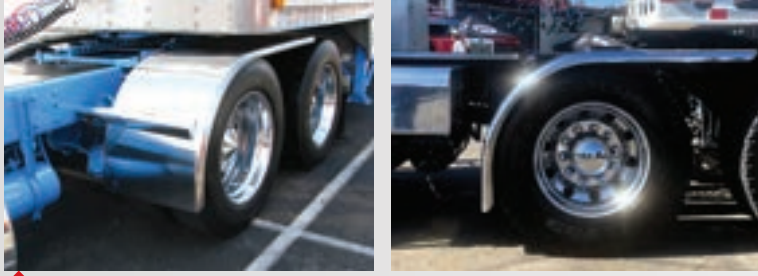

ROLLED EDGE
TFEN-H16 16 Gauge
TFEN-H50 14 Gauge

TECHNICAL SPECIFICATIONS

FENDER LENGTH	72"
MATERIAL	Stainless Steel
WEIGHT PER SET	TFEN-H16: 66 lbs. TFEN-H50: 83 lbs.
SOLD	As a Pair
WARRANTY	1 Year
DESIGNED TO FIT	43.5"/46.5" O.D TIRES

Trux recommends installing with Mounting Kits that are the SAME OR THICKER Gauge than the fender. TFEN-H16: **TFEN-HKIT, TFEN-HKITN, TFEN-HKITHD, TFEN-HKIT2 or TFEN-HKIT2HD** (Page 171)
 TFEN-H50: **TFEN-HKITHD or TFEN-HKIT2HD** (Page 171)

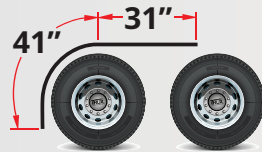

TFEN-H16
16
 GAUGE

TFEN-H50
14
 GAUGE

SOLD AS A PAIR

80" SMOOTH FLANGED HALF FENDERS

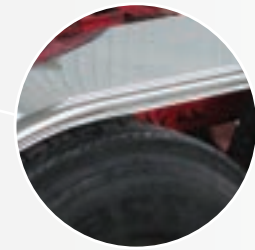

FLANGE

ROLLED EDGE WITH FLANGE
TFEN-H14 16 Gauge

TECHNICAL SPECIFICATIONS

FENDER LENGTH	80"
MATERIAL	Stainless Steel
WEIGHT PER SET	80 lbs.
SOLD	As a Pair
WARRANTY	1 Year
DESIGNED TO FIT	43.5"/46.5" O.D TIRES

Trux recommends installing with Mounting Kits that are the SAME OR THICKER Gauge than the fender. **TFEN-HKIT, TFEN-HKITN, TFEN-HKITHD, TFEN-HKIT2 or TFEN-HKIT2HD** (Page 171)

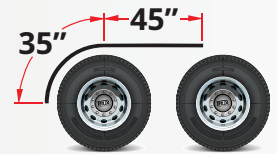

16
 GAUGE

SOLD AS A PAIR



WARNING: Cancer and Reproductive Harm - www.p65warnings.ca.gov

80" SMOOTH ROLLIN' LO - HALF FENDERS



ROLLED EDGE

TFEN-H10 16 Gauge
TFEN-H52 14 Gauge

TECHNICAL SPECIFICATIONS

FENDER LENGTH	80"
MATERIAL	Stainless Steel
WEIGHT PER SET	TFEN-H10: 74 lbs. TFEN-H52: 92 lbs.
SOLD	As a Pair
WARRANTY	1 Year
DESIGNED TO FIT	43.5"/46.5" O.D TIRES

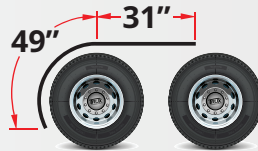

TFEN-H10
16
GAUGE

TFEN-H52
14
GAUGE

**SOLD AS A
PAIR**

Trux recommends installing with Mounting Kits that are the SAME OR THICKER Gauge than the fender. **TFEN-HKIT, TFEN-HKITN, TFEN-HKITHD, TFEN-HKIT2 or TFEN-HKIT2HD** (Page 171)

80" SMOOTH LOW PROFILE ROLLIN' LO - HALF FENDERS



ROLLED EDGE

TFEN-H11 16 Gauge
TFEN-H53 14 Gauge

TECHNICAL SPECIFICATIONS

FENDER LENGTH	80"
MATERIAL	Stainless Steel
WEIGHT PER SET	TFEN-H11: 74 lbs. TFEN-H53: 92 lbs.
SOLD	As a Pair
WARRANTY	1 Year
DESIGNED TO FIT	41.75" O.D TIRES

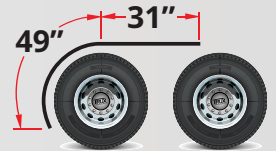

TFEN-H11
16
GAUGE

TFEN-H53
14
GAUGE

**SOLD AS A
PAIR**

Trux recommends installing with Mounting Kits that are the SAME OR THICKER Gauge than the fender. **TFEN-H11: TFEN-HKIT, TFEN-HKITN, TFEN-HKITHD, TFEN-HKIT2 or TFEN-HKIT2HD** (Page 171) **TFEN-H53: TFEN-HKITHD or TFEN-HKIT2HD** (Page 171)



80" SMOOTH STRAIGHT DROP LOW RIDER - HALF FENDERS



ROLLED EDGE

TFEN-H57 14 Gauge

TECHNICAL SPECIFICATIONS

FENDER LENGTH	80"
MATERIAL	Stainless Steel
WEIGHT PER SET	92 lbs.
SOLD	As a Pair
WARRANTY	1 Year
DESIGNED TO FIT	43.5"/46.5" O.D TIRES

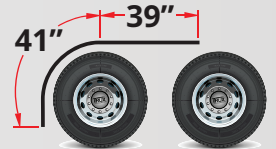

14
GAUGE

**SOLD AS A
PAIR**

Trux recommends installing with Mounting Kits that are the SAME OR THICKER Gauge than the fender. **TFEN-HKITHD or TFEN-HKIT2HD** (Page 171)

FENDERS

60" 4 RIBBED HALF FENDERS



BEADED EDGE
TFEN-H32 16 Gauge

TECHNICAL SPECIFICATIONS

FENDER LENGTH	60"
MATERIAL	Stainless Steel
WEIGHT PER SET	52 lbs.
SOLD	As a Pair
WARRANTY	1 Year
DESIGNED TO FIT	43.5" O.D TIRES

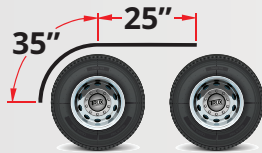

16
GAUGE

SOLD AS A
PAIR

Trux recommends installing with Mounting Kits that are the SAME OR THICKER Gauge than the fender. **TFEN-HKIT**, **TFEN-HKITN**, **TFEN-HKITHD**, **TFEN-HKIT2** or **TFEN-HKIT2HD** (Page 171)

66" 4 RIBBED HALF FENDERS



BEADED EDGE
TFEN-H34 Stainless Steel
TFEN-H35 Galvanized Steel

TECHNICAL SPECIFICATIONS

FENDER LENGTH	66"
GAUGE	16 ga.
WEIGHT PER SET	TFEN-H34: 45 lbs. TFEN-H35: 59 lbs.
SOLD	As a Pair
WARRANTY	1 Year
DESIGNED TO FIT	43.5" O.D TIRES

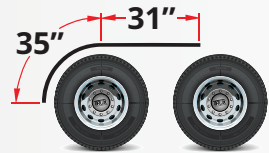

16
GAUGE

SOLD AS A
PAIR

Trux recommends installing with Mounting Kits that are the SAME OR THICKER Gauge than the fender. **TFEN-HKIT**, **TFEN-HKITN**, **TFEN-HKITHD**, **TFEN-HKIT2** or **TFEN-HKIT2HD** (Page 171)

80" 4 RIBBED HALF FENDERS



BEADED EDGE
TFEN-H37 Stainless Steel
TFEN-H38 Galvanized Steel

TECHNICAL SPECIFICATIONS

FENDER LENGTH	80"
GAUGE	16 ga.
WEIGHT PER SET	TFEN-H37: 72 lbs. TFEN-H38: 64 lbs.
SOLD	As a Pair
WARRANTY	1 Year
DESIGNED TO FIT	43.5" O.D TIRES

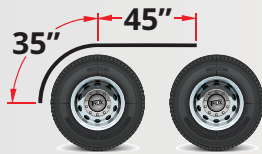

16
GAUGE

SOLD AS A
PAIR

Trux recommends installing with Mounting Kits that are the SAME OR THICKER Gauge than the fender. **TFEN-HKIT**, **TFEN-HKITN**, **TFEN-HKITHD**, **TFEN-HKIT2** or **TFEN-HKIT2HD** (Page 171)

**CAN'T FIND WHAT
YOU'RE LOOKING FOR?**

**WITH OVER 2000 MORE
PRODUCTS ON OUR WEBSITE,
YOU'D BE SURE TO FIND WHAT YOU WANT!**



**VISIT OUR WEBSITE
TRUXACCESSORIES.COM**

WARNING: Cancer and Reproductive Harm - www.p65warnings.ca.gov

60" 3 RIBBED HALF FENDERS



ROLLED EDGE
TFEN-H27 16 Gauge

TECHNICAL SPECIFICATIONS

FENDER LENGTH	60"
MATERIAL	Stainless Steel
WEIGHT PER SET	55 lbs.
SOLD	As a Pair
WARRANTY	1 Year
DESIGNED TO FIT	43.5"/46.5" O.D TIRES

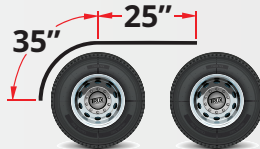

16
GAUGE

**SOLD AS A
PAIR**

Trux recommends installing with Mounting Kits that are the SAME OR THICKER Gauge than the fender. **TFEN-HKIT, TFEN-HKITN, TFEN-HKITHD, TFEN-HKIT2 or TFEN-HKIT2HD** (Page 171)

66" 3 RIBBED HALF FENDERS



ROLLED EDGE
TFEN-H29 16 Gauge

TECHNICAL SPECIFICATIONS

FENDER LENGTH	66"
MATERIAL	Stainless Steel
WEIGHT PER SET	61 lbs.
SOLD	As a Pair
WARRANTY	1 Year
DESIGNED TO FIT	43.5"/46.5" O.D TIRES

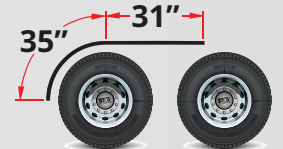

16
GAUGE

**SOLD AS A
PAIR**

Trux recommends installing with Mounting Kits that are the SAME OR THICKER Gauge than the fender. **TFEN-HKIT, TFEN-HKITN, TFEN-HKITHD, TFEN-HKIT2 or TFEN-HKIT2HD** (Page 171)

72" 3 RIBBED HALF FENDERS



ROLLED EDGE
TFEN-H31 16 Gauge

TECHNICAL SPECIFICATIONS

FENDER LENGTH	72"
MATERIAL	Stainless Steel
WEIGHT PER SET	66 lbs.
SOLD	As a Pair
WARRANTY	1 Year
DESIGNED TO FIT	43.5"/46.5" O.D TIRES

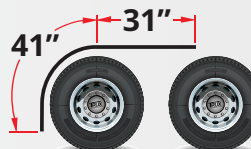

16
GAUGE

**SOLD AS A
PAIR**

Trux recommends installing with Mounting Kits that are the SAME OR THICKER Gauge than the fender. **TFEN-HKIT, TFEN-HKITN, TFEN-HKITHD, TFEN-HKIT2 or TFEN-HKIT2HD** (Page 171)

125" 3 RIBBED HALF FENDERS



ROLLED EDGE
TFEN-H24 16 Gauge

TECHNICAL SPECIFICATIONS

FENDER LENGTH	125"
MATERIAL	Stainless Steel
WEIGHT PER SET	116 lbs.
SOLD	As a Pair
WARRANTY	1 Year
DESIGNED TO FIT	43.5"/46.5" O.D TIRES

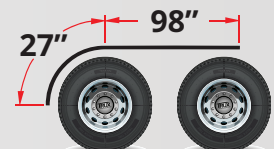

16
GAUGE

**SOLD AS A
PAIR**

Trux recommends installing with Mounting Kits that are the SAME OR THICKER Gauge than the fender. **TFEN-HKIT, TFEN-HKITN, TFEN-HKITHD, TFEN-HKIT2 or TFEN-HKIT2HD** (Page 171)

FENDERS

144" 3 RIBBED HALF FENDERS



▲
ROLLED EDGE
TFEN-H63 16 Gauge

TECHNICAL SPECIFICATIONS

FENDER LENGTH	144"
MATERIAL	Stainless Steel
WEIGHT PER SET	134 lbs.
SOLD	As a Pair
WARRANTY	1 Year

DESIGNED TO FIT	43.5"/46.5" O.D TIRES
-----------------	------------------------------

Trux recommends installing with Mounting Kits that are the SAME OR THICKER Gauge than the fender.
TFEN-HKIT, TFEN-HKITN, TFEN-HKITHD, TFEN-HKIT2 or TFEN-HKIT2HD (Page 171)

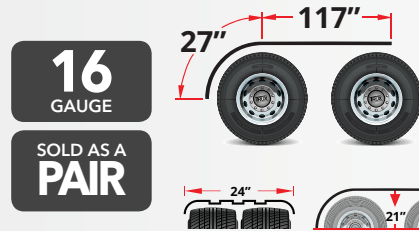

BEST PACKAGED FENDERS IN THE INDUSTRY

- FENDERS **WRAPPED WITH NYLON REINFORCED PACKAGING**
- FENDER CORNERS **GUARDED WITH PLASTIC PROTECTORS**
- FENDERS **STRAPPED DOWN TO SKIDS**
- FENDERS ALWAYS **WELL POSITIONED WITHIN EACH SKID**

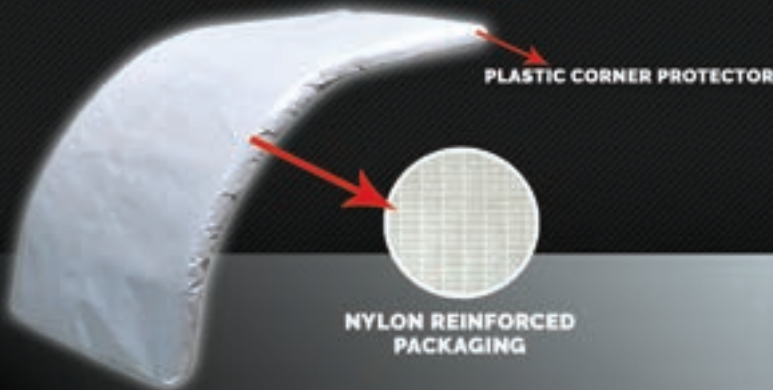

⚠️ **WARNING: Cancer and Reproductive Harm - www.p65warnings.ca.gov**

132" SMOOTH FULL FENDERS

TOP SELLER



ROLLED EDGE
TFEN-F12 16 Gauge
TFEN-F11 14 Gauge

TECHNICAL SPECIFICATIONS

FENDER LENGTH	132"
MATERIAL	Stainless Steel
WEIGHT PER SET	TFEN-F11: 152 lbs. TFEN-F12: 122 lbs.
SOLD	As a Pair
WARRANTY	1 Year

DESIGNED TO FIT	43.5" O.D TIRES
-----------------	------------------------

Trux recommends installing with Mounting Kits that are the SAME OR THICKER Gauge than the fender.
 TFEN-F12: **TFEN-FKIT, TFEN-FKITN, TFEN-FKITHD, TFEN-FKIT2** or **TFEN-FKIT2HD** (Page 171)
 TFEN-F11: **TFEN-FKITHD** or **TFEN-FKIT2HD** (Page 171)

TFEN-F12
16 GAUGE

TFEN-F11
14 GAUGE

SOLD AS A PAIR

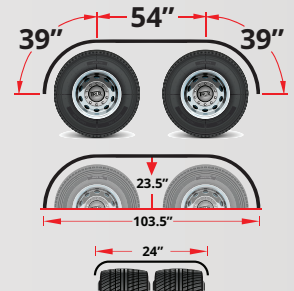

132" SMOOTH LOW PROFILE FULL FENDERS



ROLLED EDGE
TFEN-F34 14 Gauge

TECHNICAL SPECIFICATIONS

FENDER LENGTH	132"
MATERIAL	Stainless Steel
WEIGHT PER SET	152 lbs.
SOLD	As a Pair
WARRANTY	1 Year
DESIGNED TO FIT	41.75" O.D TIRES

Trux recommends installing with Mounting Kits that are the SAME OR THICKER Gauge than the fender.
TFEN-FKITHD or **TFEN-FKIT2HD** (Page 171)

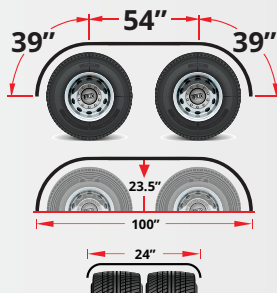

14 GAUGE

SOLD AS A PAIR

132" SMOOTH 60" AXLE SPREAD FULL FENDERS



ROLLED EDGE
TFEN-F14 14 Gauge

TECHNICAL SPECIFICATIONS

FENDER LENGTH	132"
MATERIAL	Stainless Steel
WEIGHT PER SET	152 lbs.
SOLD	As a Pair
WARRANTY	1 Year
DESIGNED TO FIT	43.5" O.D TIRES

Trux recommends installing with Mounting Kits that are the SAME OR THICKER Gauge than the fender.
TFEN-FKITHD or **TFEN-FKIT2HD** (Page 171)

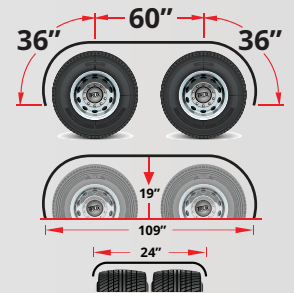

14 GAUGE

SOLD AS A PAIR

WARNING: Cancer and Reproductive Harm - www.p65warnings.ca.gov

FENDERS

108" SMOOTH FULL FENDERS

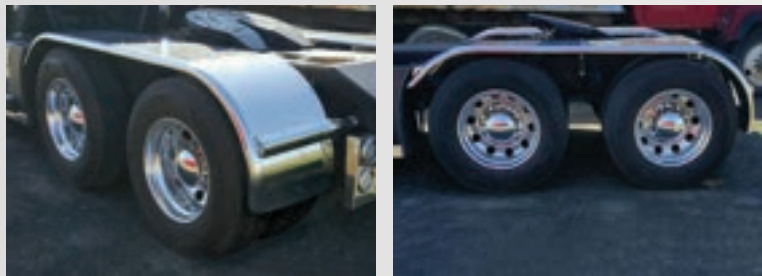

ROLLED EDGE

TFEN-F41 16 Gauge

TECHNICAL SPECIFICATIONS

FENDER LENGTH	108"
MATERIAL	Stainless Steel
WEIGHT PER SET	101 lbs.
SOLD	As a Pair
WARRANTY	1 Year

DESIGNED TO FIT **43.5" O.D TIRES**

Trux recommends installing with Mounting Kits that are the SAME OR THICKER Gauge than the fender. TFEN-FKIT, TFEN-FKITN, TFEN-FKITHD, TFEN-FKIT2 or TFEN-FKIT2HD (Page 171)

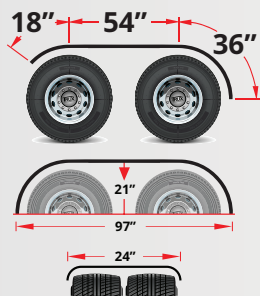

16
GAUGE

SOLD AS A
PAIR

120" SMOOTH FULL FENDERS



ROLLED EDGE

TFEN-F13 16 Gauge

TECHNICAL SPECIFICATIONS

FENDER LENGTH	120"
MATERIAL	Stainless Steel
WEIGHT PER SET	111 lbs.
SOLD	As a Pair
WARRANTY	1 Year

DESIGNED TO FIT **43.5" O.D TIRES**

Trux recommends installing with Mounting Kits that are the SAME OR THICKER Gauge than the fender. TFEN-FKIT, TFEN-FKITN, TFEN-FKITHD, TFEN-FKIT2 or TFEN-FKIT2HD (Page 171)

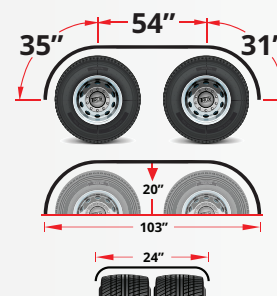

16
GAUGE

SOLD AS A
PAIR

142" SMOOTH STRAIGHT DROP - 'THE BOSS' - FULL FENDERS

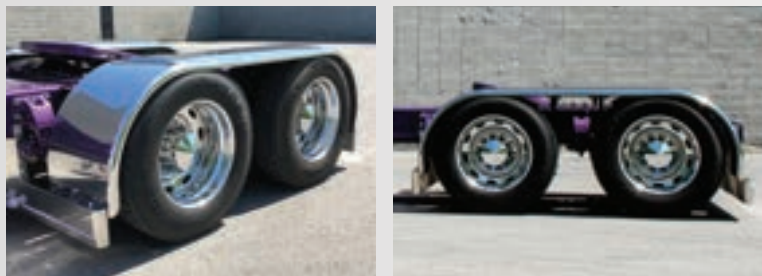

ROLLED EDGE

TFEN-F10 14 Gauge

TECHNICAL SPECIFICATIONS

FENDER LENGTH	142"
MATERIAL	Stainless Steel
WEIGHT PER SET	163 lbs.
SOLD	As a Pair
WARRANTY	1 Year

DESIGNED TO FIT **43.5" O.D TIRES**

Trux recommends installing with Mounting Kits that are the SAME OR THICKER Gauge than the fender. TFEN-FKITHD or TFEN-FKIT2HD (Page 171)

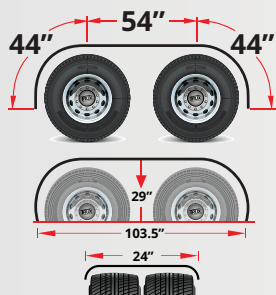

14
GAUGE

SOLD AS A
PAIR

142" SMOOTH LOW PROFILE STRAIGHT DROP - 'THE BOSS' - FULL FENDERS



ROLLED EDGE

TFEN-F33 14 Gauge

TECHNICAL SPECIFICATIONS

FENDER LENGTH	142"
MATERIAL	Stainless Steel
WEIGHT PER SET	163 lbs.
SOLD	As a Pair
WARRANTY	1 Year

DESIGNED TO FIT **41.75" O.D TIRES**

Trux recommends installing with Mounting Kits that are the SAME OR THICKER Gauge than the fender. TFEN-FKITHD or TFEN-FKIT2HD (Page 171)

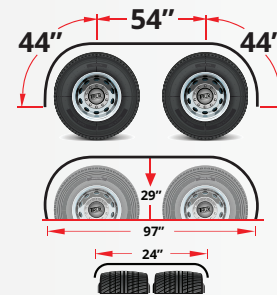

14
GAUGE

SOLD AS A
PAIR

WARNING: Cancer and Reproductive Harm - www.p65warnings.ca.gov

120" 4 RIBBED FULL FENDERS



BEADED EDGE

TFEN-F21 16 Gauge

TECHNICAL SPECIFICATIONS

FENDER LENGTH	120"
MATERIAL	Stainless Steel
WEIGHT PER SET	102 lbs.
SOLD	As a Pair
WARRANTY	1 Year
DESIGNED TO FIT	43.5" O.D TIRES

Trux recommends installing with Mounting Kits that are the SAME OR THICKER Gauge than the fender. TFEN-FKIT, TFEN-FKITN, TFEN-FKITHD, TFEN-FKIT2 or TFEN-FKIT2HD (Page 171)

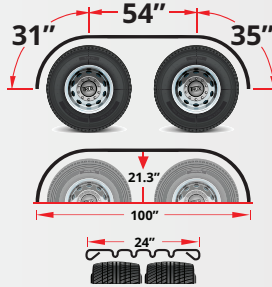

16
GAUGE

SOLD AS A
PAIR

116" 4 RIBBED FULL FENDERS



BEADED EDGE

TFEN-F37 16 Gauge

TECHNICAL SPECIFICATIONS

FENDER LENGTH	116"
MATERIAL	Stainless Steel
WEIGHT PER SET	106 lbs.
SOLD	As a Pair
WARRANTY	1 Year
DESIGNED TO FIT	46.5" O.D TIRES

Trux recommends installing with Mounting Kits that are the SAME OR THICKER Gauge than the fender. TFEN-FKIT, TFEN-FKITN, TFEN-FKITHD, TFEN-FKIT2 or TFEN-FKIT2HD (Page 171)

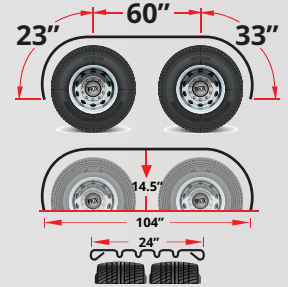

16
GAUGE

SOLD AS A
PAIR

108" 3 RIBBED FULL FENDERS



ROLLED EDGE

TFEN-F15 16 Gauge

TECHNICAL SPECIFICATIONS

FENDER LENGTH	108"
MATERIAL	Stainless Steel
WEIGHT PER SET	101 lbs.
SOLD	As a Pair
WARRANTY	1 Year
DESIGNED TO FIT	43.5" O.D TIRES

Trux recommends installing with Mounting Kits that are the SAME OR THICKER Gauge than the fender. TFEN-FKIT, TFEN-FKITN, TFEN-FKITHD, TFEN-FKIT2 or TFEN-FKIT2HD (Page 171)

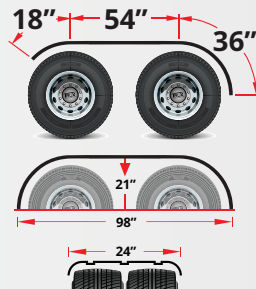

16
GAUGE

SOLD AS A
PAIR

120" 3 RIBBED FULL FENDERS



ROLLED EDGE

TFEN-F17 16 Gauge

TECHNICAL SPECIFICATIONS

FENDER LENGTH	120"
MATERIAL	Stainless Steel
WEIGHT PER SET	112 lbs.
SOLD	As a Pair
WARRANTY	1 Year
DESIGNED TO FIT	43.5" O.D TIRES

Trux recommends installing with Mounting Kits that are the SAME OR THICKER Gauge than the fender. TFEN-FKIT, TFEN-FKITN, TFEN-FKITHD, TFEN-FKIT2 or TFEN-FKIT2HD (Page 171)

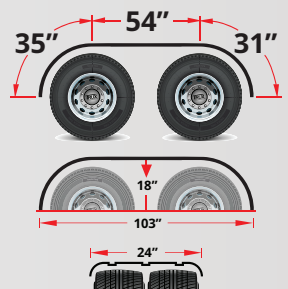

16
GAUGE

SOLD AS A
PAIR

FENDERS

80" SMOOTH SINGLE AXLE FENDERS



ROLLED EDGE
TFEN-S13 16 Gauge
TFEN-S12 14 Gauge

TECHNICAL SPECIFICATIONS

FENDER LENGTH	80"
MATERIAL	Stainless Steel
WEIGHT PER SET	TFEN-S13: 74 lbs. TFEN-S12: 92 lbs.
SOLD	As a Pair
WARRANTY	1 Year

DESIGNED TO FIT	43.5" O.D TIRES
-----------------	-----------------

Trux recommends installing with Mounting Kits that are the SAME OR THICKER Gauge than the fender.
 TFEN-S13: **TFEN-SKIT**, **TFEN-SKITN** or **TFEN-SKITHD** (Page 172) TFEN-S12: **TFEN-SKITHD** (Page 172)

TFEN-S13
16
 GAUGE

TFEN-S12
14
 GAUGE

SOLD AS A
PAIR

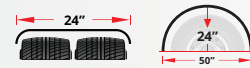
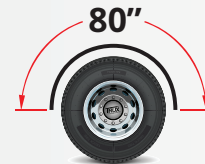

80" SMOOTH LOW PROFILE SINGLE AXLE FENDERS



ROLLED EDGE
TFEN-S33 16 Gauge
TFEN-S32 14 Gauge

TECHNICAL SPECIFICATIONS

FENDER LENGTH	80"
MATERIAL	Stainless Steel
WEIGHT PER SET	TFEN-S33: 74 lbs. TFEN-S32: 92 lbs.
SOLD	As a Pair
WARRANTY	1 Year
DESIGNED TO FIT	41.75" O.D TIRES



TFEN-S33
16
 GAUGE

TFEN-S32
14
 GAUGE

SOLD AS A
PAIR

Trux recommends installing with Mounting Kits that are the SAME OR THICKER Gauge than the fender. TFEN-S33: **TFEN-SKIT**, **TFEN-SKITN**, **TFEN-SKITHD** (Page 172) TFEN-S32: **TFEN-SKITHD** (Page 172)

91" SMOOTH CURVED DROP ROLLIN' LO - SINGLE AXLE FENDERS



ROLLED EDGE
TFEN-S11 14 Gauge

TECHNICAL SPECIFICATIONS

FENDER LENGTH	91"
MATERIAL	Stainless Steel
WEIGHT PER SET	105 lbs.
SOLD	As a Pair
WARRANTY	1 Year
DESIGNED TO FIT	41.75" O.D TIRES



14
 GAUGE

SOLD AS A
PAIR

Trux recommends installing with Mounting Kits that are the SAME OR THICKER Gauge than the fender. **TFEN-SKITHD** (Page 172)

WARNING: Cancer and Reproductive Harm - www.p65warnings.ca.gov

80" 3 RIBBED SINGLE AXLE FENDERS



ROLLED EDGE
TFEN-S14 16 Gauge Stainless Steel
TFEN-S16 0.09" Thick Aluminum

TECHNICAL SPECIFICATIONS

FENDER LENGTH	80"
WEIGHT PER SET	TFEN-S14: 67 lbs TFEN-S16: 39 lbs.
SOLD	As a Pair
WARRANTY	1 Year
DESIGNED TO FIT	43.5" O.D TIRES



TFEN-S14
16
 GAUGE

TFEN-S16
0.09"
 THICKNESS

SOLD AS A
PAIR

Trux recommends installing with Mounting Kits that are the SAME OR THICKER Gauge than the fender. **TFEN-SKIT, TFEN-SKITN or TFEN-SKITHD** (Page 172)

80" 4 RIBBED SINGLE AXLE FENDERS



BEADED EDGE
TFEN-S22 16 Gauge

TECHNICAL SPECIFICATIONS

FENDER LENGTH	80"
MATERIAL	Stainless Steel
WEIGHT PER SET	70 lbs.
SOLD	As a Pair
WARRANTY	1 Year
DESIGNED TO FIT	43.5" O.D TIRES



16
 GAUGE

SOLD AS A
PAIR

Trux recommends installing with Mounting Kits that are the SAME OR THICKER Gauge than the fender. **TFEN-SKIT, TFEN-SKITN or TFEN-SKITHD** (Page 172)

96" SMOOTH STRAIGHT DROP LOW RIDER - SINGLE AXLE FENDERS



ROLLED EDGE
TFEN-S37 14 Gauge

TECHNICAL SPECIFICATIONS

FENDER LENGTH	96"
MATERIAL	Stainless Steel
WEIGHT PER SET	110 lbs.
SOLD	As a Pair
WARRANTY	1 Year
DESIGNED TO FIT	43.5" O.D TIRES

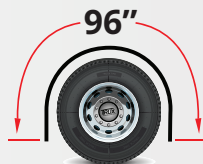

14
 GAUGE

SOLD AS A
PAIR

Trux recommends installing with Mounting Kits that are the SAME OR THICKER Gauge than the fender. **TFEN-SKITHD** (Page 172)

96" SMOOTH CURVED DROP ROLLIN' LO - SINGLE AXLE FENDERS



ROLLED EDGE
TFEN-S10 14 Gauge

TECHNICAL SPECIFICATIONS

FENDER LENGTH	96"
MATERIAL	Stainless Steel
WEIGHT PER SET	110 lbs.
SOLD	As a Pair
WARRANTY	1 Year
DESIGNED TO FIT	43.5" O.D TIRES



14
 GAUGE

SOLD AS A
PAIR

Trux recommends installing with Mounting Kits that are the SAME OR THICKER Gauge than the fender. **TFEN-SKITHD** (Page 172)

FENDERS

ADJUSTABLE FENDER BRACKET HALF FENDER MOUNTING KIT



▲
THREADED POST MOUNT

TFEN-HKIT 14 Gauge (Standard)

TFEN-HKITHD 12 Gauge (Heavy Duty)

NON THREADED POST MOUNT

TFEN-HKITN 14 Gauge (Standard)

TECHNICAL SPECIFICATIONS

KIT INCLUDES	2 x Adjustable Fender Brackets 2 x Triangle Mounts (14 or 12 Gauge) 2 x Post Mounts 2 x Clamps & All Hardware
MATERIAL	Stainless Steel
SOLD	As a Kit
WARRANTY	1 Year

OUTFITS
1 AXLE

SWIVEL FENDER BRACKET HALF FENDER MOUNTING KIT



▲
THREADED POST MOUNT

TFEN-HKIT2 14 Gauge (Standard)

TFEN-HKIT2HD 12 Gauge (Heavy Duty)

TECHNICAL SPECIFICATIONS

KIT INCLUDES	2 x 9" Swivel Fender Brackets 2 x Triangle Mounts (14 or 12 Gauge) 2 x Post Mounts 2 x Clamps & All Hardware
MATERIAL	Stainless Steel
SOLD	As a Kit
WARRANTY	1 Year

OUTFITS
1 AXLE

ADJUSTABLE FENDER BRACKET FULL FENDER MOUNTING KIT



▲
THREADED POST MOUNT

TFEN-FKIT 14 Gauge (Standard)

TFEN-FKITHD 12 Gauge (Heavy Duty)

NON THREADED POST MOUNT

TFEN-FKITN 14 Gauge (Standard)

TECHNICAL SPECIFICATIONS

KIT INCLUDES	2 x Adjustable Fender Brackets 4 x Triangle Mounts (14 or 12 Gauge) 4 x Post Mounts 4 x Clamps & All Hardware
MATERIAL	Stainless Steel
SOLD	As a Kit
WARRANTY	1 Year

OUTFITS
1 AXLE

SWIVEL FENDER BRACKET FULL FENDER MOUNTING KIT



▲
THREADED POST MOUNT

TFEN-FKIT2 14 Gauge (Standard)

TFEN-FKIT2HD 12 Gauge (Heavy Duty)

TECHNICAL SPECIFICATIONS

KIT INCLUDES	2 x 9" Swivel Fender Brackets 4 x Triangle Mounts (14 or 12 Gauge) 4 x Post Mounts 4 x Clamps & All Hardware
MATERIAL	Stainless Steel
SOLD	As a Kit
WARRANTY	1 Year

OUTFITS
1 AXLE

▲ WARNING: Cancer and Reproductive Harm - www.p65warnings.ca.gov

TRIANGLE MOUNT

SINGLE AXLE FENDER MOUNTING KIT



THREADED POST MOUNT

TFEN-SKIT 14 Gauge (Standard)

TFEN-SKITHD 12 Gauge (Heavy Duty)

NON THREADED POST MOUNT

TFEN-SKITN 14 Gauge (Standard)

TECHNICAL SPECIFICATIONS

KIT INCLUDES	4 x Triangle Mounts (14 or 12 Gauge)
	4 x Post Mounts
	4 x Clamps & All Hardware
MATERIAL	Stainless Steel
SOLD	As a Kit
WARRANTY	1 Year

OUTFITS
1 AXLE



The swivel mounting bracket is designed for easy installation and avoids any tension that can be encountered when installing. The fender will stay in a neutral state, whereas the bracket can rotate to meet the fender, avoiding any dimples that can lead to a cracked fender!

Swivel Bracket
Rotates to meet the fender



WARNING: Cancer and Reproductive Harm - www.p65warnings.ca.gov

FENDERS

SWIVEL FENDER BRACKETS



▲ 9" OFFSET
TFEN-A54



▲ 4" OFFSET
TFEN-A58

TECHNICAL SPECIFICATIONS

KIT INCLUDES	1 x Black Rubber Inset 1 x Top Plate 1 x Back Plate All Hardware
DIMENSIONS	33" x 8" x 4"
DESIGNED TO FIT	Half & Full Fenders
MATERIAL	Steel
SOLD	Individually

ADJUSTABLE FENDER BRACKETS



▲ DRIVER SIDE
TFEN-A29



▲ PASSENGER SIDE
TFEN-A30

TECHNICAL SPECIFICATIONS

DESIGNED TO FIT	6" - 8.5" Suspension Height Fits 90% of ALL Truck Suspensions
MATERIAL	Steel
SOLD	Individually
APPLICATION	TFEN-A29: Driver Side TFEN-A30: Passenger Side

TRIANGLE MOUNT WELDED END CAP



▲ STANDARD 14 GAUGE
TFEN-A10 Mount Only
TFEN-A11 Mount With Bolt Kit
TFEN-A12 Mount With Bolt Kit & Hardware



▲ HEAVY DUTY 12 GAUGE
TFEN-A13 Heavy Duty Mount

TECHNICAL SPECIFICATIONS

	DIMENSIONS	PART NUMBER	TFEN-A10	TFEN-A11	TFEN-A12	TFEN-A13
DIMENSIONS	31" Long					
DESIGNED TO FIT	24" & 26" Wide Fenders					
MATERIAL	Stainless Steel					
SOLD	Individually					
WHAT'S INCLUDED			1 x 14 Ga. Triangle Mount with End Cap	1 x 14 Ga. Triangle Mount with End Cap 1 x Bolt Kit	1 x 14 Ga. Triangle Mount with End Cap 1 x Bolt Kit & Straps	1 x 12 Ga. Triangle Mount with Welded End Cap

▲ WARNING: Cancer and Reproductive Harm - www.p65warnings.ca.gov

TRIANGLE MOUNT ACCESSORIES

BOLT KIT | METAL PLATE KIT



METAL PLATE
TFEN-A38

TECHNICAL SPECIFICATIONS

KIT INCLUDES	1 x Metal Plate
DESIGNED TO FIT	TFEN-A10, TFEN-A11, TFEN-A12 & TFEN-A13
MATERIAL	Metal
SOLD	Individually



BOLT KIT
TFEN-A36

TECHNICAL SPECIFICATIONS

KIT INCLUDES	6 x Bolts 6 x Washers
DESIGNED TO FIT	TFEN-A10, TFEN-A11, TFEN-A12 & TFEN-A13
MATERIAL	Metal
SOLD	As a Kit

POST MOUNT ACCESSORIES



POST MOUNT
TFEN-A15 Threaded
TFEN-A17 Non Threaded

TECHNICAL SPECIFICATIONS

DESIGNED TO FIT	TFEN-A15: TFEN-A44
MATERIAL	Steel
SOLD	Individually



3/4" FINE THREAD BOLT
TFEN-A44

TECHNICAL SPECIFICATIONS

DESIGNED TO FIT	TFEN-A15
MATERIAL	Stainless Steel
SOLD	Individually

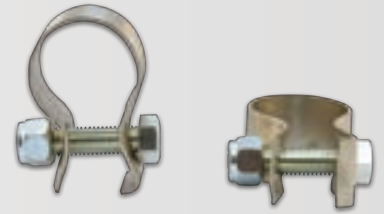

POST MOUNT CLAMP
TFEN-A19

TECHNICAL SPECIFICATIONS

KIT INCLUDES	1 x Bolt 1 x Clamp
MATERIAL	Stainless Steel
SOLD	Individually

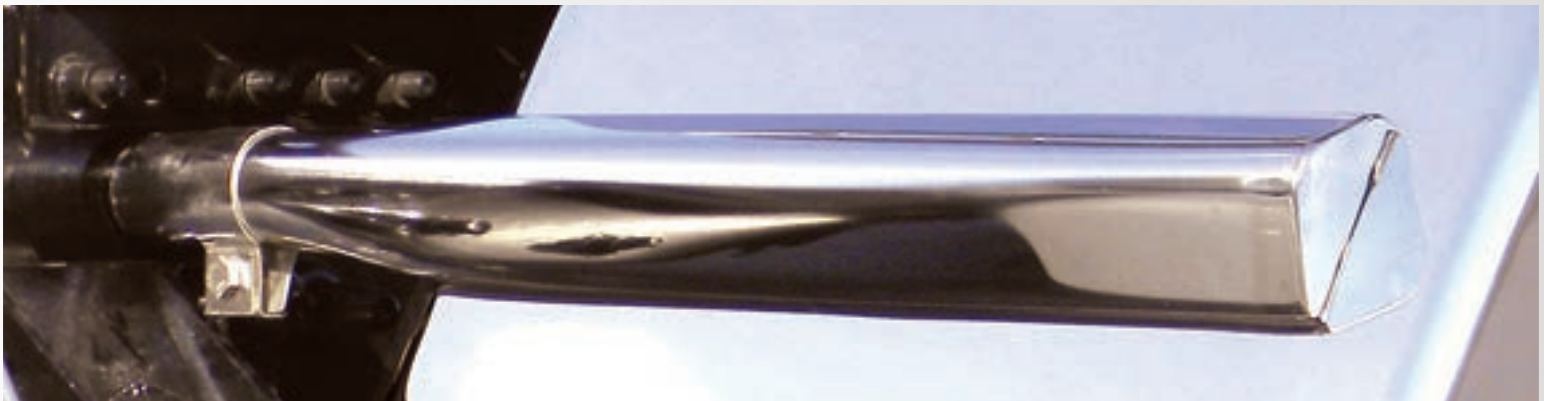

WARNING: Cancer and Reproductive Harm - www.p65warnings.ca.gov

FENDERS

24" TUBE MOUNT POLY QUARTER FENDER KIT

**TOP
SELLER**



ROLLED EDGE
TFEN-Q20

TECHNICAL SPECIFICATIONS

FENDER LENGTH	24"
MATERIAL	PP / EDPM
WEIGHT PER SET	20 lbs.
SOLD	As a Kit
WARRANTY	1 Year

KIT INCLUDES

2 x Fenders
2 x Tube Mounts
2 x Clamps
2 x Top Mud Flaps
& Hardware

TUBE MOUNT



SOLD AS A
KIT



66" HALF TANDEM POLY FENDERS

**TOP
SELLER**



ROLLED EDGE
TFEN-H39

TECHNICAL SPECIFICATIONS

FENDER LENGTH	66"
MATERIAL	PP / EDPM
WEIGHT PER SET	24.5 lbs.
SOLD	As a Pair
WARRANTY	1 Year

DESIGNED TO FIT **43.5"/46.5" O.D TIRES**

For Half Tandem Poly Fenders, Trux recommends installing with Mounting Kits: **TFEN-HKITP**, **TFEN-HKITP2** or **TFEN-HKITP3** (Page 177)

SOLD AS A
PAIR

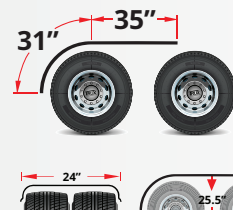

WARNING: Cancer and Reproductive Harm - www.p65warnings.ca.gov



ROLLED EDGE
TFEN-S17

TECHNICAL SPECIFICATIONS

FENDER LENGTH	76"
MATERIAL	PP / EDPM
WEIGHT PER SET	19.5 lbs.
SOLD	As a Pair
WARRANTY	1 Year

DESIGNED TO FIT **46.5" O.D TIRES**

For Single Axle Poly Fenders, Trux recommends installing with Mounting Kits: **TFEN-SKITP** or **TFEN-SKITP2** (Page 177-178)

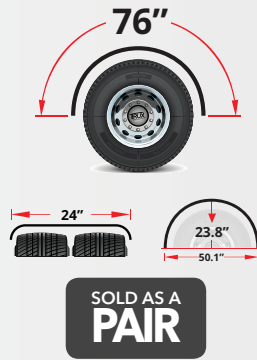

ROLLED EDGE
TFEN-F26

TECHNICAL SPECIFICATIONS

FENDER LENGTH	133"
MATERIAL	PP / EDPM
WEIGHT PER SET	29 lbs.
SOLD	As a Pair
WARRANTY	1 Year

DESIGNED TO FIT **43.5" O.D TIRES**

For Full Tandem Poly Fenders, Trux recommends installing with Mounting Kits: **TFEN-FKITP**, **TFEN-FKITP2** or **TFEN-FKITP3** (Page 178)

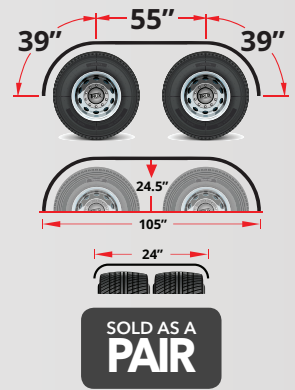

ROLLED EDGE
TFEN-H66

TECHNICAL SPECIFICATIONS

FENDER LENGTH	105"
MATERIAL	PP / EDPM
WEIGHT PER SET	29 lbs.
SOLD	As a Pair
WARRANTY	1 Year

DESIGNED TO FIT **Universal**

For Half Tandem Poly Fenders, Trux recommends installing with Mounting Kits: **TFEN-HKITP**, **TFEN-HKITP2** or **TFEN-HKITP3** (Page 177)

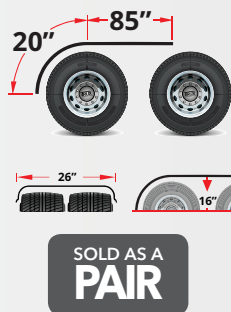

ROLLED EDGE
TFEN-F40

TECHNICAL SPECIFICATIONS

FENDER LENGTH	105"
MATERIAL	PP / EDPM
WEIGHT PER SET	36 lbs.
SOLD	As a Pair
WARRANTY	1 Year

DESIGNED TO FIT **43.5" O.D TIRES**

For Full Tandem Poly Fenders, Trux recommends installing with Mounting Kits: **TFEN-FKITP**, **TFEN-FKITP2** or **TFEN-FKITP3** (Page 178)

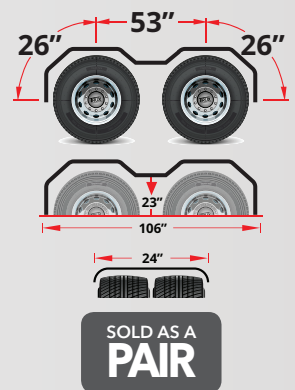

FENDERS

ADJUSTABLE FENDER BRACKET HALF FENDER MOUNTING KIT



ADJUSTABLE FENDER BRACKET KIT
TFEN-HKITP

TECHNICAL SPECIFICATIONS

KIT INCLUDES	2 x Adjustable Fender Brackets 2 x Black Triangle Mounts 2 x Black Threaded Post Mounts 2 x Black Clamps & All Hardware
MATERIAL	Painted Steel
SOLD	As a Kit
WARRANTY	1 Year

OUTFITS
1 AXLE

SWIVEL FENDER BRACKET HALF FENDER MOUNTING KIT



SWIVEL FENDER BRACKET KIT
TFEN-HKITP2

TECHNICAL SPECIFICATIONS

KIT INCLUDES	2 x 9" Swivel Fender Brackets 2 x Black Tube Mounts 2 x Black Threaded Post Mounts 2 x Black Clamps & All Hardware
MATERIAL	Painted Steel
SOLD	As a Kit
WARRANTY	1 Year

OUTFITS
1 AXLE

ANGLED FENDER BRACKET HALF FENDER MOUNTING KIT



ANGLED FENDER BRACKET KIT
TFEN-HKITP3

TECHNICAL SPECIFICATIONS

KIT INCLUDES	2 x Black Mounting Brackets 2 x Black Tube Mounts 2 x Black Threaded Post Mounts 2 x Black Clamps & All Hardware
MATERIAL	Painted Steel
SOLD	As a Kit
WARRANTY	1 Year

OUTFITS
1 AXLE

TRIANGLE MOUNTS SINGLE AXLE FENDER MOUNTING KIT



TRIANGLE MOUNT KIT
TFEN-SKITP

TECHNICAL SPECIFICATIONS

KIT INCLUDES	4 x Black Triangle Mounts 4 x Black Threaded Post Mounts 4 x Black Clamps & All Hardware
MATERIAL	Painted Steel
SOLD	As a Kit
WARRANTY	1 Year

OUTFITS
1 AXLE

TUBE MOUNTS

SINGLE AXLE FENDER MOUNTING KIT

**TOP
SELLER**



TUBE MOUNT KIT
TFEN-SKITP2

TECHNICAL SPECIFICATIONS

KIT INCLUDES	4 x Black Tube Mounts 4 x Black Threaded Post Mounts 4 x Black Clamps & All Hardware
MATERIAL	Painted Steel
SOLD	As a Kit
WARRANTY	1 Year

OUTFITS
1 AXLE

ADJUSTABLE FENDER BRACKET

FULL FENDER MOUNTING KIT



ADJUSTABLE FENDER BRACKET KIT
TFEN-FKITP

TECHNICAL SPECIFICATIONS

KIT INCLUDES	2 x Adjustable Fender Brackets 4 x Black Triangle Mounts 4 x Black Threaded Post Mounts 4 x Black Clamps & All Hardware
MATERIAL	Painted Steel
SOLD	As a Kit
WARRANTY	1 Year

OUTFITS
1 AXLE

SWIVEL FENDER BRACKET

FULL FENDER MOUNTING KIT

**TOP
SELLER**



SWIVEL FENDER BRACKET KIT
TFEN-FKITP2

TECHNICAL SPECIFICATIONS

KIT INCLUDES	2 x 9" Swivel Fender Brackets 4 x Black Tube Mounts 4 x Black Threaded Post Mounts 4 x Black Clamps & All Hardware
MATERIAL	Painted Steel
SOLD	As a Kit
WARRANTY	1 Year

OUTFITS
1 AXLE

ANGLED FENDER BRACKET

FULL FENDER MOUNTING KIT



ANGLED FENDER BRACKET KIT
TFEN-FKITP3

TECHNICAL SPECIFICATIONS

KIT INCLUDES	2 x Black Mounting Brackets 4 x Black Tube Mounts 4 x Black Threaded Post Mounts 4 x Black Clamps & All Hardware
MATERIAL	Painted Steel
SOLD	As a Kit
WARRANTY	1 Year

OUTFITS
1 AXLE

FENDERS

SWIVEL FENDER BRACKETS



▲ 9" OFFSET
TFEN-A54



▲ 4" OFFSET
TFEN-A58

TECHNICAL SPECIFICATIONS

KIT INCLUDES	1 x Black Rubber Inset 1 x Top Plate 1 x Back Plate All Hardware
DIMENSIONS	33" x 8" x 4"
DESIGNED TO FIT	Half & Full Fenders
MATERIAL	Steel
SOLD	Individually

ADJUSTABLE FENDER BRACKETS



▲ DRIVER SIDE
TFEN-A29



▲ PASSENGER SIDE
TFEN-A30

TECHNICAL SPECIFICATIONS

DESIGNED TO FIT	6" - 8.5" Suspension Height Fits 90% of ALL Truck Suspensions
MATERIAL	Steel
SOLD	Individually
APPLICATION	TFEN-A29: Driver Side TFEN-A30: Passenger Side

ANGLED FENDER BRACKETS



▲ DRIVER SIDE
TFEN-A63



▲ PASSENGER SIDE
TFEN-A64

TECHNICAL SPECIFICATIONS

DESIGNED TO FIT	6" - 8.5" Suspension Height
MATERIAL	Steel
SOLD	Individually
WARRANTY	1 Year

▲ WARNING: Cancer and Reproductive Harm - www.p65warnings.ca.gov

TUBE MOUNT STAINLESS STEEL



▲
TUBE MOUNT WITH CLAMP & POST MOUNT SET
TFEN-A55

TECHNICAL SPECIFICATIONS

KIT INCLUDES	1 x Black Tube Mount 1 x Post Mount 1 x Black Clamp All Hardware
MATERIAL	Black Stainless Steel
SOLD	Kit
WARRANTY	1 Year

TRIANGLE MOUNT WITH BOLT KIT



▲
TRIANGLE MOUNT WITH BOLT KIT
TFEN-A53

TECHNICAL SPECIFICATIONS

KIT INCLUDES	1 x Black Triangle Mount with Welded End Cap 6 x Bolts 6 x Washer
ARM GAUGE	14 Gauge
DIMENSIONS	29" Long
MATERIAL	Black Stainless Steel
SOLD	Individually
WARRANTY	1 Year

JOIN TRUX'S POLY FENDER PROGRAM AND RECIEVE A FREE DISPLAY!

CONTACT YOUR TRUX ACCOUNT MANAGER TODAY!



STARTER
TRX-173

'STARTER' FENDER DISPLAY
RETAIL SPACE: 36" X 24" X 47"



STANDARD
TRX-172

'STANDARD' FENDER DISPLAY
RETAIL SPACE: 36" X 48" X 51"



PREMIUM
TRX-112

'PREMIUM' FENDER DISPLAY
RETAIL SPACE: 43" x 48" x 92"

EXHAUST

COMPLETE 8" / 7" / 6" DIAMETER KITS

52" MIDDLE SPOOLS - 90° ELBOWS - PRE-2007 PETERBILT MODELS

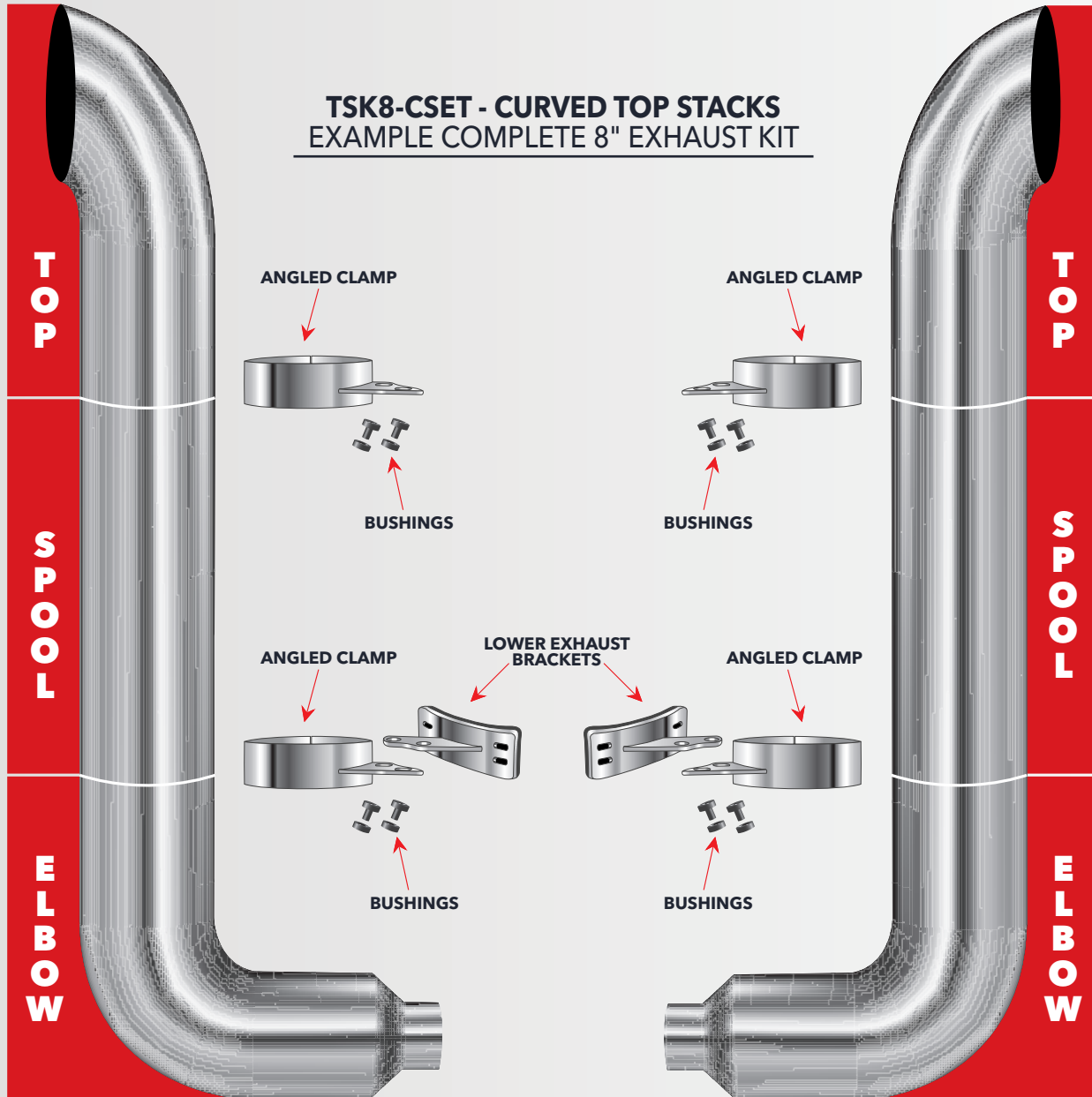

TECHNICAL SPECIFICATIONS

MATERIAL	Chrome Plated Stainless Steel
SOLD	As a Kit
WARRANTY	1 Year

ALL 8" / 7" / 6" KITS INCLUDE

- 2 x Top Stacks (54" or 60" High)
- 2 x Middle Spools (52" High)
- 2 x 90° Elbows (Reduced to 5" O.D)
- 4 x 3.75" Angled Wide Band & Clamps
- 2 x Angled Lower Exhaust Brackets
- 8 x Black Bushings

90° ELBOWS REDUCED TO 5"

All 8"/7"/6" Elbows are Reduced to 5" Diameter in order to be used with the 5" Y-Pipe.

Clamps are Chrome Plated Stainless Steel, allowing the clamps to have the same mirror shine finish as the exhaust components.

 WARNING: Cancer and Reproductive Harm - www.p65warnings.ca.gov

54" / 60" TOP STACK KITS - 52" MIDDLE SPOOLS
 90° ELBOWS REDUCED TO 5" - PRE-2007 PETERBILT MODELS



8" DIAMETER KITS	TSK8-MSET 54" Mitered Top Stacks	TSK8-CSET 54" Curved Top Stacks	TSK8-BSET 54" Bullhorn Top Stacks	TSK8-FSET 54" Flat Top Stacks
	TSK8-MSET2 60" Mitered Top Stacks	TSK8-CSET2 60" Curved Top Stacks	TSK8-BSET2 60" Bullhorn Top Stacks	TSK8-FSET2 60" Flat Top Stacks
7" DIAMETER KITS	TSK7-MSET 54" Mitered Top Stacks	TSK7-CSET 54" Curved Top Stacks	TSK7-BSET 54" Bullhorn Top Stacks	Part Not Available
	TSK7-MSET2 60" Mitered Top Stacks	TSK7-CSET2 60" Curved Top Stacks	TSK7-BSET2 60" Bullhorn Top Stacks	Part Not Available
6" DIAMETER KITS	TSK6-MSET 54" Mitered Top Stacks	TSK6-CSET 54" Curved Top Stacks	TSK6-BSET 54" Bullhorn Top Stacks	Part Not Available
	TSK6-MSET2 60" Mitered Top Stacks	TSK6-CSET2 60" Curved Top Stacks	TSK6-BSET2 60" Bullhorn Top Stacks	Part Not Available



WARNING: Cancer and Reproductive Harm - www.p65warnings.ca.gov

EXHAUST

COMPLETE 8" / 7" / 6" DIAMETER KITS

55" MIDDLE SPOOLS - 90° ELBOWS - PRE-2007 PETERBILT MODELS

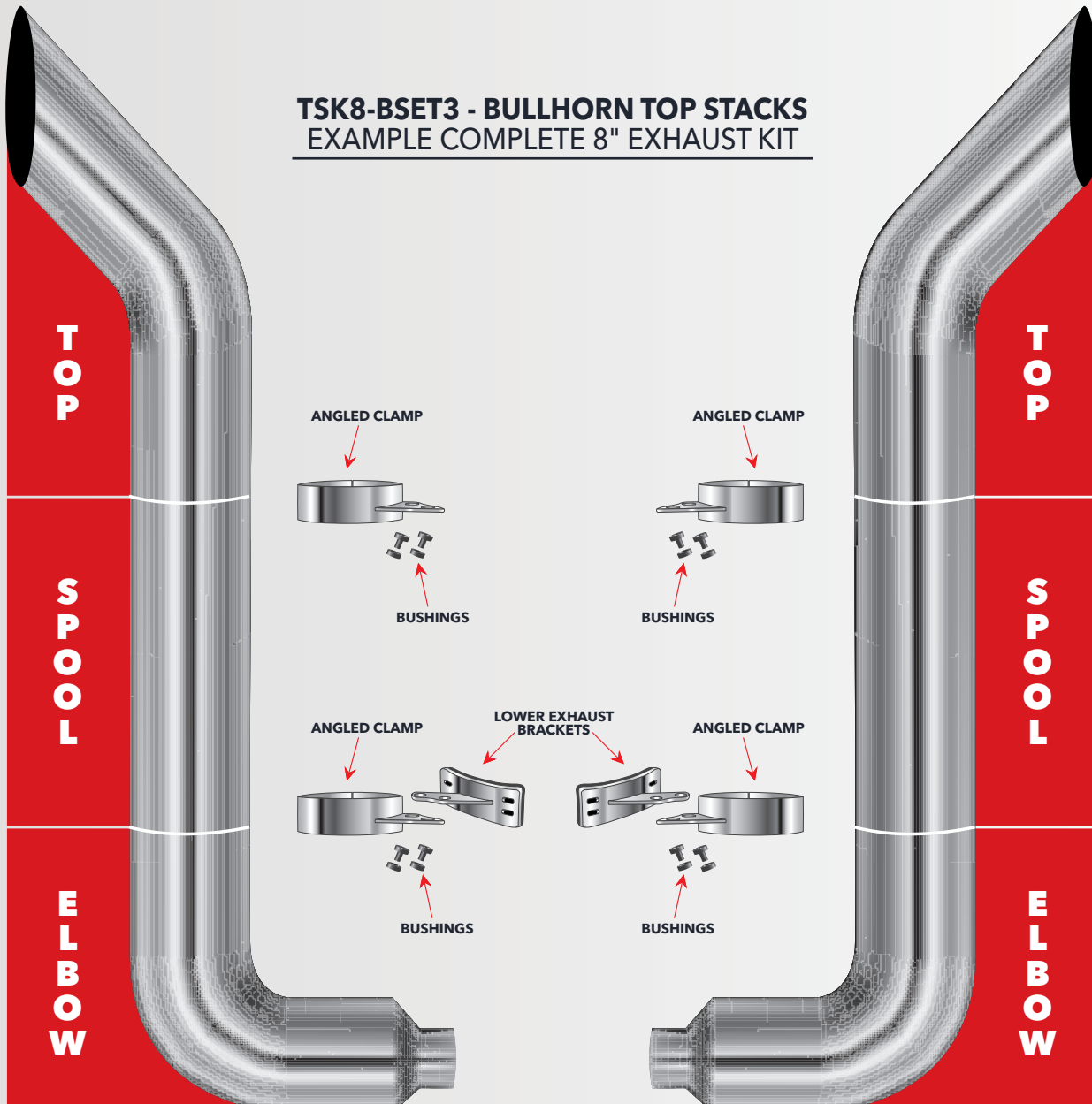

TSK8-BSET3 - BULLHORN TOP STACKS
EXAMPLE COMPLETE 8" EXHAUST KIT

TECHNICAL SPECIFICATIONS

MATERIAL	Chrome Plated Stainless Steel
SOLD	As a Kit
WARRANTY	1 Year

ALL 8" / 7" / 6" KITS INCLUDE

- 2 x Top Stacks (54" or 60" High)
- 2 x Middle Spools (55" High)
- 2 x 90° Elbows (Reduced to 5" O.D)
- 4 x 3.75" Angled Wide Band & Clamps
- 2 x Angled Lower Exhaust Brackets
- 8 x Black Bushings

90° ELBOWS REDUCED TO 5"

All 8"/7"/6" Elbows are Reduced to 5" Diameter in order to be used with the 5" Y-Pipe.

Clamps are Chrome Plated Stainless Steel, allowing the clamps to have the same mirror shine finish as the exhaust components.

 **WARNING: Cancer and Reproductive Harm - www.p65warnings.ca.gov**

54" / 60" TOP STACK KITS - 55" MIDDLE SPOOLS
 90° ELBOWS REDUCED TO 5" - PRE-2007 PETERBILT MODELS

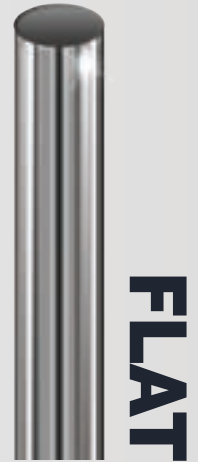

8" DIAMETER KITS	TSK8-MSET5 54" Mitered Top Stacks	TSK8-CSET4 54" Curved Top Stacks	TSK8-BSET3 54" Bullhorn Top Stacks	TSK8-FSET4 54" Flat Top Stacks
	TSK8-MSET3 60" Mitered Top Stacks	TSK8-CSET3 60" Curved Top Stacks	TSK8-BSET4 60" Bullhorn Top Stacks	TSK8-FSET5 60" Flat Top Stacks

7" DIAMETER KITS	TSK7-MSET6 54" Mitered Top Stacks	TSK7-CSET6 54" Curved Top Stacks	TSK7-BSET5 54" Bullhorn Top Stacks	Part Not Available
	TSK7-MSET5 60" Mitered Top Stacks	TSK7-CSET5 60" Curved Top Stacks	TSK7-BSET6 60" Bullhorn Top Stacks	Part Not Available

6" DIAMETER KITS	TSK6-MSET5 54" Mitered Top Stacks	TSK6-CSET5 54" Curved Top Stacks	TSK6-BSET5 54" Bullhorn Top Stacks	Part Not Available
	TSK6-MSET6 60" Mitered Top Stacks	TSK6-CSET6 60" Curved Top Stacks	TSK6-BSET6 60" Bullhorn Top Stacks	Part Not Available



WARNING: Cancer and Reproductive Harm - www.p65warnings.ca.gov

EXHAUST

COMPLETE 10" DIAMETER KITS

52" / 55" MIDDLE SPOOLS - 90° ELBOWS - PRE-2007 PETERBILT MODELS

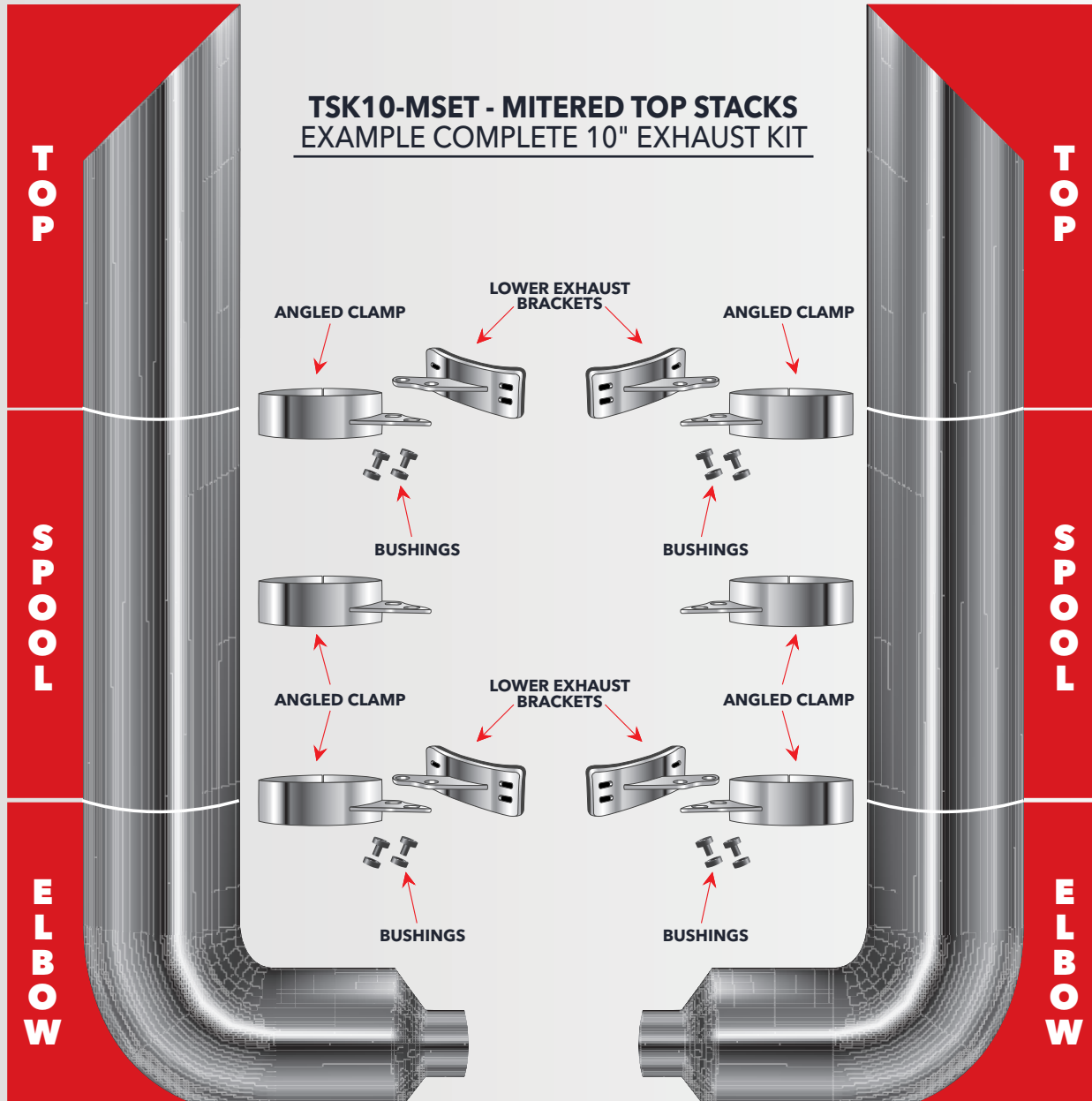

TECHNICAL SPECIFICATIONS

MATERIAL	Chrome Plated Stainless Steel
SOLD	As a Kit
WARRANTY	1 Year

ALL 10" KITS INCLUDE

- 2 x Top Stacks (54" or 60" High)
- 2 x Middle Spools (52" or 55" High)
- 2 x 90° Elbows (Reduced to 5" O.D)
- 6 x 3.75" Angled Wide Band & Clamps
- 4 x Angled Lower Exhaust Brackets
- 8 x Black Bushings

90° ELBOWS REDUCED TO 5"

All 10" Elbows are Reduced to 5" Diameter in order to be used with the 5" Y-Pipe.

Clamps are Chrome Plated Stainless Steel, allowing the clamps to have the same mirror shine finish as the exhaust components.

WARNING: Cancer and Reproductive Harm - www.p65warnings.ca.gov

54" / 60" TOP STACK KITS - 52" MIDDLE SPOOLS
 90° ELBOWS REDUCED TO 5" - PRE-2007 PETERBILT MODELS



10" DIAMETER KITS	TSK10-MSET 54" Mitered Top Stacks	TSK10-CSET 54" Curved Top Stacks	TSK10-BSET 54" Bullhorn Top Stacks	TSK10-FSET 54" Flat Top Stacks
	TSK10-MSET2 60" Mitered Top Stacks	TSK10-CSET2 60" Curved Top Stacks	TSK10-BSET2 60" Bullhorn Top Stacks	TSK10-FSET2 60" Flat Top Stacks

54" / 60" TOP STACK KITS - 55" MIDDLE SPOOLS
 90° ELBOWS REDUCED TO 5"



10" DIAMETER KITS	TSK10-MSET3 54" Mitered Top Stacks	TSK10-CSET3 54" Curved Top Stacks	TSK10-BSET3 54" Bullhorn Top Stacks	TSK10-FSET3 54" Flat Top Stacks
	TSK10-MSET4 60" Mitered Top Stacks	TSK10-CSET4 60" Curved Top Stacks	TSK10-BSET4 60" Bullhorn Top Stacks	TSK10-FSET4 60" Flat Top Stacks

EXHAUST

COMPLETE 8" / 7" / 6" DIAMETER KITS

52" MIDDLE SPOOLS - 58° ELBOWS - PRE-2007 PETERBILT MODELS

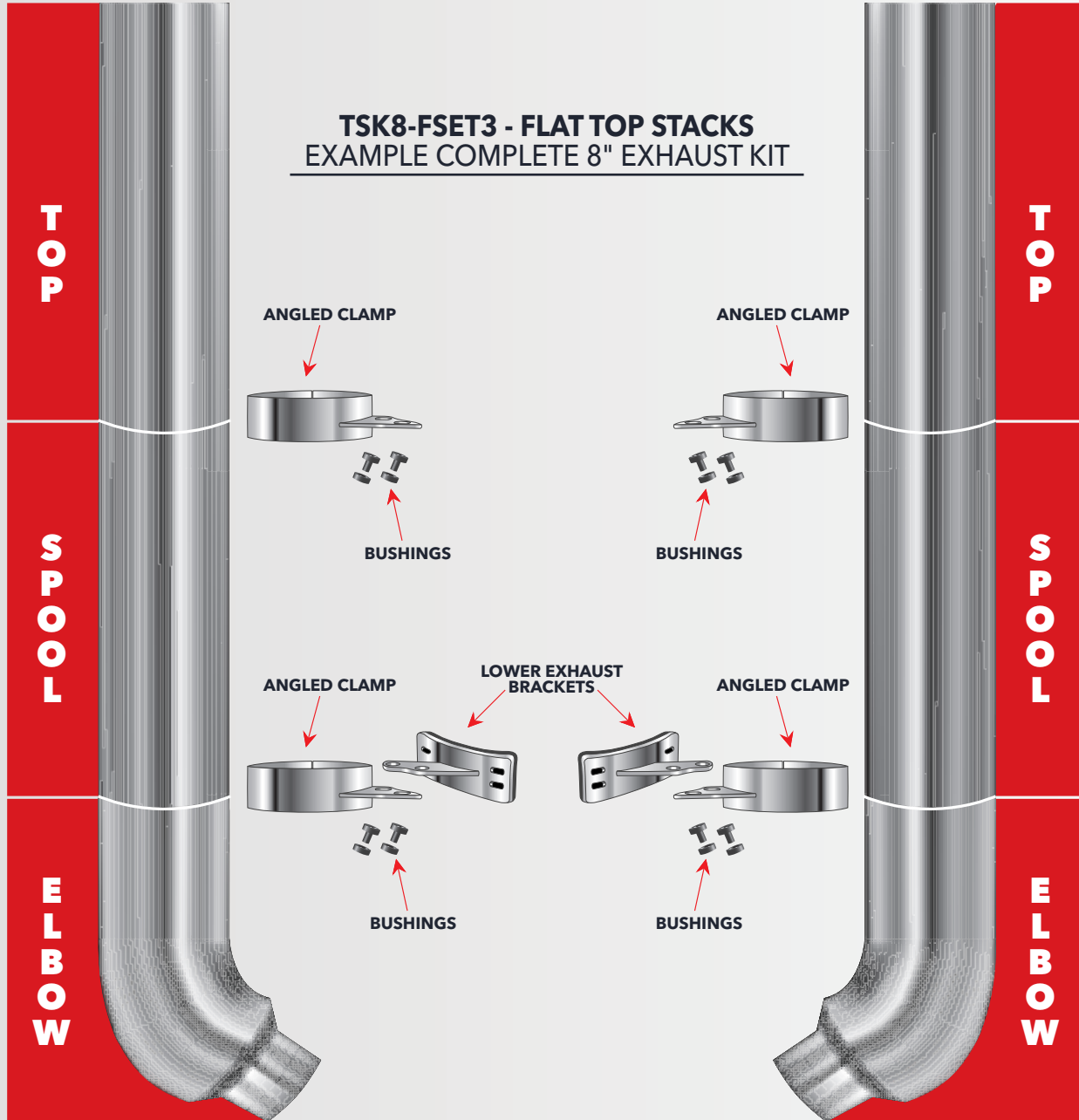

TSK8-FSET3 - FLAT TOP STACKS
EXAMPLE COMPLETE 8" EXHAUST KIT

TECHNICAL SPECIFICATIONS

MATERIAL	Chrome Plated Stainless Steel
SOLD	As a Kit
WARRANTY	1 Year

ALL 8" / 7" / 6" KITS INCLUDE

- 2 x Top Stacks (54" or 60" High)
- 2 x Middle Spools (52" High)
- 2 x 58° Elbows (Reduced to 5" O.D.)
- 4 x 3.75" Angled Wide Band & Clamps
- 2 x Angled Lower Exhaust Brackets
- 8 x Black Bushings

90° ELBOWS REDUCED TO 5"

All 8"/7"/6" Elbows are Reduced to 5" Diameter in order to be used with the 5" Y-Pipe.

Clamps are Chrome Plated Stainless Steel, allowing the clamps to have the same mirror shine finish as the exhaust components.

WARNING: Cancer and Reproductive Harm - www.p65warnings.ca.gov

54" / 60" TOP STACK KITS - 52" MIDDLE SPOOLS
 58° ELBOWS REDUCED TO 5" - PRE-2007 PETERBILT MODELS



8" DIAMETER KITS	TSK8-MSET4 54" Mitered Top Stacks	TSK8-CSET5 54" Curved Top Stacks	TSK8-BSET5 54" Bullhorn Top Stacks	TSK8-FSET3 54" Flat Top Stacks
	TSK8-MSET6 60" Mitered Top Stacks	TSK8-CSET6 60" Curved Top Stacks	TSK8-BSET6 60" Bullhorn Top Stacks	TSK8-FSET6 60" Flat Top Stacks

7" DIAMETER KITS	TSK7-MSET3 54" Mitered Top Stacks	TSK7-CSET3 54" Curved Top Stacks	TSK7-BSET3 54" Bullhorn Top Stacks	Part Not Available
	TSK7-MSET4 60" Mitered Top Stacks	TSK7-CSET4 60" Curved Top Stacks	TSK7-BSET4 60" Bullhorn Top Stacks	Part Not Available

6" DIAMETER KITS	TSK6-MSET3 54" Mitered Top Stacks	TSK6-CSET3 54" Curved Top Stacks	TSK6-BSET3 54" Bullhorn Top Stacks	Part Not Available
	TSK6-MSET4 60" Mitered Top Stacks	TSK6-CSET4 60" Curved Top Stacks	TSK6-BSET4 60" Bullhorn Top Stacks	Part Not Available



WARNING: Cancer and Reproductive Harm - www.p65warnings.ca.gov

EXHAUST

COMPLETE 8" / 7" / 6" DIAMETER KITS

55" MIDDLE SPOOLS - 58° ELBOWS - PRE-2007 PETERBILT MODELS

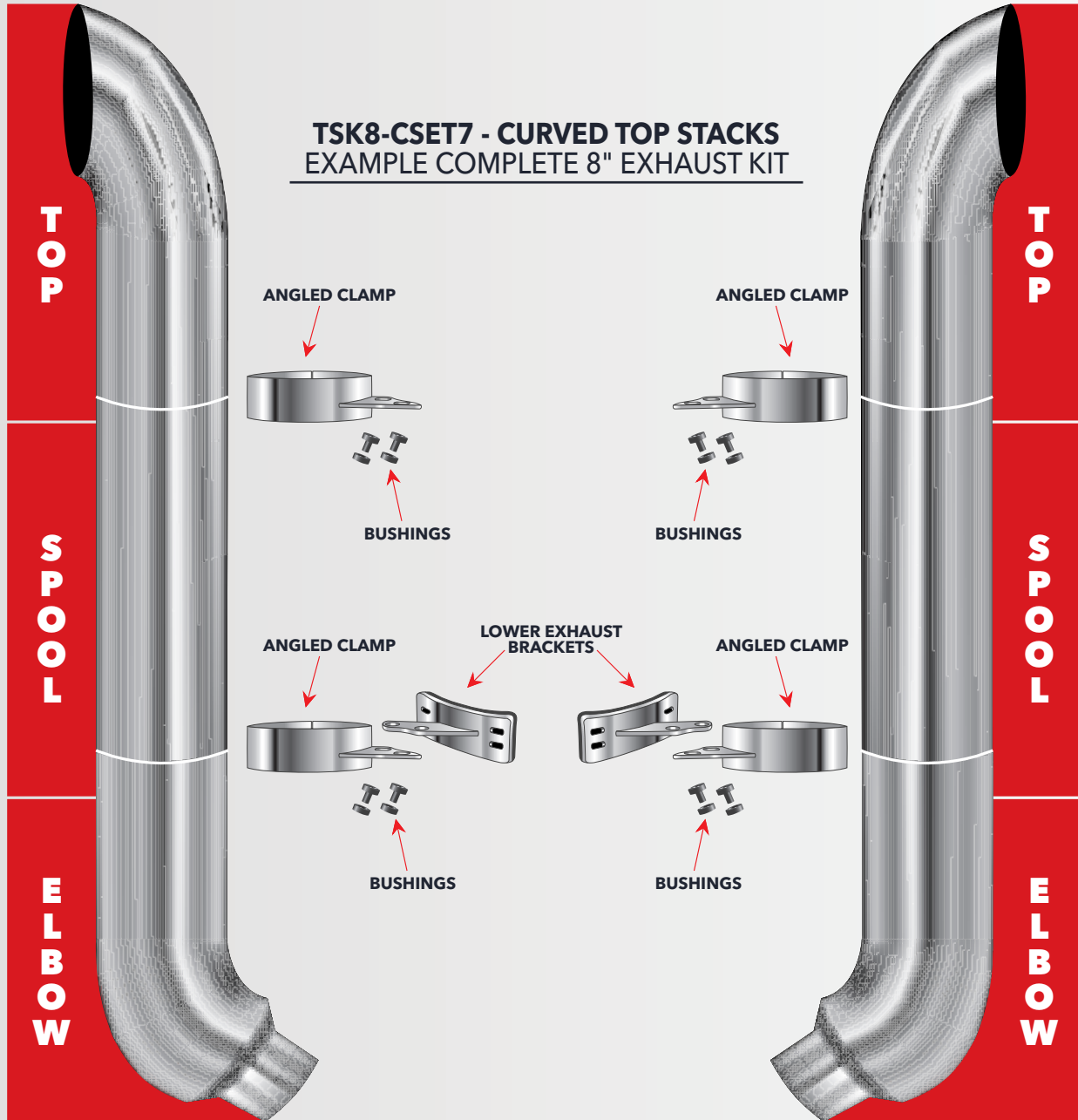

TSK8-CSET7 - CURVED TOP STACKS
EXAMPLE COMPLETE 8" EXHAUST KIT

TECHNICAL SPECIFICATIONS

MATERIAL	Chrome Plated Stainless Steel
SOLD	As a Kit
WARRANTY	1 Year

ALL 8" / 7" / 6" KITS INCLUDE

- 2 x Top Stacks (54" or 60" High)
- 2 x Middle Spools (55" High)
- 2 x 58° Elbows (Reduced to 5" O.D)
- 4 x 3.75" Angled Wide Band & Clamps
- 2 x Angled Lower Exhaust Brackets
- 8 x Black Bushings

90° ELBOWS REDUCED TO 5"

All 8"/7"/6" Elbows are Reduced to 5" Diameter in order to be used with the 5" Y-Pipe.

Clamps are Chrome Plated Stainless Steel, allowing the clamps to have the same mirror shine finish as the exhaust components.

WARNING: Cancer and Reproductive Harm - www.p65warnings.ca.gov

54" / 60" TOP STACK KITS - 55" MIDDLE SPOOLS
 58° ELBOWS REDUCED TO 5" - PRE-2007 PETERBILT MODELS

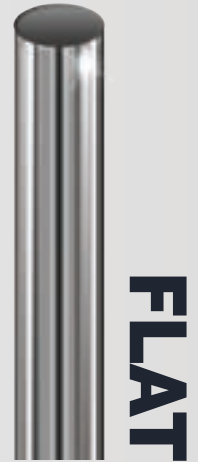

8" DIAMETER KITS	TSK8-MSET7 54" Mitered Top Stacks	TSK8-CSET7 54" Curved Top Stacks	TSK8-BSET7 54" Bullhorn Top Stacks	TSK8-FSET7 54" Flat Top Stacks
	TSK8-MSET8 60" Mitered Top Stacks	TSK8-CSET8 60" Curved Top Stacks	TSK8-BSET8 60" Bullhorn Top Stacks	TSK8-FSET8 60" Flat Top Stacks

7" DIAMETER KITS	TSK7-MSET7 54" Mitered Top Stacks	TSK7-CSET7 54" Curved Top Stacks	TSK7-BSET7 54" Bullhorn Top Stacks	Part Not Available
	TSK7-MSET8 60" Mitered Top Stacks	TSK7-CSET8 60" Curved Top Stacks	TSK7-BSET8 60" Bullhorn Top Stacks	Part Not Available

6" DIAMETER KITS	TSK6-MSET7 54" Mitered Top Stacks	TSK6-CSET7 54" Curved Top Stacks	TSK6-BSET7 54" Bullhorn Top Stacks	Part Not Available
	TSK6-MSET8 60" Mitered Top Stacks	TSK6-CSET8 60" Curved Top Stacks	TSK6-BSET8 60" Bullhorn Top Stacks	Part Not Available



WARNING: Cancer and Reproductive Harm - www.p65warnings.ca.gov

EXHAUST

54" / 60" TOP STACKS PRE-2007 TRUCK MODELS - SOLD INDIVIDUALLY



10"
DIAMETER
TOP STACK

TSK10-M54T
54" Mitered Top Stack

TSK10-C54T
54" Curved Top Stack

TSK10-B54T
54" Bullhorn Top Stack

TSK10-F54T
54" Flat Top Stack

TSK10-M60T
60" Mitered Top Stack

TSK10-C60T
60" Curved Top Stack

TSK10-B60T
60" Bullhorn Top Stack

TSK10-F60T
60" Flat Top Stack

8"
DIAMETER
TOP STACK

TSK8-M54T
54" Mitered Top Stack

TSK8-C54T
54" Curved Top Stack

TSK8-B54T
54" Bullhorn Top Stack

TSK8-F54T
54" Flat Top Stack

TSK8-M60T
60" Mitered Top Stack

TSK8-C60T
60" Curved Top Stack

TSK8-B60T
60" Bullhorn Top Stack

TSK8-F60T
60" Flat Top Stack

7"
DIAMETER
TOP STACK

TSK7-M54T
54" Mitered Top Stack

TSK7-C54T
54" Curved Top Stack

TSK7-B54T
54" Bullhorn Top Stack

Part Not Available

TSK7-M60T
60" Mitered Top Stack

TSK7-C60T
60" Curved Top Stack

TSK7-B60T
60" Bullhorn Top Stack

Part Not Available

6"
DIAMETER
TOP STACK

TSK6-M54T
54" Mitered Top Stack

TSK6-C54T
54" Curved Top Stack

TSK6-B54T
54" Bullhorn Top Stack

Part Not Available

TSK6-M60T
60" Mitered Top Stack

TSK6-C60T
60" Curved Top Stack

TSK6-B60T
60" Bullhorn Top Stack

Part Not Available



TRUX'S RETAIL PACKAGING

INFORMATIVE, EYE-CATCHING RETAIL BOX

PROTECTING YOUR PURCHASE DURING TRANSIT

ALL OF TRUX'S EXHAUSTS KITS, TOP STACKS, SPOOLS
& ACCESSORIES ARE SHIPPED IN HIGH QUALITY
PACKAGING FOR YOUR CONVENIENCE

WARNING: Cancer and Reproductive Harm - www.p65warnings.ca.gov

52" / 55" MIDDLE SPOOLS
 PLAIN BOTTOM | REDUCED TO 5" BOTTOM - PRE-2007 TRUCK MODELS - SOLD INDIVIDUALLY



PLAIN BOTTOM	
TSK10-52S 10" Diameter - 52" Middle Spool	TSK10-55S 10" Diameter - 55" Middle Spool
TSK8-52S 8" Diameter - 52" Middle Spool	TSK8-55S 8" Diameter - 55" Middle Spool
TSK7-52S 7" Diameter - 52" Middle Spool	TSK7-55S 7" Diameter - 55" Middle Spool
TSK6-52S 6" Diameter - 52" Middle Spool	TSK6-55S 6" Diameter - 55" Middle Spool

REDUCED TO 5" BOTTOM	
TSK75-52S 7" to 5" Reduced Diameter 52" Middle Spool	TSK75-55S 7" to 5" Reduced Diameter 55" Middle Spool
TSK65-52S 6" to 5" Reduced Diameter 52" Middle Spool	Part Not Available

IMPORTANT

For Peterbilt 379: Trucks between 1987-2003, use a 52" Middle Spool. From 2003-2006, use a 55" Middle Spool. (Some Peterbilt 379 Models built in late 2003 may need 52" Middle Spools)

Please measure the distance between your current upper & lower exhaust brackets for exact dimensions.

Attention! The above measurements are the length of each spool and do not include the additional tapered sleeve. If assembled correctly, the middle spool will measure either 52" or 55" in length.

IMPORTANT

The common 5" Outer Diameter Elbows will fit inside these Middle Spools.

For Peterbilt 379: Trucks between 1987-2003, use a 52" Middle Spool. From 2003-2006, use a 55" Middle Spool.

Please measure the distance between your current upper & lower exhaust brackets for exact dimensions.

Attention! The above measurements are the length of each spool and do not include the additional tapered sleeve. If assembled correctly, the middle spool will measure either 52" or 55" in length.



EXHAUST

90° ELBOWS - REDUCED TO 5" O.D PRE-2007 TRUCK MODELS - SOLD INDIVIDUALLY

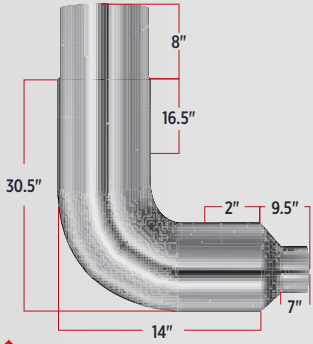

▲ 10" REDUCED TO 5" DIAMETER
TEL-105

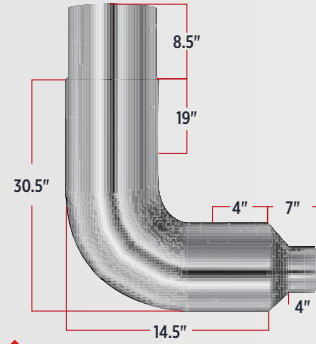

▲ 8" REDUCED TO 5" DIAMETER
TEL-85

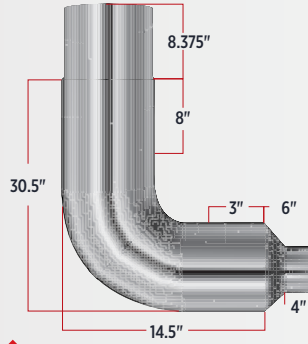

▲ 7" REDUCED TO 5" DIAMETER
TEL-75

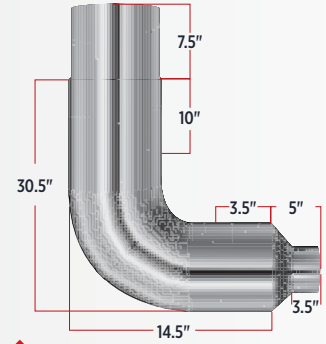

▲ 6" REDUCED TO 5" DIAMETER
TEL-65

TECHNICAL SPECIFICATIONS

MATERIAL	Chrome Plated Stainless Steel
SOLD	Individually
WARRANTY	1 Year

These elbows are sold with an additional tapered sleeve & is attached to the top of the elbow. This extra reduced sleeve fits INTO the bottom of any middle spool (corresponding to the correct diameter) offering the elbow extra support and strength.

90° ELBOWS - REDUCED TO 8" O.D PRE-2007 TRUCK MODELS - SOLD INDIVIDUALLY

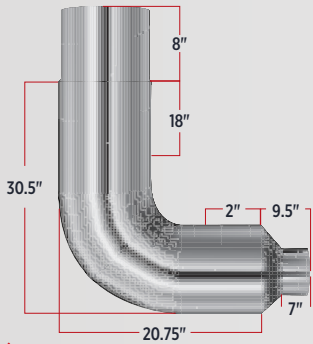

▲ 10" REDUCED TO 8" DIAMETER
TEL-10

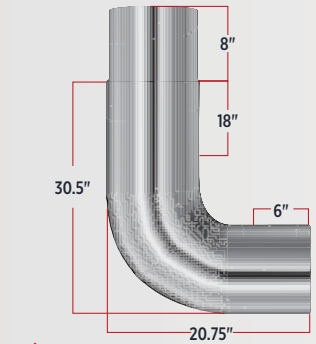

▲ 8" DIAMETER
TEL-8

TECHNICAL SPECIFICATIONS

MATERIAL	Chrome Plated Stainless Steel
SOLD	Individually
WARRANTY	1 Year

These elbows are sold with an additional tapered sleeve & is attached to the top of the elbow. This extra reduced sleeve fits INTO the bottom of any middle spool (corresponding to the correct diameter) offering the elbow extra support and strength.



▲ WARNING: Cancer and Reproductive Harm - www.p65warnings.ca.gov

58° ELBOWS - REDUCED TO 5" O.D

PRE-2007 TRUCK MODELS - SOLD INDIVIDUALLY

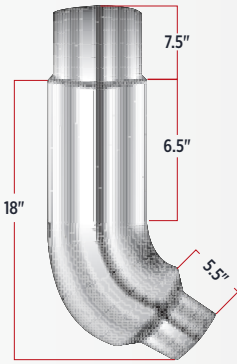

▲ 8" REDUCED TO 5" DIAMETER
TEL85-PET

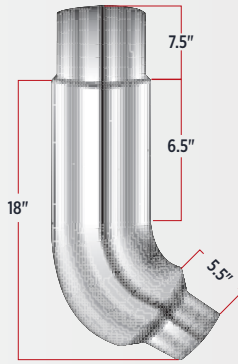

▲ 7" REDUCED TO 5" DIAMETER
TEL75-PET

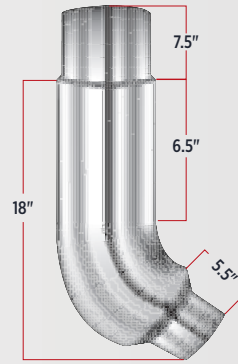

▲ 6" REDUCED TO 5" DIAMETER
TEL65-PET



▲ 5" DIAMETER
TEL55-PET

TECHNICAL SPECIFICATIONS

MATERIAL	Chrome Plated Stainless Steel
SOLD	Individually
WARRANTY	1 Year

These elbows are sold with an additional tapered sleeve & is attached to the top of the elbow. This extra reduced sleeve fits INTO the bottom of any middle spool (corresponding to the correct diameter) offering the elbow extra support and strength.



▲ WARNING: Cancer and Reproductive Harm - www.p65warnings.ca.gov

EXHAUST

5" O.D TOP STACKS PRE-2007 TRUCK MODELS - SOLD INDIVIDUALLY



36"
LONG

TSK5-M036
36" Mitered Top Stack

TSK5-C036
36" Curved Top Stack

TSK5-B036
36" Bullhorn Top Stack

48"
LONG

TSK5-M048
48" Mitered Top Stack

TSK5-C048
48" Curved Top Stack

TSK5-B048
48" Bullhorn Top Stack

60"
LONG

TSK5-M060
60" Mitered Top Stack

TSK5-C060
60" Curved Top Stack

TSK5-B060
60" Bullhorn Top Stack



TECHNICAL SPECIFICATIONS

MATERIAL	Chrome Plated Stainless Steel
SOLD	Individually
WARRANTY	1 Year



WARNING: Cancer and Reproductive Harm - www.p65warnings.ca.gov

REDUCED TO 5" O.D TOP STACKS

PRE-2007 TRUCK MODELS - SOLD INDIVIDUALLY



7" TO 5" REDUCED

TSK75-M048 7" to 5" Reduced Diameter 48" Mitered Top Stack	TSK75-C048 7" to 5" Reduced Diameter 48" Curved Top Stack	TSK75-B048 7" to 5" Reduced Diameter 48" Bullhorn Top Stack
TSK75-M060 7" to 5" Reduced Diameter 60" Mitered Top Stack	TSK75-C060 7" to 5" Reduced Diameter 60" Curved Top Stack	TSK75-B060 7" to 5" Reduced Diameter 60" Bullhorn Top Stack



6" TO 5" REDUCED

TSK65-M036 6" to 5" Reduced Diameter 36" Mitered Top Stack	TSK65-C036 6" to 5" Reduced Diameter 36" Curved Top Stack	TSK65-B036 6" to 5" Reduced Diameter 36" Bullhorn Top Stack
TSK65-M048 6" to 5" Reduced Diameter 48" Mitered Top Stack	TSK65-C048 6" to 5" Reduced Diameter 48" Curved Top Stack	TSK65-B048 6" to 5" Reduced Diameter 48" Bullhorn Top Stack
TSK65-M060 6" to 5" Reduced Diameter 60" Mitered Top Stack	TSK65-C060 6" to 5" Reduced Diameter 60" Curved Top Stack	TSK65-B060 6" to 5" Reduced Diameter 60" Bullhorn Top Stack



TECHNICAL SPECIFICATIONS

MATERIAL	Chrome Plated Stainless Steel
SOLD	Individually
WARRANTY	1 Year



TRUX'S RETAIL PACKAGING

INFORMATIVE, EYE-CATCHING RETAIL BOX

PROTECTING YOUR PURCHASE DURING TRANSIT

ALL OF TRUX'S EXHAUSTS KITS, TOP STACKS, SPOOLS & ACCESSORIES ARE SHIPPED IN HIGH QUALITY PACKAGING FOR YOUR CONVENIENCE

EXHAUST

LOWER EXHAUST BRACKETS STRAIGHT | ANGLED



▲
STRAIGHT BRACKET
TCLA-PEB



▲
ANGLED BRACKET
TCLA-PEBA

TECHNICAL SPECIFICATIONS

MATERIAL	Chrome Plated Stainless Steel
SOLD	Individually
WARRANTY	1 Year

Replaces the original Exhaust Bracket on the Cab corner.

BRACKET BUSHINGS 4 UNITS



▲
4 PACK
TP-2010

TECHNICAL SPECIFICATIONS

MATERIAL	Black Polyurethane
SOLD	Pack of 4
WARRANTY	1 Year

WIDE BAND CLAMPS STRAIGHT / ANGLED MOUNTING PLATE



▲
STRAIGHT MOUNTING PLATE
TCLA-51 5" Wide
TCLA-61 6" Wide



▲
ANGLED MOUNTING PLATE
TCLA-103 10" Wide
TCLA-83 8" Wide
TCLA-73 7" Wide
TCLA-63 6" Wide

TECHNICAL SPECIFICATIONS

MATERIAL	Chrome Plated Stainless Steel
SOLD	Individually
WARRANTY	1 Year

The clamp wraps around the Exhaust & attaches to the Mounting Bracket of the truck.



Y-PIPE FOR TRUX ELBOWS



▲
GALVANIZED STEEL
TSK-5Y 5" Wide
TSK-8Y 8" Wide

TECHNICAL SPECIFICATIONS

MATERIAL	Galvanized Steel
SOLD	Individually
WARRANTY	1 Year

TSK-5Y DESIGNED TO FIT	Trux Elbows: TEL85-PET, TEL75-PET, TEL65-PET, TEL55-PET, TEL-105, TEL-85, TEL-75, TEL-65
TSK-8Y DESIGNED TO FIT	Trux Elbows: TEL-8 & TEL-10

▲ WARNING: Cancer and Reproductive Harm - www.p65warnings.ca.gov

COMPLETE EXHAUST HARDWARE KITS
ALL-IN-ONE BOX OUTFITS ONE TRUCK



**ALL-IN-ONE
BOX!**

NO MORE LOOSE PARTS TO WORRY ABOUT!
THE TRUX ALL-IN-ONE BOX TAKES CARE
OF YOUR INVENTORY NEEDS.



WIDE BAND CLAMPS
(ANGLED OR STRAIGHT)

BRACKET BUSHINGS

LOWER EXHAUST BRACKETS
(ANGLED OR STRAIGHT)

TECHNICAL SPECIFICATIONS

SOLD	As a Kit
WARRANTY	1 Year

PART NUMBER	TSK10K	TSK8K	TSK7K	TSK6K	TSK5K
KIT INCLUDES	6 x 10" Angled Wide Band Clamps 4 x Angled Lower Exhaust Brackets 8 x Bracket Bushings	4 x 8" Angled Wide Band Clamps 2 x Angled Lower Exhaust Brackets 8 x Bracket Bushings	4 x 7" Angled Wide Band Clamps 2 x Angled Lower Exhaust Brackets 8 x Bracket Bushings	4 x 6" Angled Wide Band Clamps 2 x Angled Lower Exhaust Brackets 8 x Bracket Bushings	4 x 5" Straight Wide Band Clamps 2 x Straight Lower Exhaust Brackets 8 x Bracket Bushings

WARNING: Cancer and Reproductive Harm - www.p65warnings.ca.gov

PETERBILT SUN VISORS

14" BOWTIE HIGH & LOW ROOF SUN VISORS

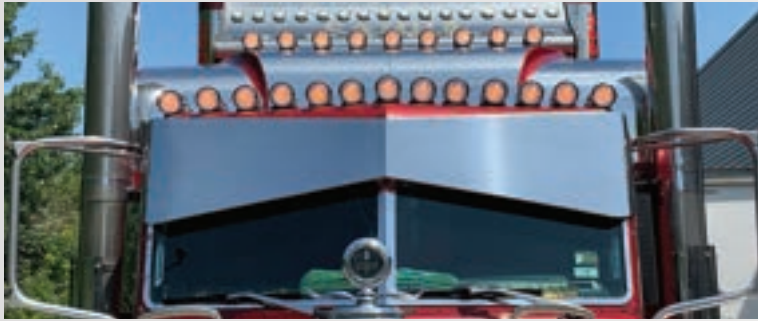

SOUTHERN STYLE
TSUN-P1 Stainless Steel
TSUN-P2 Paintable Aluminium

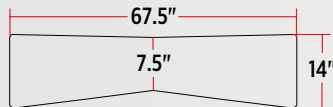

TECHNICAL SPECIFICATIONS

HIGH & LOW ROOF MODELS

379 & 378 (2005-2007) **389, 388, 386, 385, 384, 357, 340, 335 & 330** (2007+)

DIMENSIONS	Width: 67.5" Sides: 14" Drop: 7.5"
WHAT'S INCLUDED	1 x Sun Visor Bracket & Hardware
WARRANTY	1 Year

Visit our website at www.truxaccessories.com for Installation Instructions. Drilling will be required. For Trucks with Cab/Door Mounted Mirrors.

14" BOLTLESS HIGH ROOF SUN VISOR - 2005+



STAINLESS STEEL
TSUN-P14

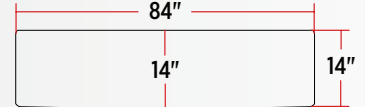

TECHNICAL SPECIFICATIONS

HIGH ROOF MODELS

PETERBILT MODELS (2005+)

DIMENSIONS	Width: 84" Sides: 14" Drop: 14"
WHAT'S INCLUDED	6 x Sun Visor Brackets & Hardware
WARRANTY	1 Year

Will NOT work on the new 1 Piece Windshields. Designed to fit OEM Stainless Steel Visors. Visit our website at www.truxaccessories.com for Installation Instructions.

14" BOLTLESS LOW ROOF SUN VISOR - 1987+



STAINLESS STEEL
TSUN-P25

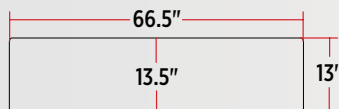

TECHNICAL SPECIFICATIONS

LOW ROOF MODELS

PETERBILT MODELS (1987+)

DIMENSIONS	Width: 66.5" Sides: 13" Drop: 13.5"
WHAT'S INCLUDED	6 x Sun Visor Brackets & Hardware
WARRANTY	1 Year

Visit our website at www.truxaccessories.com for Installation Instructions. Depending on Truck Year, Drilling may be required.

12" BOLTLESS BOWTIE LOW ROOF SUN VISOR - 1987+



STAINLESS STEEL
TSUN-P26



TECHNICAL SPECIFICATIONS

LOW ROOF MODELS

PETERBILT MODELS (1987+)

DIMENSIONS	Width: 71.25" Sides: 11.75" Drop: 5.5"
WHAT'S INCLUDED	4 x Sun Visor Brackets & Hardware
WARRANTY	1 Year

Visit our website at www.truxaccessories.com for Installation Instructions. Depending on Truck Year, Drilling may be required.

WARNING: Cancer and Reproductive Harm - www.p65warnings.ca.gov

13" LOW ROOF FLAT GLASS SUN VISOR - 2005+



STAINLESS STEEL
TSUN-P20



TECHNICAL SPECIFICATIONS

MODELS WITH CAB MOUNTED MIRRORS

389, 388, 386, 384, 379, 378, 367, 365, 357, 348, 340, 337, 335 & 330 (2005+)

DIMENSIONS	Width: 72" Sides: 16" Drop: 13"
WHAT'S INCLUDED	3 x Sun Visor Brackets & Hardware
WARRANTY	1 Year

Visit our website at www.truxaccessories.com for Installation Instructions. Depending on Truck Year, Drilling may be required.

15" V SHAPED LOW ROOF SUN VISOR - 2005+



STAINLESS STEEL
TSUN-P24

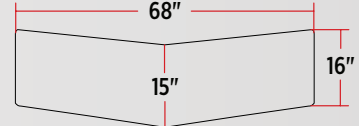

TECHNICAL SPECIFICATIONS

LOW ROOF MODELS

389, 388, 379, 378 & 367 (2005+)

DIMENSIONS	Width: 68" Sides: 16" Drop: 15"
WHAT'S INCLUDED	3 x Sun Visor Brackets & Hardware
WARRANTY	1 Year

Visit our website at www.truxaccessories.com for Installation Instructions. Depending on Truck Year, Drilling may be required.

15" HIGH ROOF CURVED GLASS SUN VISOR - 2000+



STAINLESS STEEL
TSUN-P28

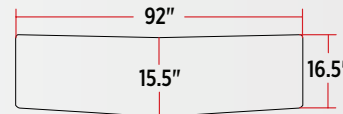

TECHNICAL SPECIFICATIONS

MODELS WITH DOOR MOUNTED MIRRORS

587 & 387 (2000+)

DIMENSIONS	Width: 92" Sides: 16.5" Drop: 15.5"
WHAT'S INCLUDED	3 x Sun Visor Brackets & Hardware
WARRANTY	1 Year

Visit our website at www.truxaccessories.com for Installation Instructions.

11" BOLTLESS WAVE HIGH ROOF SUN VISOR - 2002+



STAINLESS STEEL
TSUN-P30



TECHNICAL SPECIFICATIONS

HIGH ROOF MODELS

389, 388, 386, 384, 379, 378, 367, 365 & 357 (2002+)

DIMENSIONS	Width: 68" Sides: 10" Drop: 11"
WHAT'S INCLUDED	6 x Sun Visor Brackets & Hardware
WARRANTY	1 Year

Replaces OEM Sun Visor. Visit our website at www.truxaccessories.com for Installation Instructions.

PETERBILT SUN VISORS

14" HIGH ROOF FLAT GLASS SUN VISOR - PRE-2005



STAINLESS STEEL
TSUN-P8

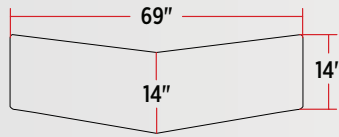

TECHNICAL SPECIFICATIONS

MODELS WITH DOOR MOUNTED MIRRORS

389, 388, 386, 384, 379, 378, 367, 365, 357, 348, 340, 337, 335 & 330 (Pre-2005)

DIMENSIONS	Width: 69" Sides: 14" Drop: 14"
WHAT'S INCLUDED	3 x Sun Visor Brackets & Hardware
WARRANTY	1 Year

Visit our website at www.truxaccessories.com for Installation Instructions.

14" HIGH ROOF FLAT GLASS SUN VISOR - 2005+



STAINLESS STEEL
TSUN-P11

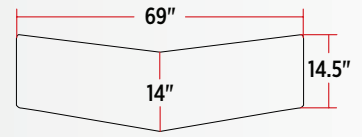

TECHNICAL SPECIFICATIONS

MODELS WITH CAB MOUNTED MIRRORS

389, 388, 386, 384, 379, 378, 367, 365, 357, 348, 340, 337, 335 & 330 (2005+)

DIMENSIONS	Width: 69" Sides: 14.5" Drop: 14"
WHAT'S INCLUDED	6 x Sun Visor Brackets & Hardware
WARRANTY	1 Year

Visit our website at www.truxaccessories.com for Installation Instructions.

13" LOW ROOF FLAT GLASS SUN VISOR - PRE-2005



STAINLESS STEEL
TSUN-P17



TECHNICAL SPECIFICATIONS

MODELS WITH DOOR MOUNTED MIRRORS

389, 388, 386, 384, 379, 378, 367, 365, 357, 348, 340, 337, 335 & 330 (Pre-2005)

DIMENSIONS	Width: 67" Sides: 13" Drop: 13"
WHAT'S INCLUDED	3 x Sun Visor Brackets & Hardware
WARRANTY	1 Year

Visit our website at www.truxaccessories.com for Installation Instructions.

15" HIGH ROOF SLEEPER SUN VISOR - 2013+



STAINLESS STEEL
TSUN-P27 5 x Slotted Holes
TSUN-P57 20 x 3/4" Holes

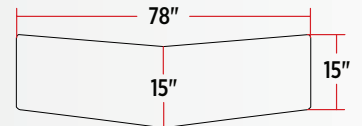

TECHNICAL SPECIFICATIONS

HIGH ROOF SLEEPER MODEL

579 (2013+)

DIMENSIONS	Width: 78" Sides: 15" Drop: 15"
WHAT'S INCLUDED	3 x Sun Visor Brackets & Hardware
WARRANTY	1 Year

Visit our website at www.truxaccessories.com for Installation Instructions.

WARNING: Cancer and Reproductive Harm - www.p65warnings.ca.gov

378 BUG DEFLECTOR HOOD SHIELD - ALL YEARS

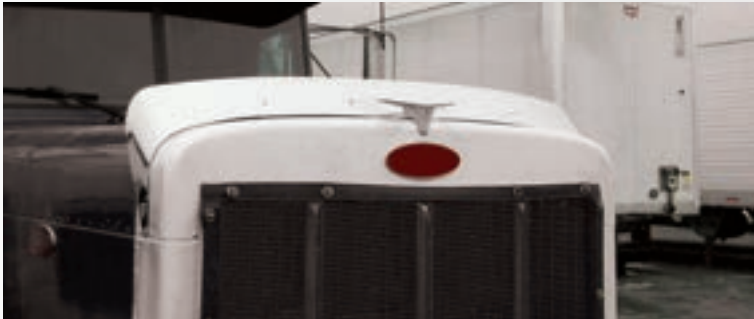

STAINLESS STEEL
THOD-PET3K

TECHNICAL SPECIFICATIONS

SHORT HOOD MODELS

378 (All Years)

DIMENSIONS	Width: 48"
WHAT'S INCLUDED	Hardware
WARRANTY	1 Year

Visit our website at www.truxaccessories.com for Installation Instructions.

379 BUG DEFLECTOR HOOD SHIELD - ALL YEARS



STAINLESS STEEL
THOD-PET379

TECHNICAL SPECIFICATIONS

PETERBILT MODEL

379 (All Years)

DIMENSIONS	Width: 43"
WHAT'S INCLUDED	Hardware
WARRANTY	1 Year

Visit our website at www.truxaccessories.com for Installation Instructions.

379 FRONT GRILLE OVAL PUNCH OUTS - ALL YEARS



STAINLESS STEEL
TP-1124 Long Hood Models
TP-1125 Short Hood Models

TECHNICAL SPECIFICATIONS

PETERBILT 379 MODELS

TP-1124 Long Hood (All Years) **TP-1125** Short Hood (All Years)

GAUGE	18 Gauge
DIMENSIONS	TP-1124: 42.25" x 33.75" TP-1125: 42.25" x 33.675"
WHAT'S INCLUDED	Hardware
WARRANTY	1 Year

Visit our website at www.truxaccessories.com for Installation Instructions.

WARNING: Cancer and Reproductive Harm - www.p65warnings.ca.gov

386/384 BUG DEFLECTOR HOOD SHIELD - 2006+



STAINLESS STEEL
THOD-PET386

TECHNICAL SPECIFICATIONS

PETERBILT MODELS

384 & 386 (2006+)

DIMENSIONS	Width: 47.5"
WHAT'S INCLUDED	Hardware
WARRANTY	1 Year

Drilling is required. Visit our website at www.truxaccessories.com for Installation Instructions.

PETERBILT BUG DEFLECTORS

389/388/367 BUG DEFLECTOR HOOD SHIELD - 2008+



STAINLESS STEEL
THOD-PET389

TECHNICAL SPECIFICATIONS

PETERBILT MODELS

389, 388 & 367 Heavy Haul (2008+)

DIMENSIONS	Width: 52"
WHAT'S INCLUDED	Hardware
WARRANTY	1 Year

Visit our website at www.truxaccessories.com for Installation Instructions.

389/388 FRONT GRILLE OVAL PUNCH OUT - ALL YEARS



STAINLESS STEEL
TP-1139

TECHNICAL SPECIFICATIONS

LONG HOOD MODELS

389 & 388 (All Years)

GAUGE	18 Gauge
DIMENSIONS	Width: 36" Height: 42"
WARRANTY	1 Year

Visit our website at www.truxaccessories.com for Installation Instructions.

567 BUG DEFLECTOR HOOD SHIELD - 2013+



STAINLESS STEEL
THOD-PET567

TECHNICAL SPECIFICATIONS

PETERBILT MODEL

567 (2013+)

DIMENSIONS	Width: 49.92"
WHAT'S INCLUDED	Hardware
WARRANTY	1 Year

Drilling is required. Visit our website at www.truxaccessories.com for Installation Instructions.

335/337/340/348 BUG DEFLECTOR HOOD SHIELD - ALL YEARS



STAINLESS STEEL
THOD-PET335

TECHNICAL SPECIFICATIONS

PETERBILT MODELS

335, 337, 340 & 348 (All Years)

DIMENSIONS	Width: 49.3"
WHAT'S INCLUDED	Hardware
WARRANTY	1 Year

Visit our website at www.truxaccessories.com for Installation Instructions.

 **WARNING: Cancer and Reproductive Harm - www.p65warnings.ca.gov**

579 BUG DEFLECTOR HOOD SHIELD - 2013+



STAINLESS STEEL
THOD-PET579

TECHNICAL SPECIFICATIONS

PETERBILT MODEL

579 (2013+)

DIMENSIONS	Width: 58"
WHAT'S INCLUDED	Hardware
WARRANTY	1 Year

Drilling is required. Visit our website at www.truxaccessories.com for Installation Instructions.

579 GRILLE SURROUND 2013+



STAINLESS STEEL
TP-1131

TECHNICAL SPECIFICATIONS

PETERBILT MODEL

579 (2013+)

WHAT'S INCLUDED	Hardware & 3M Tape (Double Side)
SOLD	As a Kit (4 Pieces)
WARRANTY	1 Year

Drilling is required. Visit our website at www.truxaccessories.com for Installation Instructions.

587 BUG DEFLECTOR HOOD SHIELD - 2011+



STAINLESS STEEL
THOD-PET587

TECHNICAL SPECIFICATIONS

PETERBILT MODEL

587 (2011+)

DIMENSIONS	Width: 51"
WHAT'S INCLUDED	Hardware
WARRANTY	1 Year

Visit our website at www.truxaccessories.com for Installation Instructions.

587/387 BUG DEFLECTOR HOOD SHIELD - 2000+



STAINLESS STEEL
THOD-PET387

TECHNICAL SPECIFICATIONS

PETERBILT MODELS

387 & 587 (2000+)

DIMENSIONS	Width: 54.4"
WHAT'S INCLUDED	Hardware
WARRANTY	1 Year

Visit our website at www.truxaccessories.com for Installation Instructions.

PETERBILT 379/378



- 430 Mirror Shine Stainless Steel
- LED Lighting
- 1 Year Warranty

- Hardware Included
- Pre-Wired & Assembled Kits*

*Depending on Part Number

FRONT AIR CLEANER LIGHT BARS STAINLESS STEEL

	PANEL SIZE	2" HOLES			3/4" HOLES		
FRONT STANDARD AIR CLEANERS 379 & 378 1987-2004	19.5" LONG	TP-1801 12 x 2" HOLES	TP-1801L 12 x TLED-2A	TP-1801LC 12 x TLED-2TA	-	-	-
FRONT STANDARD AIR CLEANERS 379 & 378 ALL YEARS	20.25" LONG 4.81" MOUNT	TP-1808 12 x 2" HOLES	TP-1808L 12 x TLED-2A	TP-1808LC 12 x TLED-2TA	-	-	-
FRONT STANDARD AIR CLEANERS 379 & 378 1987-2004	26" LONG	TP-1814 16 x 2" HOLES	TP-1814L 16 x TLED-2A	TP-1814LC 16 x TLED-2TA	TP-1863 20 x 3/4" HOLES	TP-1863L 20 x TLED-B2A	TP-1863LC 20 x TLED-B2CA
FRONT STANDARD AIR CLEANERS 379 & 378 ALL YEARS	27" LONG 4.81" MOUNT	TP-1820 16 x 2" HOLES	TP-1820L 16 x TLED-2A	TP-1820LC 16 x TLED-2TA	-	-	-

Attaches to the bracket between the Hood & Air Cleaner with existing hardware.



	PANEL SIZE	G2 HOLES			3/4" HOLES		
FRONT STANDARD AIR CLEANERS 379 & 378 1987+	19.5" LONG 1.5" MOUNT	TP-1852 12 x G2 HOLES	TP-1852LM 12 x TLED-G2A	TP-1852LMC 12 x TLED-G2CA	-	-	-
FRONT STANDARD AIR CLEANERS 379 & 378 2005-2007	25.5" LONG 6.5" MOUNT	TP-1855 16 x G2 HOLES	TP-1855LM 16 x TLED-G2A	TP-1855LMC 16 x TLED-G2CA	-	-	-
FRONT 15" STANDARD AIR CLEANERS 379 & 378 1987+	26" LONG 5.07" MOUNT	TP-1840 16 x G2 HOLES	TP-1840LM 16 x TLED-G2A	TP-1840LMC 16 x TLED-G2CA	-	-	-

Attaches to the bracket between the Hood & Air Cleaner with existing hardware.





 WARNING: Cancer and Reproductive Harm - www.p65warnings.ca.gov

REAR AIR CLEANER LIGHT BARS

STAINLESS STEEL

	PANEL SIZE	2" HOLES			3/4" HOLES		
REAR 13" STANDARD AIR CLEANERS 379 & 378 1987-2004	19.5" LONG	TP-1803 12 x 2" HOLES	TP-1803L 12 x TLED-2R	TP-1803LC 12 x TLED-2TR	-	-	-
REAR 15" STANDARD AIR CLEANERS 379 & 378 1987+	20.25" LONG 7.25" MOUNT	TP-1810 12 x 2" HOLES	TP-1810L 12 x TLED-2R	TP-1810LC 12 x TLED-2TR	-	-	-
REAR 13" STANDARD DONALDSON AIR CLEANERS 379 & 378 2005+	20.5" LONG 2.63" MOUNT	TP-1809 12 x 2" HOLES	TP-1809L 12 x TLED-2R	TP-1809LC 12 x TLED-2TR	-	-	-
REAR 15" STANDARD AIR CLEANERS 379 & 378 ALL YEARS	21.5" LONG	TP-1805 12 x 2" HOLES	TP-1805L 12 x TLED-2R	TP-1805LC 12 x TLED-2TR	-	-	-
REAR 13" STANDARD AIR CLEANERS 379 & 378 1987-2004	26" LONG	TP-1816 16 x 2" HOLES	TP-1816L 16 x TLED-2R	TP-1816LC 16 x TLED-2TR	-	-	-
REAR 15" STANDARD AIR CLEANERS 379 & 378 ALL YEARS	26" LONG	TP-1818 16 x 2" HOLES	TP-1818L 16 x TLED-2R	TP-1818LC 16 x TLED-2TR	TP-1864 20 x 3/4" HOLES	TP-1864L 20 x TLED-B2R	TP-1864LC 20 x TLED-B2CR
REAR 15" STANDARD AIR CLEANERS 379 & 378 1987-2004	27" LONG 7.25" MOUNT	TP-1822 16 x 2" HOLES	TP-1822L 16 x TLED-2R	TP-1822LC 16 x TLED-2TR	-	-	-
REAR 13"/15" STANDARD AIR CLEANERS 379 & 378 2005+	27.25" LONG 8" MOUNT	TP-1821 16 x 2" HOLES	TP-1821L 16 x TLED-2R	TP-1821LC 16 x TLED-2TR	-	-	-

Attaches to the bracket between the Cab & Air Cleaner with existing hardware.

	PANEL SIZE	G2 HOLES			3/4" HOLES		
REAR 13" STANDARD DONALDSON AIR CLEANERS 379 & 378 1987+	18.36" LONG 1.5" MOUNT	TP-1812 12 x G2 HOLES	TP-1812LM 12 x TLED-G2R	TP-1812LMC 12 x TLED-G2CR	-	-	-
REAR 15" STANDARD VORTEX AIR CLEANERS 379 & 378 1987-2004	24.48" LONG 7.31" MOUNT	TP-1857 16 x G2 HOLES	TP-1857LM 16 x TLED-G2R	TP-1857LMC 16 x TLED-G2CR	-	-	-
REAR 15" STANDARD AIR CLEANERS 379 & 378 1987+	18.36" LONG 4.59" MOUNT	TP-1868 12 x G2 HOLES	TP-1868LM 12 x TLED-G2R	TP-1868LMC 12 x TLED-G2CR	-	-	-

Attaches to the bracket between the Cab & Air Cleaner with existing hardware.

PETERBILT 379/378



- 430 Mirror Shine Stainless Steel
- LED Lighting
- 1 Year Warranty

- Hardware Included
- Pre-Wired & Assembled Kits*

*Depending on Part Number

LOWER HOOD PANEL STAINLESS STEEL

	PANEL WIDTH	BLANK	G4 HOLES			3/4" HOLES		
379 PRE-2007	-	TP-1109	-	-	-	-	-	-
						2" HOLES		
						-	-	-

COWL PANELS STAINLESS STEEL

	PANEL WIDTH	BLANK	G4 HOLES			3/4" HOLES		
379 & 378 ALL YEARS	3.5" WIDE	TP-1304	TP-1306 8 x G4 HOLES	TP-1306LM 8 x TLED-G4A	TP-1306LMC 8 x TLED-G4CA	TP-13126 12 x 3/4" HOLES	TP-13126L 12 x TLED-B2A	TP-13126LC 12 x TLED-B2CA
						2" HOLES		
						TP-1305 8 x 2" HOLES	TP-1305L 8 x TLED-2A	TP-1305LC 8 x TLED-2TA

Depending on Model Year, Drilling may be required.





 WARNING: Cancer and Reproductive Harm - www.p65warnings.ca.gov

CAB PANELS STAINLESS STEEL

	PANEL WIDTH	BLANK	G4 HOLES			3/4" HOLES		
379 & 378 ALL YEARS NO BLOCK HEATER	3.5" WIDE	TP-1301	TP-1303 6 x G4 HOLES	TP-1303LM 6 x TLED-G4A	TP-1303LMC 6 x TLED-G4CA	TP-13110 28 x 3/4" HOLES	TP-13110L 28 x TLED-B2A	TP-13110LC 28 x TLED-B2CA
						2" HOLES		
						TP-1302 10 x 2" HOLES	TP-1302L 10 x TLED-2A	TP-1302LC 10 x TLED-2TA

78" (OLD 70") SLEEPER WITH EXTENDERS STAINLESS STEEL

	PANEL WIDTH	BLANK	G4 HOLES			3/4" HOLES		
78" SLEEPER (OLD 70" SIZE) 379 & 378 1993+	3.5" WIDE	TP-1504	TP-1506 12 x G4 HOLES	TP-1506LM 12 x TLED-G4A	TP-1506LMC 12 x TLED-G4CA	-	-	-
						2" HOLES		
						TP-1505 16 x 2" HOLES	TP-1505L 16 x TLED-2A	TP-1505LC 16 x TLED-2TA

	PANEL WIDTH	BLANK	G4 HOLES			3/4" HOLES		
78" SLEEPER (OLD 70" SIZE) 379 & 378 ALL YEARS	4" WIDE	-	-	-	-	TP-15132 28 x 3/4" HOLES	TP-15132L 28 x TLED-B2A	TP-15132LC 28 x TLED-B2CA
						2" HOLES		
						-	-	-

Fits 78" Sleepers (Old 70" sleeper size) with extension. To be used with an Extension Panel or End Cap. Drilling may be required. Hardware is included.

72" (OLD 63") SLEEPER WITH EXTENDERS STAINLESS STEEL

	PANEL WIDTH	BLANK	G4 HOLES			3/4" HOLES		
72" SLEEPER (OLD 63" SIZE) 379 & 378 ALL YEARS	3.5" WIDE	TP-1501	TP-1503 10 x G4 HOLES	TP-1503LM 10 x TLED-G4A	TP-1503LMC 10 x TLED-G4CA	TP-15128 36 x 3/4" HOLES	TP-15128L 36 x TLED-B2A	TP-15128LC 36 x TLED-B2CA
						2" HOLES		
						TP-1502 16 x 2" HOLES	TP-1502L 16 x TLED-2A	TP-1502LC 16 x TLED-2TA

Fits 72" Sleepers (Old 63" sleeper size) with extension. To be used with an Extension Panel or End Cap. Drilling may be required. Hardware is included.

58" (OLD 48") SLEEPER WITH EXTENDERS STAINLESS STEEL

	PANEL WIDTH	BLANK	G4 HOLES			3/4" HOLES		
58" SLEEPER (OLD 48" SIZE) 379 & 378 ALL YEARS	3.5" WIDE	TP-1510	TP-1512 8 x G4 HOLES	TP-1512LM 8 x TLED-G4A	TP-1512LMC 8 x TLED-G4CA	-	-	-
						2" HOLES		
						TP-1511 10 x 2" HOLES	TP-1511L 10 x TLED-2A	TP-1511LC 10 x TLED-2TA

Fits 58" Sleepers (Old 48" sleeper size) with extension. To be used with an Extension Panel or End Cap. Drilling may be required. Hardware is included.

 **WARNING: Cancer and Reproductive Harm - www.p65warnings.ca.gov**

PETERBILT 379/378

EXTENDER PANELS STAINLESS STEEL

	PANEL WIDTH	BLANK	G4 HOLES			3/4" HOLES		
78" SLEEPER (OLD 70" SIZE) 379 & 378 ALL YEARS	3.5" WIDE	TP-1516	TP-1518 2 x G4 HOLES	TP-1518LM 2 x TLED-G4A	TP-1518LMC 2 x TLED-G4CA	-	-	-
						2" HOLES		
						TP-1517 4 x 2" HOLES	TP-1517L 4 x TLED-2A	TP-1517LC 4 x TLED-2TA

Fits 78" Sleepers (Old 70" sleeper size) with extension. Drilling may be required. Hardware is included. Is designed to continue the Sleeper Kit to the end of the Sleeper.

	PANEL WIDTH	BLANK	G4 HOLES			3/4" HOLES		
78" SLEEPER (OLD 70" SIZE) 379 & 378 ALL YEARS	4" WIDE	-	-	-	-	TP-15140 4 x 3/4" HOLES	TP-15140L 4 x TLED-B2A	TP-15140LC 4 x TLED-B2CA

Fits 78" Sleepers (Old 70" sleeper size) with extension. Drilling may be required. Hardware is included. Is designed to continue the Sleeper Kit to the end of the Sleeper.

	PANEL WIDTH	BLANK	G4 HOLES			3/4" HOLES		
44"/58"/72" SLEEPER (36"/48"/63" OLD SIZE) 379 & 378 ALL YEARS	3.5" WIDE	TP-1513	TP-1515 2 x G4 HOLES	TP-1515LM 2 x TLED-G4A	TP-1515LMC 2 x TLED-G4CA	TP-15129 14 x 3/4" HOLES	TP-15129L 14 x TLED-B2A	TP-15129LC 14 x TLED-B2CA
						2" HOLES		
						TP-1514 6 x 2" HOLES	TP-1514L 6 x TLED-2A	TP-1514LC 6 x TLED-2TA

Fits 72"/58"/44" Sleepers (OLD 63"/48"/36" sleeper size) with extension. Drilling may be required. Hardware is included. Is designed to continue the Sleeper Kit to the end of the Sleeper.



SOUTHERN STYLE 6" / 9" WIDE PANELS

- 430 Mirror Shine Stainless Steel
- LED Lighting
- 1 Year Warranty
- Hardware Included
- Pre-Wired & Assembled Kits*

*Depending on Part Number

6" WIDE COWL, CAB & SLEEPER KITS STAINLESS STEEL

	PANEL WIDTH	BLANK	G4 HOLES			3/4" HOLES		
6" WIDE 78" SLEEPERS (OLD 70" SIZE) 379 & 378 1993-2007	6" WIDE	TP-1009	TP-1064 34 x G4 HOLES	TP-1064LM 34 x TLED-G4A	TP-1064LMC 34 x TLED-G4CA	-	-	-

Fits 78" Sleepers (Old 70" sleeper size). Drilling may be required. Hardware is included.

6" WIDE 72" SLEEPERS (OLD 63" SIZE) 379 & 378 1993-2007	6" WIDE	TP-1007	TP-1062 30 x G4 HOLES	TP-1062LM 30 x TLED-G4A	TP-1062LMC 30 x TLED-G4CA	-	-	-
-------------------------------------------------------------------------	---------	---------	--------------------------	----------------------------	------------------------------	---	---	---

Fits 72" Sleepers (Old 63" sleeper size). Drilling may be required. Hardware is included.

 **WARNING: Cancer and Reproductive Harm** - www.p65warnings.ca.gov

9" WIDE COWL, CAB & SLEEPER KITS STAINLESS STEEL

	PANEL WIDTH	BLANK	G4 HOLES			3/4" HOLES		
9" WIDE 78" SLEEPERS (OLD 70" SIZE) 379 & 378 1993-2007	9" WIDE	TP-1005	-	-	-	-	-	-

Fits 78" Sleepers (Old 70" sleeper size) with extension. Drilling may be required. Hardware is included.

9" WIDE 72" SLEEPERS (OLD 63" SIZE) 379 & 378 1993-2007	9" WIDE	TP-1003	TP-1065 24 x G4 HOLES	TP-1065LM 24 x TLED-G4A	TP-1065LMC 24 x TLED-G4CA	TP-10221 42 x 3/4" HOLES	TP-10221L 42 x TLED-B2A	TP-10221LC 42 x TLED-B2CA
-----------------------------------------------------------------------------	---------	----------------	---------------------------------	-----------------------------------	-------------------------------------	------------------------------------	-----------------------------------	-------------------------------------

Fits 72" Sleepers (Old 63" sleeper size) with extension. Drilling may be required. Hardware is included.

6" WIDE COWL, CAB, SLEEPER & EXTENDER KITS STAINLESS STEEL

	PANEL WIDTH	BLANK	G4 HOLES			3/4" HOLES		
6" WIDE 78" SLEEPERS (OLD 70" SIZE) 379 & 378 1993-2007	6" WIDE	TP-1091	-	-	-	TP-10220 48 x 3/4" HOLES	TP-10220L 48 x TLED-B2A	TP-10220LC 48 x TLED-B2CA

Fits 78" Sleepers (Old 70" sleeper size) with extension. Drilling may be required. Hardware is included.

6" WIDE 72" SLEEPERS (OLD 63" SIZE) 379 & 378 1993-2007	6" WIDE	TP-1090	TP-1063 34 x G4 HOLES	TP-1063LM 34 x TLED-G4A	TP-1063LMC 34 x TLED-G4CA	-	-	-
-----------------------------------------------------------------------------	---------	----------------	---------------------------------	-----------------------------------	-------------------------------------	---	---	---

Fits 72" Sleepers (Old 63" sleeper size) with extension. Drilling may be required. Hardware is included.

9" WIDE COWL, CAB, SLEEPER & EXTENDER KITS STAINLESS STEEL

	PANEL WIDTH	BLANK	G4 HOLES			3/4" HOLES		
9" WIDE 78" SLEEPERS (OLD 70" SIZE) 379 & 378 1993-2007	9" WIDE	TP-1093	TP-1067 28 x G4 HOLES	TP-1067LM 28 x TLED-G4A	TP-1067LMC 28 x TLED-G4CA	TP-10195 46 x 3/4" HOLES	TP-10195L 46 x TLED-B2A	TP-10195LC 46 x TLED-B2CA

Fits 78" Sleepers (Old 70" sleeper size) with extension. Drilling may be required. Hardware is included.

9" WIDE 72" SLEEPERS (OLD 63" SIZE) 379 & 378 1993-2007	9" WIDE	TP-1092	TP-1066 28 x G4 HOLES	TP-1066LM 28 x TLED-G4A	TP-1066LMC 28 x TLED-G4CA	-	-	-
-----------------------------------------------------------------------------	---------	----------------	---------------------------------	-----------------------------------	-------------------------------------	---	---	---

Fits 72" Sleepers (Old 63" sleeper size) with extension. Drilling may be required. Hardware is included.

PETERBILT 389



- 430 Mirror Shine Stainless Steel
- LED Lighting
- 1 Year Warranty

- Hardware Included
- Pre-Wired & Assembled Kits*

*Depending on Part Number

FRONT AIR CLEANER LIGHT BARS STAINLESS STEEL

	PANEL SIZE	2" HOLES			3/4" HOLES		
FRONT STANDARD AIR CLEANERS 389 ALL YEARS	20.25" LONG 4.81" MOUNT	TP-1808 12 x 2" HOLES	TP-1808L 12 x TLED-2A	TP-1808LC 12 x TLED-2TA	-	-	-
FRONT 15" PREMIUM AIR CLEANERS 389 & 388 2005+	22.25" LONG 6.4" MOUNT	TP-1847 12 x 2" HOLES	TP-1847L 12 x TLED-2A	TP-1847LC 12 x TLED-2TA	-	-	-
FRONT STANDARD AIR CLEANERS 389 ALL YEARS	26" LONG	-	-	-	TP-1863 20 x 3/4" HOLES	TP-1863L 20 x TLED-B2A	TP-1863LC 20 x TLED-B2CA
FRONT STANDARD AIR CLEANERS 389 & 388 ALL YEARS	27" LONG 4.81" MOUNT	TP-1820 16 x 2" HOLES	TP-1820L 16 x TLED-2A	TP-1820LC 16 x TLED-2TA	-	-	-
FRONT 15" PREMIUM AIR CLEANERS 389 & 388 2010+	27.88" LONG 5.63" MOUNT	TP-1846 16 x 2" HOLES	TP-1846L 16 x TLED-2A	TP-1846LC 16 x TLED-2TA	-	-	-

Attaches to the bracket between the Hood & Air Cleaner with existing hardware.

	PANEL SIZE	G2 HOLES			3/4" HOLES		
FRONT STANDARD AIR CLEANERS 389 & 388 ALL YEARS	19.5" LONG 1.5" MOUNT	TP-1852 12 x G2 HOLES	TP-1852LM 12 x TLED-G2A	TP-1852LMC 12 x TLED-G2CA	-	-	-
FRONT 15" PREMIUM AIR CLEANERS 389 & 388 2010+	22.38" LONG 5.5" MOUNT	TP-1853 14 x G2 HOLES	TP-1853LM 14 x TLED-G2A	TP-1853LMC 14 x TLED-G2CA	TP-1865 12 x 3/4" HOLES	TP-1865L 12 x TLED-B2A	TP-1865LC 12 x TLED-B2CA





Attaches to the bracket between the Hood & Air Cleaner with existing hardware.

 WARNING: Cancer and Reproductive Harm - www.p65warnings.ca.gov

FRONT AIR CLEANER LIGHT BARS STAINLESS STEEL

	PANEL SIZE	G2 HOLES			3/4" HOLES		
FRONT STANDARD AIR CLEANERS 389 & 388 2005-2007	25.5" LONG 6.5" MOUNT	TP-1855 16 x G2 HOLES	TP-1855LM 16 x TLED-G2A	TP-1855LMC 16 x TLED-G2CA	-	-	-
FRONT 15" STANDARD AIR CLEANERS 389 & 388 ALL YEARS	26" LONG 5.07" MOUNT	TP-1840 16 x G2 HOLES	TP-1840LM 16 x TLED-G2A	TP-1840LMC 16 x TLED-G2CA	-	-	-

REAR AIR CLEANER LIGHT BARS STAINLESS STEEL

	PANEL SIZE	2" HOLES			3/4" HOLES		
REAR 15" STANDARD AIR CLEANERS 389 & 388 ALL YEARS	20.25" LONG 7.25" MOUNT	TP-1810 12 x 2" HOLES	TP-1810L 12 x TLED-2R	TP-1810LC 12 x TLED-2TR	-	-	-
REAR 13" STANDARD AIR CLEANERS 389 & 388 2005+	20.5" LONG 2.63" MOUNT	TP-1809 12 x 2" HOLES	TP-1809L 12 x TLED-2R	TP-1809LC 12 x TLED-2TR	-	-	-
REAR 15" PREMIUM AIR CLEANERS 389 & 388 2010+	22" LONG 5.5" MOUNT	-	-	-	TP-1866 12 x 3/4" HOLES	TP-1866L 12 x TLED-B2R	TP-1866LC 12 x TLED-B2CR
REAR 15" STANDARD AIR CLEANERS 389 ALL YEARS	26" LONG	-	-	-	TP-1864 20 x 3/4" HOLES	TP-1864L 20 x TLED-B2R	TP-1864LC 20 x TLED-B2CR
REAR 15" STANDARD AIR CLEANERS 389 & 388 1987-2004	27" LONG 7.25" MOUNT	TP-1822 16 x 2" HOLES	TP-1822L 16 x TLED-2R	TP-1822LC 16 x TLED-2TR	-	-	-
REAR 15" PREMIUM FLANGELESS AIR CLEANERS 389 & 388 2010+	27.25" LONG 7.25" MOUNT	TP-1867 16 x 2" HOLES	TP-1867L 16 x TLED-2R	TP-1867LC 16 x TLED-2TR	-	-	-
REAR 13"/15" STANDARD AIR CLEANERS 389 & 388 2005+	27.25" LONG 8" MOUNT	TP-1821 16 x 2" HOLES	TP-1821L 16 x TLED-2R	TP-1821LC 16 x TLED-2TR	-	-	-

Attaches to the bracket between the Cab & Air Cleaner with existing hardware.

	PANEL SIZE	G2 HOLES			3/4" HOLES		
REAR 15" STANDARD AIR CLEANERS 389 & 388 ALL YEARS	18.36" LONG 1.5" MOUNT	TP-1868 12 x G2 HOLES	TP-1868LM 12 x TLED-G2R	TP-1868LMC 12 x TLED-G2CR	-	-	-
REAR 15" PREMIUM AIR CLEANERS 389 & 388 2010+	22.38" LONG 5.5" MOUNT	TP-1854 14 x G2 HOLES	TP-1854LM 14 x TLED-G2R	TP-1854LMC 14 x TLED-G2CR	-	-	-
REAR 15" STANDARD VORTEX AIR CLEANERS 389 & 388 1987-2004	24.48" LONG 7.31" MOUNT	TP-1857 16 x G2 HOLES	TP-1857LM 16 x TLED-G2R	TP-1857LMC 16 x TLED-G2CR	-	-	-

Attaches to the bracket between the Cab & Air Cleaner with existing hardware.

 **WARNING:** Cancer and Reproductive Harm - www.p65warnings.ca.gov

PETERBILT 389





- 430 Mirror Shine Stainless Steel
- LED Lighting
- 1 Year Warranty

- Hardware Included
- Pre-Wired & Assembled Kits*

*Depending on Part Number

DELUXE COWL PANELS STAINLESS STEEL

	PANEL WIDTH	BLANK	G4 HOLES			3/4" HOLES		
LONG HOOD WITH STEP DPF (131" BBC) 389 2014-2017 FOR 3" WIDE PANELS	-	TP-13100	TP-1396 10 x G4 HOLES	TP-1396LM 10 x TLED-G4A	TP-1396LMC 10 x TLED-G4CA	-	-	-





Passenger Side Cutout accommodates for DPF. Designed to fit with 3" Cab Panels. Install using supplied Hardware.

	PANEL WIDTH	BLANK	G4 HOLES			3/4" HOLES		
LONG HOOD WITH STEP DPF (131" BBC) 389 2014-2017 FOR 4" WIDE PANELS	-	-	-	-	-	TP-13120 10 x 3/4" HOLES	TP-13120L 10 x TLED-B2A	TP-13120LC 10 x TLED-B2CA

Passenger Side Cutout accommodates for DPF. Designed to fit with 4" Cab Panels. Install using supplied Hardware.

 WARNING: Cancer and Reproductive Harm - www.p65warnings.ca.gov

DELUXE COWL PANELS STAINLESS STEEL

	PANEL WIDTH	BLANK	G4 HOLES			3/4" HOLES		
LONG HOOD (131" BBC) 389 2018+ FOR 4" PANELS	-	TP-13150	TP-13159 8 x G4 HOLES	TP-13159LM 8 x TLED-G4A	TP-13159LMC 8 x TLED-G4CA	TP-13170 10 x 3/4" HOLES	TP-13170L 10 x TLED-B2A	TP-13170LC 10 x TLED-B2CA

Use with 4" Wide Deluxe Cab & Sleeper Panels for 2018+ Models. Install using supplied Hardware.



DELUXE CAB PANELS STAINLESS STEEL

	PANEL WIDTH	BLANK	G4 HOLES			3/4" HOLES		
LONG HOOD (131" BBC) 389 2014-2017 NO BLOCK HEATER	3" WIDE DRIVER SIDE	TP-13101	TP-1398 4 x G4 HOLES DRIVER SIDE	TP-1398LM 4 x TLED-G4A DRIVER SIDE	TP-1398LMC 4 x TLED-G4CA DRIVER SIDE	TP-13121 12 x 3/4" HOLES	TP-13121L 12 x TLED-B2A	TP-13121LC 12 x TLED-B2CA

Driver Side measures 3" Wide. Passenger Side measures 1.75" Wide. Drilling may be required.

	PANEL WIDTH	BLANK	G4 HOLES			3/4" HOLES		
LONG HOOD (131" BBC) 389 2018+ NO BLOCK HEATER	4" WIDE DRIVER SIDE	TP-13149	TP-13168 3 x G4 HOLES DRIVER SIDE	TP-13168LM 3 x TLED-G4A DRIVER SIDE	TP-13168LMC 3 x TLED-G4CA DRIVER SIDE	TP-13169 6 x 3/4" HOLES DRIVER SIDE	TP-13169L 6 x TLED-B2A DRIVER SIDE	TP-13169LC 6 x TLED-B2CA DRIVER SIDE

Driver Side measures 4" Wide, 37.85" Long. Passenger Side measures 0.82" tapering to 1.58" Wide & 43.57" Long. NOT to be used with OEM Cowl/Hood Extension Panels.

OEM COWL PANELS STAINLESS STEEL

	PANEL WIDTH	BLANK	G4 HOLES			3/4" HOLES		
LONG HOOD (131" BBC) 389 2007-2017	-	TP-1310	-	-	-	-	-	-





Installs over the OEM Cowl using supplied hardware.

PETERBILT 389

OEM CAB PANELS STAINLESS STEEL

	PANEL WIDTH	BLANK	G4 HOLES			3/4" HOLES		
LONG HOOD (131" BBC) 389 2014-2017 NO BLOCK HEATER	3" WIDE	TP-13102	TP-1397 6 x G4 HOLES	TP-1397LM 6 x TLED-G4A	TP-1397LMC 6 x TLED-G4CA	TP-13116 14 x 3/4" HOLES	TP-13116L 14 x TLED-B2A	TP-13116LC 14 x TLED-B2CA

For use with OEM Cowl Panels. Some drilling is required.

	PANEL WIDTH	BLANK	G4 HOLES			3/4" HOLES		
LONG HOOD (131" BBC) 389 2018+ NO BLOCK HEATER	4" WIDE DRIVER SIDE	TP-13171	TP-13166 3 x G4 HOLES DRIVER SIDE	TP-13166LM 3 x TLED-G4A DRIVER SIDE	TP-13166LMC 3 x TLED-G4CA DRIVER SIDE	TP-13167 14 x 3/4" HOLES	TP-13167L 14 x TLED-B2A	TP-13167LC 14 x TLED-B2CA

Driver Side measures 4" Wide & 42.85" Long. Passenger Side measures 1.25" Wide & 42.88" Long. To be installed with OEM Cowl Panels using supplied hardware.

SLEEPER WITHOUT EXTENDERS STAINLESS STEEL

	PANEL WIDTH	BLANK	G4 HOLES			3/4" HOLES		
72" SLEEPERS (OLD 63" SIZE) LONG HOOD (131" BBC) 389 2014-2017	3" WIDE	TP-15158	-	-	-	-	-	-
72" SLEEPERS (OLD 63" SIZE) LONG HOOD (131" BBC) 389 2007-2017 SHORT HOOD (123" BBC) 389 & 388 2007+	4" WIDE	-	TP-1588 8 x G4 HOLES	TP-1588LM 8 x TLED-G4A	TP-1588LMC 8 x TLED-G4CA	TP-15156 18 x 3/4" HOLES	TP-15156L 18 x TLED-B2A	TP-15156LC 18 x TLED-B2CA
72" SLEEPERS (OLD 63" SIZE) WITH WRAP LONG HOOD (131" BBC) 389 2018+	4" WIDE	TP-15211	TP-15208 8 x G4 HOLES	TP-15208LM 8 x TLED-G4A	TP-15208LMC 8 x TLED-G4CA	TP-15212 18 x 3/4" HOLES	TP-15212L 18 x TLED-B2A	TP-15212LC 18 x TLED-B2CA

Fits 72" Sleepers (Old 63" sleeper size) without Extension. Drilling may be required. Hardware is included.





58" SLEEPERS (OLD 48" SIZE) LONG HOOD (131" BBC) 389 2007-2017 SHORT HOOD (123" BBC) 389 & 388 2007+	4" WIDE	TP-1583	TP-1585 6 x G4 HOLES	TP-1585LM 6 x TLED-G4A	TP-1585LMC 6 x TLED-G4CA	TP-15152 14 x 3/4" HOLES	TP-15152L 14 x TLED-B2A	TP-15152LC 14 x TLED-B2CA
58" SLEEPERS (OLD 48" SIZE) WITH WRAP LONG HOOD (131" BBC) 389 2018+	4" WIDE	TP-15214	TP-15207 6 x G4 HOLES	TP-15207LM 6 x TLED-G4A	TP-15207LMC 6 x TLED-G4CA	TP-15215 14 x 3/4" HOLES	TP-15215L 14 x TLED-B2A	TP-15215LC 14 x TLED-B2CA

Fits 58" Sleepers (Old 48" sleeper size) without Extension. Drilling may be required. Hardware is included.

 **WARNING:** Cancer and Reproductive Harm - www.p65warnings.ca.gov

78" (OLD 70") SLEEPER WITH EXTENDERS

STAINLESS STEEL

	PANEL WIDTH	BLANK	G4 HOLES			3/4" HOLES		
78" SLEEPERS (OLD 70" SIZE) 389 & 388 2014-2017	3" WIDE	TP-15159	-	-	-	-	-	-
78" SLEEPERS (OLD 70" SIZE) LONG HOOD (131" BBC) 389 & 388 2007-2017 SHORT HOOD (123" BBC) 389 & 388 2007+	4" WIDE	-	-	-	-	TP-15139 22 x 3/4" HOLES	TP-15139L 22 x TLED-B2A	TP-15139LC 2 x TLED-B2CA
78" SLEEPERS (OLD 70" SIZE) LONG HOOD (131" BBC) 389 2007-2017 SHORT HOOD (123" BBC) 389 & 388 2007+	4" WIDE	-	TP-1571 10 x G4 HOLES	TP-1571LM 10 x TLED-G4A	TP-1571LMC 10 x TLED-G4CA	-	-	-
78" SLEEPERS (OLD 70" SIZE) LONG HOOD (131" BBC) 389 2018+	4" WIDE	TP-15209	TP-15205 10 x G4 HOLES	TP-15205LM 10 x TLED-G4A	TP-15205LMC 10 x TLED-G4CA	TP-15210 22 x 3/4" HOLES	TP-15210L 22 x TLED-B2A	TP-15210LC 22 x TLED-B2CA

Fits 78" Sleepers (Old 70" sleeper size) with extension. To be used with an Extension Panel or End Cap. Drilling may be required. Hardware is included.

72" (OLD 63") SLEEPER WITH EXTENDERS

STAINLESS STEEL

	PANEL WIDTH	BLANK	G4 HOLES			3/4" HOLES		
72" SLEEPERS (OLD 63" SIZE) 389 & 388 2014-2017	3" WIDE	TP-15160	TP-15120 14 x G4 HOLES	TP-15120LM 10 x TLED-G4A	TP-15120LMC 10 x TLED-G4CA	-	-	-
72" SLEEPERS (OLD 63" SIZE) LONG HOOD (131" BBC) 389 2007-2017 SHORT HOOD (123" BBC) 389 & 388 2007-2017	4" WIDE	-	-	-	-	TP-15201 18 x 3/4" HOLES	TP-15201L 18 x TLED-B2A	TP-15201LC 18 x TLED-B2CA
72" SLEEPERS (OLD 63" SIZE) LONG HOOD (131" BBC) 389 2018+	4" WIDE	TP-15213	TP-15204 8 x G4 HOLES	TP-15204LM 8 x TLED-G4A	TP-15204LMC 8 x TLED-G4CA	-	-	-

Fits 72" Sleepers (Old 63" sleeper size) with extension. To be used with an Extension Panel or End Cap. Drilling may be required. Hardware is included.

PETERBILT 389

58" (OLD 48") SLEEPER WITH EXTENDER STAINLESS STEEL

	PANEL WIDTH	BLANK	G4 HOLES			3/4" HOLES		
58" SLEEPERS (OLD 48" SIZE) LONG HOOD (131" BBC) 389 2007-2017 SHORT HOOD (123" BBC) 389 & 388 2007+	4" WIDE	TP-1595	-	-	-	TP-15200 14 x 3/4" HOLES	TP-15200L 14 x TLED-B2A	TP-15200LC 14 x TLED-B2CA
58" SLEEPERS (OLD 48" SIZE) LONG HOOD (131" BBC) 389 2014-2017	3" WIDE	-	TP-15185 10 x G4 HOLES	TP-15185LM 10 x TLED-G4A	TP-15185LMC 10 x TLED-G4CA	-	-	-
58" SLEEPERS (OLD 48" SIZE) LONG HOOD (131" BBC) 389 2018+	4" WIDE	TP-15216	TP-15203 6 x G4 HOLES	TP-15203LM 6 x TLED-G4A	TP-15203LMC 6 x TLED-G4CA	-	-	-

Fits 58" Sleepers (Old 48" sleeper size) with extension. To be installed with Extension Panels.

78" (OLD 70") SLEEPERS EXTENDER PANELS FOR STAINLESS STEEL

	PANEL WIDTH	BLANK	G4 HOLES			3/4" HOLES		
78" SLEEPERS (OLD 70" SIZE) 389 2014-2017	3" WIDE	TP-15163	TP-15118 2 x G4 HOLES	TP-15118LM 2 x TLED-G4A	TP-15118LMC 2 x TLED-G4CA	-	-	-
78" SLEEPERS (OLD 70" SIZE) 389 & 388 2014-2017	4" WIDE	-	-	-	-	TP-15140 4 x 3/4" HOLES	TP-15140L 4 x TLED-B2A	TP-15140LC 4 x TLED-B2CA

Fits 78" Sleepers (Old 70" sleeper size) with extension. Drilling may be required. Hardware is included. Will NOT fit 2018+ Peterbilt 389 Long Hood Models.

EXTENSION PANELS FOR 72"/58"/44" SLEEPERS STAINLESS STEEL

	PANEL WIDTH	BLANK	G4 HOLES			3/4" HOLES		
72"/58"/44" SLEEPERS (63"/48"/36" OLD SIZE) 389 - 2014+ 388 - 2007+	3" WIDE	TP-15162	-	-	-	-	-	-
72"/58" SLEEPERS (OLD 63"/48" SIZE) 389 2014+	3" WIDE	TP-15137	TP-15119 6 x G4 HOLES	TP-15119LM 6 x TLED-G4A	TP-15119LMC 6 x TLED-G4CA	-	-	-

Fits 72"/58"/44" Sleepers (OLD 63"/48"/36" sleeper size) with extension. Drilling may be required. Hardware is included.

 WARNING: Cancer and Reproductive Harm - www.p65warnings.ca.gov



- 430 Mirror Shine Stainless Steel
- LED Lighting
- 1 Year Warranty

- Hardware Included
- Pre-Wired & Assembled Kits*

*Depending on Part Number

CAB, SLEEPER & EXTENSION KIT STAINLESS STEEL

	PANEL WIDTH	BLANK	SLIM HOLES			3/4" HOLES		
78" SLEEPERS (OLD 70" SIZE) WITH FAIRINGS 386 ALL YEARS	1 5/8" WIDE	-	TP-10107 24 x SLIM HOLES	TP-10107LF 24 x TLED-FG4A	TP-10107LFC 24 x TLED-FG4CA	TP-10215 62 x 3/4" HOLES	TP-10215L 62 x TLED-B2A	TP-10215 LC 62 x TLED-B2CA



 WARNING: Cancer and Reproductive Harm - www.p65warnings.ca.gov

PETERBILT 587



- 430 Mirror Shine Stainless Steel
- LED Lighting
- 1 Year Warranty

- Hardware Included
- Pre-Wired & Assembled Kits*

*Depending on Part Number

CAB, SLEEPER & EXTENSION KIT STAINLESS STEEL

	PANEL WIDTH	BLANK	G4 HOLES			3/4" HOLES		
75" SLEEPERS (OLD 70" SIZE) HIGH ROOF 389 2011+ BLOCK HEATER HOLE	5" WIDE	-	TP-10127 14 x G4 HOLES	TP-10127LM 14 x TLED-G4A	TP-10127LMC 14 x TLED-G4CA	-	-	-



 WARNING: Cancer and Reproductive Harm - www.p65warnings.ca.gov



- 430 Mirror Shine Stainless Steel
- LED Lighting
- 1 Year Warranty

- Hardware Included
- Pre-Wired & Assembled Kits*

*Depending on Part Number

CAB & 80" SLEEPER KITS WITHOUT EXTENSION LONG HOOD MODELS - STAINLESS STEEL

	PANEL WIDTH	BLANK	G4 HOLES			3/4" HOLES		
80" SLEEPERS UNDERBODY EXHAUST (123" BBC) 579 2013+ 1 BLOCK HEATER	2.5" WIDE	-	TP-10138 16 x G4 HOLES	TP-10138LM 16 x TLED-G4A	TP-10138LMC 16 x TLED-G4CA	-	-	-
80" SLEEPERS UNDERBODY EXHAUST (123" BBC) 579 2013+ 2 BLOCK HEATER	2.5" WIDE	TP-10168	-	-	-	-	-	-



 WARNING: Cancer and Reproductive Harm - www.p65warnings.ca.gov

PETERBILT 579

CAB & 72" SLEEPER KITS WITHOUT EXTENSION LONG HOOD MODELS - STAINLESS STEEL

	PANEL WIDTH	BLANK	G4 HOLES			3/4" HOLES		
72" SLEEPERS UNDERBODY EXHAUST (123" BBC) 579 2013+ 1 BLOCK HEATER	2.5" WIDE	-	TP-10120 14 x G4 HOLES	TP-10120LM 14 x TLED-G4A	TP-10120LMC 14 x TLED-G4CA	-	-	-
72" SLEEPERS UNDERBODY EXHAUST (123" BBC) 579 2013+ 2 BLOCK HEATER	2.5" WIDE	TP-10166	-	-	-	-	-	-

CAB & 44" SLEEPER KITS WITHOUT EXTENSION LONG HOOD MODELS - STAINLESS STEEL

	PANEL WIDTH	BLANK	G4 HOLES			3/4" HOLES		
44" SLEEPERS UNDERBODY EXHAUST (123" BBC) 579 2013+ NO BLOCK HEATER	2.5" WIDE	TP-10160	TP-10163 10 x G4 HOLES	TP-10163LM 10 x TLED-G4A	TP-10163LMC 10 x TLED-G4CA	-	-	-
44" SLEEPERS UNDERBODY EXHAUST (123" BBC) 579 2013+ 1 BLOCK HEATER	2.5" WIDE	TP-10161	TP-10164 10 x G4 HOLES	TP-10164LM 10 x TLED-G4A	TP-10164LMC 10 x TLED-G4CA	-	-	-
44" SLEEPERS UNDERBODY EXHAUST (123" BBC) 579 2013+ 2 BLOCK HEATER	2.5" WIDE	TP-10162	TP-10165 10 x G4 HOLES	TP-10165LM 10 x TLED-G4A	TP-10165LMC 10 x TLED-G4CA	-	-	-

CAB, 80" SLEEPER & EXTENSION KITS LONG HOOD MODELS - STAINLESS STEEL

	PANEL WIDTH	BLANK	G4 HOLES			3/4" HOLES		
80" SLEEPERS UNDERBODY EXHAUST (123" BBC) 579 2013+ NO BLOCK HEATER	2.5" WIDE	-	TP-10133 18 x G4 HOLES	TP-10133LM 18 x TLED-G4A	TP-10133LMC 18 x TLED-G4CA	-	-	-
80" SLEEPERS UNDERBODY EXHAUST (123" BBC) 579 2013+ 1 BLOCK HEATER	2.5" WIDE	-	TP-10130 18 x G4 HOLES	TP-10130LM 18 x TLED-G4A	TP-10130LMC 18 x TLED-G4CA	-	-	-
80" SLEEPERS UNDERBODY EXHAUST (123" BBC) 579 2013+ 2 BLOCK HEATER	2.5" WIDE	TP-10180	TP-10131 18 x G4 HOLES	TP-10131LM 18 x TLED-G4A	TP-10131LMC 18 x TLED-G4CA	-	-	-

 WARNING: Cancer and Reproductive Harm - www.p65warnings.ca.gov

CAB, 80" SLEEPER & EXTENSION KITS

LONG HOOD MODELS - STAINLESS STEEL

	PANEL WIDTH	BLANK	G4 HOLES			3/4" HOLES		
80" SLEEPERS CAB EXHAUST (123" BBC) 579 ALL YEARS 1 BLOCK HEATER	3" WIDE	TP-10181	TP-10183 18 x G4 HOLES	TP-10183LM 18 x TLED-G4A	TP-10183LMC 18 x TLED-G4CA	-	-	-
80" SLEEPERS CAB EXHAUST (123" BBC) 579 ALL YEARS 2 BLOCK HEATER	3" WIDE	TP-10182	TP-10143 18 x G4 HOLES	TP-10143LM 18 x TLED-G4A	TP-10143LMC 18 x TLED-G4CA	-	-	-

CAB, 72" SLEEPER & EXTENSION KITS

LONG HOOD MODELS - STAINLESS STEEL

	PANEL WIDTH	BLANK	G4 HOLES			3/4" HOLES		
72" SLEEPERS UNDERBODY EXHAUST (123" BBC) 579 2013+ NO BLOCK HEATER	2.5" WIDE	-	TP-10115 16 x G4 HOLES	TP-10115LM 16 x TLED-G4A	TP-10115LMC 16 x TLED-G4CA	-	-	-
72" SLEEPERS UNDERBODY EXHAUST (123" BBC) 579 2013+ 1 BLOCK HEATER	2.5" WIDE	TP-10114	TP-10116 16 x G4 HOLES	TP-10116LM 16 x TLED-G4A	TP-10116LMC 16 x TLED-G4CA	-	-	-
72" SLEEPERS UNDERBODY EXHAUST (123" BBC) 579 2013+ 2 BLOCK HEATER	2.5" WIDE	-	TP-10140 16 x G4 HOLES	TP-10140LM 16 x TLED-G4A	TP-10140LMC 16 x TLED-G4CA	-	-	-
72" SLEEPERS CAB EXHAUST (123" BBC) 579 ALL YEARS NO BLOCK HEATER	3" WIDE	TP-10177	TP-10179 18 x G4 HOLES	TP-10179LM 18 x TLED-G4A	TP-10179LMC 18 x TLED-G4CA	-	-	-
72" SLEEPERS CAB EXHAUST (123" BBC) 579 ALL YEARS 1 BLOCK HEATER	3" WIDE	TP-10178	TP-10142 18 x G4 HOLES	TP-10142LM 18 x TLED-G4A	TP-10142LMC 18 x TLED-G4CA	-	-	-



 WARNING: Cancer and Reproductive Harm - www.p65warnings.ca.gov





PETERBILT 579

CAB, 44" SLEEPER & EXTENSION KITS LONG HOOD MODELS - STAINLESS STEEL

	PANEL WIDTH	BLANK	G4 HOLES			3/4" HOLES		
44" SLEEPERS UNDERBODY EXHAUST (123" BBC) 579 2013+ NO BLOCK HEATER	2.5" WIDE	TP-10170	TP-10173 14 x G4 HOLES	TP-10173LM 14 x TLED-G4A	TP-10173LMC 14 x TLED-G4CA	-	-	-
44" SLEEPERS UNDERBODY EXHAUST (123" BBC) 579 2013+ 1 BLOCK HEATER	2.5" WIDE	TP-10171	TP-10174 14 x G4 HOLES	TP-10174LM 14 x TLED-G4A	TP-10174LMC 14 x TLED-G4CA	-	-	-
44" SLEEPERS UNDERBODY EXHAUST (123" BBC) 579 2013+ 2 BLOCK HEATER	2.5" WIDE	TP-10172	TP-10175 14 x G4 HOLES	TP-10175LM 14 x TLED-G4A	TP-10175LMC 14 x TLED-G4CA	-	-	-







CAB, 80" SLEEPER & EXTENSION KITS SHORT HOOD MODELS - STAINLESS STEEL

	PANEL WIDTH	BLANK	G4 HOLES			3/4" HOLES		
80" SLEEPERS UNDERBODY EXHAUST (117" BBC) 579 2013+ 1 BLOCK HEATER	2.5" WIDE	TP-10157	TP-10144 18 x G4 HOLES	TP-10144LM 18 x TLED-G4A	TP-10144LMC 18 x TLED-G4CA	-	-	-
80" SLEEPERS UNDERBODY EXHAUST (117" BBC) 579 2013+ 2 BLOCK HEATER	2.5" WIDE	TP-10158	TP-10159 18 x G4 HOLES	TP-10159LM 18 x TLED-G4A	TP-10159LMC 18 x TLED-G4CA	-	-	-
80" SLEEPERS CAB EXHAUST (117" BBC) 579 2013+ 1 BLOCK HEATER	3" WIDE	TP-10154	TP-10156 18 x G4 HOLES	TP-10156LM 18 x TLED-G4A	TP-10156LMC 18 x TLED-G4CA	-	-	-
80" SLEEPERS CAB EXHAUST (117" BBC) 579 2013+ 2 BLOCK HEATER	3" WIDE	TP-10153	TP-10155 18 x G4 HOLES	TP-10155LM 18 x TLED-G4A	TP-10155LMC 18 x TLED-G4CA	-	-	-

 WARNING: Cancer and Reproductive Harm - www.p65warnings.ca.gov

CAB, 72" SLEEPER & EXTENSION KITS

SHORT HOOD MODELS - STAINLESS STEEL

	PANEL WIDTH	BLANK	G4 HOLES			3/4" HOLES		
72" SLEEPERS UNDERBODY EXHAUST (117" BBC) 579 2013+ NO BLOCK HEATER	2.5" WIDE	TP-10146	TP-10150 18 x G4 HOLES	TP-10150LM 1186 x TLED-G4A	TP-10150LMC 18 x TLED-G4CA	-	-	-
72" SLEEPERS UNDERBODY EXHAUST (117" BBC) 579 2013+ 1 BLOCK HEATER	2.5" WIDE	TP-10148	TP-10152 18 x G4 HOLES	TP-10152LM 18 x G4 HOLES	TP-10152LMC 18 x G4 HOLES	-	-	-
72" SLEEPERS CAB EXHAUST (117" BBC) 579 2013+ NO BLOCK HEATER	3" WIDE	TP-10145	TP-10149 18 x G4 HOLES	TP-10149LM 18 x TLED-G4A	TP-10149LMC 18 x TLED-G4CA	-	-	-
72" SLEEPERS CAB EXHAUST (117" BBC) 579 2013+ 1 BLOCK HEATER	3" WIDE	TP-10147	TP-10151 18 x G4 HOLES	TP-10151LM 18 x TLED-G4A	TP-10151LMC 18 x TLED-G4CA	-	-	-

CAN'T FIND WHAT YOU'RE LOOKING FOR?
WITH OVER 2000 MORE PRODUCTS ON OUR WEBSITE, YOU'D BE SURE TO FIND WHAT YOU WANT!



VISIT OUR WEBSITE
TRUXACCESSORIES.COM

PETERBILT TRIMS

DOOR WINDOW SHADES WITH MIRROR CUTOUTS | WITHOUT MIRROR CUTOUTS



STAINLESS STEEL
TP-1401 With Mirror Cutout



STAINLESS STEEL
TP-1402 Without Mirror Cutout



STAINLESS STEEL
TP-1431 Without Mirror Cutout

TECHNICAL SPECIFICATIONS

MODELS WITH 1.9M CAB

TP-1401: All Cab Mounted Models except NGP Models (2005-2012)

TP-1402: All Models (2005+)

TP-1431: All Cab Mounted Models except NGP Models (2012+)

WHAT'S INCLUDED	Hardware & 3M Tape (Double Sided)
SOLD	As a Pair
WARRANTY	1 Year

TP-1401 & TP-1431 will not fit NGP Cab Models (387,587,579 & 567).

WIPER ARM COVERS - ALL YEARS



STAINLESS STEEL
TP-0130

TECHNICAL SPECIFICATIONS

PETERBILT MODELS

ALL MODELS (All Years)

WHAT'S INCLUDED	3M Tape (Double Sided)
SOLD	As a Pair
WARRANTY	1 Year

Install with supplied 3M Tape.

WINDSHIELD CONTOUR & CENTER TRIM - 1987+



STAINLESS STEEL
TP-0196

TECHNICAL SPECIFICATIONS

PETERBILT MODELS

**389, 388, 379, 378, 377, 367,
340, 335 & 330** (1987+)

WHAT'S INCLUDED	3M Tape (Double Sided)
SOLD	As a Kit (3 Pieces)
WARRANTY	1 Year

Install with supplied 3M Tape.

REAR SLEEPER WINDOW TRIM - ALL YEARS



STAINLESS STEEL
TP-1407

TECHNICAL SPECIFICATIONS

MODELS WITH 37" WINDOW

ALL MODELS (All Years)

WHAT'S INCLUDED	Hardware & 3M Tape (Double Sided)
SOLD	Individually
WARRANTY	1 Year

Install with supplied 3M Tape & Screws.

WARNING: Cancer and Reproductive Harm - www.p65warnings.ca.gov

BATTERY/TOOLBOX PANELS - 1993+



STAINLESS STEEL
TP-1602

TECHNICAL SPECIFICATIONS

PETERBILT MODELS

ALL MODELS EXCEPT 579 (1993+)

DIMENSIONS	30.44" x 12.75"
WHAT'S INCLUDED	Hardware
SOLD	As a Pair
WARRANTY	1 Year

Install with supplied Hardware.

5" WINDOW CHOP TOPS DOOR MOUNTED MIRRORS - ALL YEARS



STAINLESS STEEL
TP-1436

TECHNICAL SPECIFICATIONS

MODELS WITH DOOR MOUNTED MIRRORS

389, 388, 386, 379, 378 (All Years)

WHAT'S INCLUDED	Hardware
SOLD	As a Pair
WARRANTY	1 Year

Install with supplied Hardware.



STAINLESS STEEL
TP-1439 With Flange

5" WINDOW CHOP TOPS CAB MOUNTED MIRRORS - ALL YEARS



STAINLESS STEEL
TP-1437



STAINLESS STEEL
TP-1438 With Flange

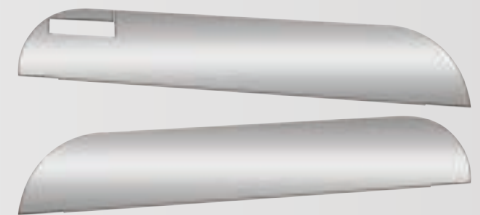

STAINLESS STEEL
TP-1446 Convex Mirror Cutout

TECHNICAL SPECIFICATIONS

MODELS WITH CAB MOUNTED MIRRORS

TP-1437/TP-1438: 389, 388, 379 & 378 (All Years)

TP-1446: 389, 388, 386, 384, 379, 378, 367, 365, 357, 348, 340, 337, 335 & 330 (All Years)

WHAT'S INCLUDED	Hardware
SOLD	As a Pair
WARRANTY	1 Year

Install with supplied Hardware.

WARNING: Cancer and Reproductive Harm - www.p65warnings.ca.gov

PETERBILT TRIMS

BATTERY & TOOL BOX COVERS



14 GAUGE 304 STAINLESS STEEL
TP-1662 Battery & Tool Box Cover Set
TP-1662B Battery Box Cover Only
TP-1662T Tool Box Cover Only

TECHNICAL SPECIFICATIONS

PETERBILT MODELS

389 (Current Year Gliders) **388** (Pre-2010)
379 (1988-2007)

WHAT'S INCLUDED	Hardware
SOLD	TP-1662: As a Kit TP-1662B/T: Individually
WARRANTY	1 Year

Install with supplied Hardware.

PASSENGER DOOR WINDOW TRIM - 2005+



STAINLESS STEEL
TP-1413

TECHNICAL SPECIFICATIONS

PETERBILT MODELS

ALL MODELS (2005+)

WHAT'S INCLUDED	Silicone
SOLD	Individually
WARRANTY	1 Year

Install with supplied Silicone.

AIR LINE BOX | COVER - ALL YEARS

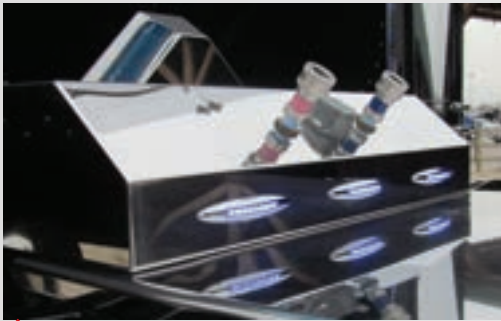

STAINLESS STEEL
TP-1645 Box with 3 x FG4 Holes
TP-1651 Back Panel

TECHNICAL SPECIFICATIONS

PETERBILT MODELS

ALL MODELS (All Years)

WHAT'S INCLUDED	Hardware
SOLD	Individually
WARRANTY	1 Year

Install with supplied Hardware.

379/389 LOUVERED HALF MOON STRAIGHT GRILLE BARS - ALL YEARS



STAINLESS STEEL
TP-1143 33.5" Vertical Bar



STAINLESS STEEL
TP-1144 39" Horizontal Bar

TECHNICAL SPECIFICATIONS

PETERBILT MODELS

379 & 389 (All Years)

DIMENSIONS	TP-1143: 33.5" Long TP-1144: 39" Long
SOLD	Individually
WARRANTY	1 Year

Install with supplied Hardware.

WARNING: Cancer and Reproductive Harm - www.p65warnings.ca.gov

379 LONG HOOD LOUVERED STRAIGHT GRILLE BARS - 1987+



STAINLESS STEEL
TP-1104 34" Straight (7 Bars)

TECHNICAL SPECIFICATIONS

LONG HOOD MODELS

379 (1987+)

WHAT'S INCLUDED	Hardware
SOLD	As a Kit (7 Grille Bars)
WARRANTY	1 Year

Install with supplied Hardware.

379 SHORT HOOD LOUVERED STRAIGHT GRILLE BARS - ALL YEARS



STAINLESS STEEL
TP-1002 Straight (15 Bars)

TECHNICAL SPECIFICATIONS

SHORT HOOD MODELS

379 (All Years)

WHAT'S INCLUDED	Hardware
SOLD	As a Kit (15 Grille Bars)
WARRANTY	1 Year

Install with supplied Hardware.

379/359 LONG HOOD LOUVERED STRAIGHT GRILLE BARS - ALL YEARS



STAINLESS STEEL
TP-1001 Straight (16 Bars)

TECHNICAL SPECIFICATIONS

LONG HOOD MODELS

379 & 359 (All Years)

WHAT'S INCLUDED	Hardware
SOLD	As a Kit (16 Grille Bars)
WARRANTY	1 Year

Install with supplied Hardware.

379/378/359 LONG HOOD LOUVERED ANGLED GRILLE BARS - ALL YEARS



STAINLESS STEEL
TP-1102 Angled (15 Bars)

TECHNICAL SPECIFICATIONS

LONG HOOD MODELS

379, 378 & 359 (All Years)

WHAT'S INCLUDED	Hardware
SOLD	As a Kit (15 Grille Bars)
WARRANTY	1 Year

Install with supplied Hardware.

PETERBILT TRIMS

379 FRONT FENDER TRIMS ALL YEARS



STAINLESS STEEL
TP-1219

TECHNICAL SPECIFICATIONS

PETERBILT MODELS

379 (All Years)

WHAT'S INCLUDED	3M Tape (Double Sided)
SOLD	As a Pair
WARRANTY	1 Year

Install with supplied Hardware.

379 FENDER GUARDS ALL YEARS



STAINLESS STEEL
TP-1201

TECHNICAL SPECIFICATIONS

PETERBILT MODELS

379 (All Years)

WHAT'S INCLUDED	Hardware
SOLD	As a Pair
WARRANTY	1 Year

Install with supplied Hardware.

379/378 FENDER TRIMS ALL YEARS



STAINLESS STEEL
TFT-PET379 Outer Trim

TECHNICAL SPECIFICATIONS

LONG/SHORT HOOD MODELS

379 & 378 (All Years)

WHAT'S INCLUDED	3M Tape (Double Sided)
SOLD	As a Pair
WARRANTY	1 Year

TFT-PET379F is 49.6" Long. Install with supplied 3M Tape.



STAINLESS STEEL
TFT-PET379F Inner Trim

386 AIR INTAKE COVER WITH LOGO - 2007+



STAINLESS STEEL
TP-1119 Logo Cutout

TECHNICAL SPECIFICATIONS

PETERBILT MODEL

386 (2007+)

WHAT'S INCLUDED	Hardware & 3M Tape (Double Sided)
SOLD	Individually
WARRANTY	1 Year

Install with supplied 3M Tape & Hardware.

WARNING: Cancer and Reproductive Harm - www.p65warnings.ca.gov

389 FENDER GUARDS - SINGLE HEADLIGHT



STAINLESS STEEL
TP-1228

TECHNICAL SPECIFICATIONS

PETERBILT MODEL	
389 (2018+)	

WHAT'S INCLUDED	Hardware
SOLD	As a Kit
WARRANTY	1 Year

Install with supplied Hardware.

389/388 HOOD LATCH GUARDS - 2007+



STAINLESS STEEL
TP-1112

TECHNICAL SPECIFICATIONS

PETERBILT MODEL	
389, 388 (2007+)	

SOLD	As a Kit
WARRANTY	1 Year

Mounted using existing hardware.

389 HOOD EMBLEM STRIPE ACCENTS - 2007+



STAINLESS STEEL
TP-1113

TECHNICAL SPECIFICATIONS

LONG HOOD MODEL	
389 131" BBC (2007+)	

WHAT'S INCLUDED	3M Tape (Double Side)
SOLD	As a Kit
WARRANTY	1 Year

Mounted using the existing Emblem Mounting Studs & supplied 3M Tape.

389/388 FENDER GUARD SINGLE HEADLIGHT - 2007+



STAINLESS STEEL
TP-1210 Blank

TECHNICAL SPECIFICATIONS

PETERBILT MODELS	
389 & 388 (2007+)	

WHAT'S INCLUDED	Hardware
SOLD	As a Kit
WARRANTY	1 Year

Install with supplied 3M Tape & Hardware.

389/388 FENDER GUTTER TRIMS - 2007+



STAINLESS STEEL
TP-1211

TECHNICAL SPECIFICATIONS

PETERBILT MODELS	
389 & 388 (2007+)	

WHAT'S INCLUDED	Hardware & 3M Tape (Double Sided)
SOLD	As a Pair
WARRANTY	1 Year

Drilling is required. Install with supplied 3M Tape & Hardware.

PETERBILT TRIMS

389/388 FENDER TRIMS 2008+



STAINLESS STEEL
TFT-PET389

TECHNICAL SPECIFICATIONS

PETERBILT MODELS

389 & 388 (2008+)

WHAT'S INCLUDED	3M Tape (Double Sided)
SOLD	As a Pair
WARRANTY	1 Year

Install with supplied 3M Tape.

389/388 BATTERY TOOLBOX PANELS - 2007+



STAINLESS STEEL
TP-1606

TECHNICAL SPECIFICATIONS

PETERBILT MODELS

389 & 388 (2007+)

WHAT'S INCLUDED	Hardware
SOLD	As a Pair
WARRANTY	1 Year

Install with supplied Hardware.

389/388 LICENSE/TAG SWING PLATES SINGLE / DOUBLE / TRIPLE - 2007+



STAINLESS STEEL
TP-1701 1 Plate



STAINLESS STEEL
TP-1702 2 Plates



STAINLESS STEEL
TP-1703 3 Plates

TECHNICAL SPECIFICATIONS

PETERBILT MODELS

389 & 388 (2007+)

GAUGE	18 Gauge
WHAT'S INCLUDED	Hardware & Bezels
SOLD	As a Kit
WARRANTY	1 Year

Install using existing bumper mounting bolts on bumper face. Does not require drilling.

 **WARNING: Cancer and Reproductive Harm - www.p65warnings.ca.gov**

579 FENDER TRIMS

LONG HOOD - ALL YEARS



STAINLESS STEEL
TFT-PET579

TECHNICAL SPECIFICATIONS

LONG HOOD MODELS

579 123" BBC (All Years)

WHAT'S INCLUDED	3M Tape (Double Sided)
SOLD	As a Kit (4 Pieces)
WARRANTY	1 Year

Install with supplied 3M Tape.

579 HEADLIGHT TRIMS

2013+



STAINLESS STEEL
TP-1218

TECHNICAL SPECIFICATIONS

PETERBILT MODEL

579 (2013+)

WHAT'S INCLUDED	Hardware & 3M Tape (Double Side)
SOLD	As a Pair
WARRANTY	1 Year

Install with supplied 3M Tape.

579 SIDE HOOD TRIMS

LONG HOOD - ALL YEARS



STAINLESS STEEL
TP-1129

TECHNICAL SPECIFICATIONS

LONG HOOD MODELS

579 123" BBC (All Years)

WHAT'S INCLUDED	3M Tape (Double Side)
SOLD	As a Pair
WARRANTY	1 Year

Install with supplied 3M Tape.

579 DOOR WINDOW TRIMS

ALL YEARS



STAINLESS STEEL
TP-1434

TECHNICAL SPECIFICATIONS

PETERBILT MODEL

579 (All Years)

WHAT'S INCLUDED	3M Tape (Double Side)
SOLD	As a Pair
WARRANTY	1 Year

Install with supplied 3M Tape.

PETERBILT TRIMS

579 STEP TRIMS LOWER BACK | UPPER BACK | FRONT

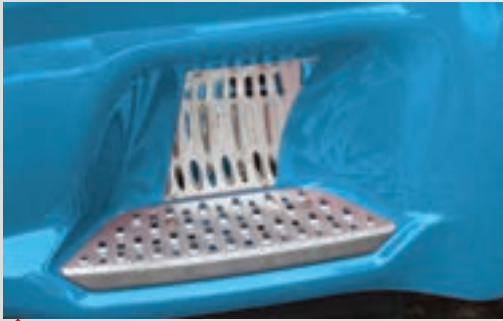

STAINLESS STEEL
TP-1643 Lower Back Step



STAINLESS STEEL
TP-1646 Upper Back Step



STAINLESS STEEL
TP-1648 Front Step

TECHNICAL SPECIFICATIONS

PETERBILT MODEL

TP-1643: 579 (All Years) **TP-1646:** 579 (2013+)
TP-1648: 579 (2013+)

WHAT'S INCLUDED	Hardware & 3M Tape (Double Sided)
SOLD	As a Pair
WARRANTY	1 Year

Install with supplied 3M Tape & Hardware.

579 AIR INTAKE GRILLE TRIMS - 2013+



STAINLESS STEEL
TP-1123

TECHNICAL SPECIFICATIONS

PETERBILT MODEL

579 (2013+)

WHAT'S INCLUDED	Hardware & 3M Tape (Double Side)
SOLD	As a Pair
WARRANTY	1 Year

Install with supplied 3M Tape & Hardware.

579/567 DOOR HANDLE TRIMS - ALL YEARS



STAINLESS STEEL
TP-1433

TECHNICAL SPECIFICATIONS

PETERBILT MODELS

579 & 567 (All Years)

WHAT'S INCLUDED	3M Tape (Double Side)
SOLD	As a Pair
WARRANTY	1 Year

Install with supplied 3M Tape & Hardware.

 **WARNING:** Cancer and Reproductive Harm - www.p65warnings.ca.gov

579/567 DOOR WINDOW TRIMS - ALL YEARS



▲
STAINLESS STEEL
TP-1445

TECHNICAL SPECIFICATIONS

PETERBILT MODELS

579 & 567 (All Years)

WHAT'S INCLUDED	3M Tape (Double Side)
SOLD	As a Pair
WARRANTY	1 Year

Install with supplied 3M Tape.

579/567 DOOR WINDOW SHADES - 2013+



▲
STAINLESS STEEL
TP-1440

TECHNICAL SPECIFICATIONS

MODELS WITH/WITHOUT PASSENGER MIRROR

579 & 567 (All Years)

WHAT'S INCLUDED	Hardware & 3M Tape (Double Side)
SOLD	As a Pair
WARRANTY	1 Year

Install with supplied 3M Tape & Hardware.

579/567 CAB DOOR CONTOUR TRIMS - ALL YEARS



▲
STAINLESS STEEL
TP-1444

TECHNICAL SPECIFICATIONS

PETERBILT MODELS

579 & 567 (All Years)

WHAT'S INCLUDED	3M Tape (Double Side)
SOLD	As a Pair
WARRANTY	1 Year

Install with supplied 3M Tape.

587 AIR INTAKE GRILLE TRIMS - 2011+

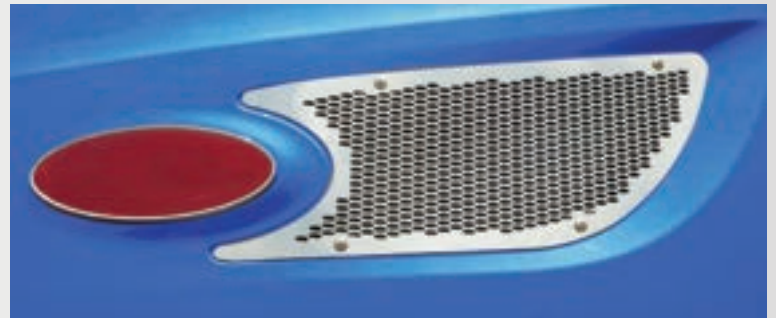

▲
STAINLESS STEEL
TP-1128

TECHNICAL SPECIFICATIONS

PETERBILT MODEL

587 (2011+)

WHAT'S INCLUDED	Hardware & 3M Tape (Double Sided)
SOLD	As a Pair
WARRANTY	1 Year

Install with supplied 3M Tape & Hardware.

KENWORTH SUN VISORS

11" CURVED GLASS SUN VISOR - 1998-2006



STAINLESS STEEL
TSUN-K4

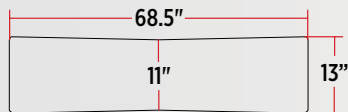

TECHNICAL SPECIFICATIONS

CURVED WINDSHIELD MODELS

W900B, W900L & T800 (1998-2006)

DIMENSIONS	Width: 68.5" Sides: 13" Drop: 11"
WHAT'S INCLUDED	3 x Sun Visor Brackets & Hardware
WARRANTY	1 Year

Trux's definition of a Curved Glass Windshield is that on both passenger & driver sides near the doors, the Windshield curves approximately three inches towards the back of the truck. Will fit a 1 Piece or 2 Piece Windshield. Will not replace Fiberglass Sun Visor. Visit our website at www.truxaccessories.com for Installation Instructions.

12" CURVED GLASS SUN VISOR - 2008+



STAINLESS STEEL
TSUN-K14 Blank
TSUN-K13 5 x OEM Holes

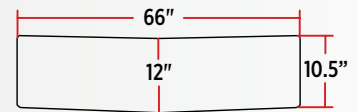

TECHNICAL SPECIFICATIONS

CURVED WINDSHIELD MODELS

T660, T800 & W900 (2008+)

DIMENSIONS	Width: 66" Sides: 10.5" Drop: 12"
WHAT'S INCLUDED	3 x Sun Visor Brackets & Hardware
WARRANTY	1 Year

TSUN-K13: OEM replacement for the composite lighted visor. Visit our website at www.truxaccessories.com for Installation Instructions.

13" BOLTESS BOWTIE CURVED GLASS SUN VISOR - 1995+



STAINLESS STEEL
TSUN-K6

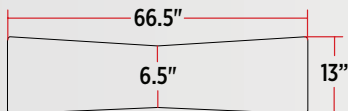

TECHNICAL SPECIFICATIONS

CURVED WINDSHIELD MODELS

KENWORTH AEROCAB MODELS (1995+)

DIMENSIONS	Width: 66.5" Sides: 13" Drop: 6.5"
WHAT'S INCLUDED	8 x Sun Visor Brackets & Hardware
WARRANTY	1 Year

Trux's definition of a Curved Glass Windshield is that on both passenger & driver sides near the doors, the Windshield curves approximately three inches towards the back of the truck. Designed to replace OEM Sun Visor. Visit our website at www.truxaccessories.com for Installation Instructions.

14" CURVED GLASS SUN VISOR - PRE-2007



STAINLESS STEEL
TSUN-K1 Blank
TSUN-K2 8 x 2" Holes

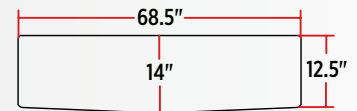

TECHNICAL SPECIFICATIONS

CURVED WINDSHIELD MODELS

T800, W900B & W900L (Pre-2007)

DIMENSIONS	Width: 68.5" Sides: 12.5" Drop: 14"
WHAT'S INCLUDED	5 x Sun Visor Brackets & Hardware
WARRANTY	1 Year

Trux's definition of a Curved Glass Windshield is that on both passenger & driver sides near the doors, the Windshield curves approximately three inches towards the back of the truck. Will fit a 1 Piece or 2 Piece Windshield. Will not replace Fiberglass Sun Visor. Visit our website at www.truxaccessories.com for Installation Instructions.

WARNING: Cancer and Reproductive Harm - www.p65warnings.ca.gov

14" CURVED GLASS STANDARD CAB SUN VISOR - 2007+



STAINLESS STEEL
TSUN-K5

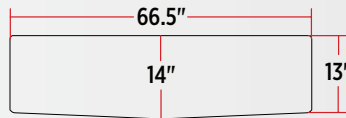

TECHNICAL SPECIFICATIONS

CURVED WINDSHIELD MODELS

W900B, W900L, T800, T660 & T600 (2007+)

DIMENSIONS	Width: 66.5" Sides: 13" Drop: 14"
WHAT'S INCLUDED	5 x Sun Visor Brackets & Hardware
WARRANTY	1 Year

Trux's definition of a Curved Glass Windshield is that on both passenger & driver sides near the doors, the Windshield curves approximately three inches towards the back of the truck. Will fit a 1 Piece or 2 Piece Windshield. Will not replace Fiberglass Sun Visor. Visit our website at www.truxaccessories.com for Installation Instructions.

11" FLAT GLASS SUN VISOR - 1988-2005



STAINLESS STEEL
TSUN-K12

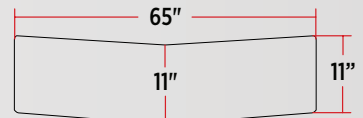

TECHNICAL SPECIFICATIONS

FLAT WINDSHIELD MODELS

T600, T800, W900B & W900L (1988-2005)

DIMENSIONS	Width: 65" Sides: 11" Drop: 11"
WHAT'S INCLUDED	3 x Sun Visor Brackets & Hardware
WARRANTY	1 Year

Trux's definition of Flat Glass Windshield is that on both passenger and driver sides near the doors, the Windshield is perfectly straight. Will fit a 1 Piece or 2 Piece Windshield. Will not replace Fiberglass Sun Visor. Visit our website at www.truxaccessories.com for Installation Instructions.

13" FLAT GLASS STANDARD CAB SUN VISOR - 2007+



STAINLESS STEEL
TSUN-K11

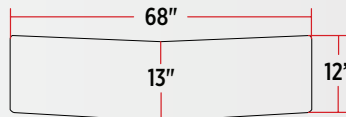

TECHNICAL SPECIFICATIONS

FLAT WINDSHIELD MODELS

ALL KENWORTH MODELS (2007+)

DIMENSIONS	Width: 68" Sides: 12" Drop: 13"
WHAT'S INCLUDED	5 x Sun Visor Brackets & Hardware
WARRANTY	1 Year

Replaces OEM 2 Piece Sun Visor. Visit our website at www.truxaccessories.com for Installation Instructions.

15" FLAT GLASS SUN VISOR - PRE-2007



STAINLESS STEEL
TSUN-K8

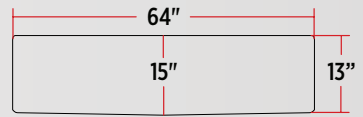

TECHNICAL SPECIFICATIONS

FLAT WINDSHIELD MODELS

T800, W900B & W900L (Pre-2007)

DIMENSIONS	Width: 64" Sides: 13" Drop: 15"
WHAT'S INCLUDED	3 x Sun Visor Brackets & Hardware
WARRANTY	1 Year

Trux's definition of Flat Glass Windshield is that on both passenger and driver sides near the doors, the Windshield is perfectly straight. Will fit a 1 Piece or 2 Piece Windshield. Will not replace Fiberglass Sun Visor. Visit our website at www.truxaccessories.com for Installation Instructions.

KENWORTH SUN VISORS

8.5" HIGH ROOF SUN VISOR - 2012+



STAINLESS STEEL
TSUN-K20

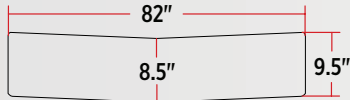

TECHNICAL SPECIFICATIONS

HIGH ROOF SLEEPER MODELS

T680 & T880 (2012+)

DIMENSIONS	Width: 82" Sides: 9.5" Drop: 8.5"
WHAT'S INCLUDED	4 x Sun Visor Brackets & Hardware
WARRANTY	1 Year

Visit our website at www.truxaccessories.com for Installation Instructions.

8.5" DAY CAB SUN VISOR - 2012+



OEM METAL
TSUN-K21

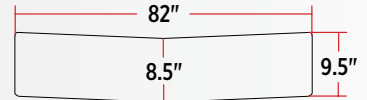

TECHNICAL SPECIFICATIONS

DAY CAB MODELS WITH OEM SUN VISOR

T680 & T880 (2012+)

DIMENSIONS	Width: 82" Sides: 9.5" Drop: 8.5"
WHAT'S INCLUDED	3 x Sun Visor Brackets & Hardware
WARRANTY	1 Year

For Models with OEM Metal Sun Visor. Visit our website at www.truxaccessories.com for Installation Instructions.

11.5" BOLTLESS DAY CAB SUN VISOR - 2013-2015



STAINLESS STEEL
TSUN-K23 Blank
TSUN-K45 18 x 3/4" Holes

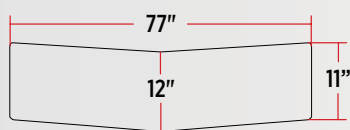

TECHNICAL SPECIFICATIONS

LOW ROOF DAY CAB MODELS

T680 & T880 (2013-2015)

DIMENSIONS	Width: 77" Sides: 11" Drop: 12"
WHAT'S INCLUDED	5 x Sun Visor Brackets & Hardware
WARRANTY	1 Year

Replaces the OEM Stainless Steel Visor. Fits 2016+ Models if installed with OEM Brackets. 2 Piece Sun Visor. Visit our website at www.truxaccessories.com for Installation Instructions.

11.5" DAY CAB SUN VISOR - 2012+



STAINLESS STEEL
TSUN-K22

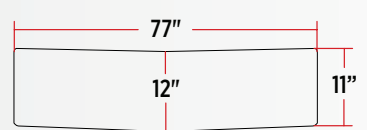

TECHNICAL SPECIFICATIONS

LOW ROOF DAY CAB MODELS

T680 & T880 (2012+)

DIMENSIONS	Width: 77" Sides: 11" Drop: 12"
WHAT'S INCLUDED	5 x Sun Visor Brackets & Hardware
WARRANTY	1 Year

For Models WITHOUT an existing OEM Visor. 2 Piece Sun Visor. Visit our website at www.truxaccessories.com for Installation Instructions.

WARNING: Cancer and Reproductive Harm - www.p65warnings.ca.gov

W900B BUG DEFLECTOR HOOD SHIELD - 1967+



STAINLESS STEEL
THOD-KW900B

TECHNICAL SPECIFICATIONS

KENWORTH MODEL

W900B (1967+)

DIMENSIONS	Width: 48"
WHAT'S INCLUDED	Hardware
WARRANTY	1 Year

Visit our website at www.truxaccessories.com for Installation Instructions.

W900L BUG DEFLECTOR HOOD SHIELD - 1989+



STAINLESS STEEL
THOD-KW900L

TECHNICAL SPECIFICATIONS

KENWORTH MODEL

W900L (1989+)

DIMENSIONS	Width: 43"
WHAT'S INCLUDED	Hardware
WARRANTY	1 Year

Visit our website at www.truxaccessories.com for Installation Instructions.

T680 BUG DEFLECTOR HOOD SHIELD - ALL YEARS



STAINLESS STEEL
THOD-KWT680

TECHNICAL SPECIFICATIONS

KENWORTH MODEL

T680 (All Years)

DIMENSIONS	Width: 56.63"
WHAT'S INCLUDED	Hardware
WARRANTY	1 Year

Drilling of mounting holes through fiberglass hood is required. Visit our website at www.truxaccessories.com for Installation Instructions.

T800 BUG DEFLECTOR HOOD SHIELD - 1987+



STAINLESS STEEL
THOD-KWT800

TECHNICAL SPECIFICATIONS

KENWORTH MODEL

T800 (1987+)

DIMENSIONS	Width: 48"
WHAT'S INCLUDED	Hardware
WARRANTY	1 Year

Visit our website at www.truxaccessories.com for Installation Instructions.

KENWORTH BUG DEFLECTORS

T660 BUG DEFLECTOR HOOD SHIELD - 2006-2017



STAINLESS STEEL
THOD-KWT660

TECHNICAL SPECIFICATIONS

KENWORTH MODEL

T660 (2006-2017)

DIMENSIONS	Width: 37.5"
WHAT'S INCLUDED	Hardware
WARRANTY	1 Year

Visit our website at www.truxaccessories.com for Installation Instructions.

T880 BUG DEFLECTOR HOOD SHIELD - 2012+



STAINLESS STEEL
THOD-KWT880

TECHNICAL SPECIFICATIONS

KENWORTH MODEL

T880 (2012+)

DIMENSIONS	Width: 54.6"
WHAT'S INCLUDED	Hardware
WARRANTY	1 Year

Visit our website at www.truxaccessories.com for Installation Instructions.

T600 BUG DEFLECTOR HOOD SHIELD - 1996-2006



STAINLESS STEEL
THOD-KWT600

TECHNICAL SPECIFICATIONS

KENWORTH MODEL

T600 (1996-2006)

DIMENSIONS	Width: 42"
WHAT'S INCLUDED	Hardware
WARRANTY	1 Year

Visit our website at www.truxaccessories.com for Installation Instructions.

T2000 BUG DEFLECTOR HOOD SHIELD - 1997-2010



STAINLESS STEEL
THOD-KWT2000

TECHNICAL SPECIFICATIONS

KENWORTH MODEL

T2000 (1997-2010)

DIMENSIONS	Width: 55.5"
WHAT'S INCLUDED	Hardware
WARRANTY	1 Year

Visit our website at www.truxaccessories.com for Installation Instructions.

 **WARNING: Cancer and Reproductive Harm - www.p65warnings.ca.gov**

T370/T270/T170 BUG DEFLECTOR
HOOD SHIELD - 2008+



STAINLESS STEEL
THOD-KW70

TECHNICAL SPECIFICATIONS

KENWORTH MODELS
T370, T270 & T170 (2008+)

DIMENSIONS	Width: 48.2"
WHAT'S INCLUDED	Hardware
WARRANTY	1 Year

Visit our website at www.truxaccessories.com for Installation Instructions.

T300 BUG DEFLECTOR
HOOD SHIELD - 2005-2007



STAINLESS STEEL
THOD-KWT300

TECHNICAL SPECIFICATIONS

KENWORTH MODEL
T300 (2005-2007)

DIMENSIONS	Width: 46.6"
WHAT'S INCLUDED	Hardware
WARRANTY	1 Year

Visit our website at www.truxaccessories.com for Installation Instructions.

CAN'T FIND WHAT YOU'RE LOOKING FOR?
WITH OVER 2000 MORE PRODUCTS ON OUR WEBSITE, YOU'D
BE SURE TO FIND WHAT YOU WANT!



VISIT OUR WEBSITE
TRUXACCESSORIES.COM

KENWORTH T680







- 430 Mirror Shine Stainless Steel
- LED Lighting
- 1 Year Warranty

- Hardware Included
- Sold as a Pre-Wired & Assembled Kit*

*Depending on Part Number

CAB PANELS STAINLESS STEEL

	PANEL WIDTH	BLANK	G4 HOLES			3/4" HOLES		
SINGLE EXHAUST T680 & T880 2013+ NO BLOCK HEATER	3.82" WIDE	TK-13100	TK-13101 4 x G4 HOLES	TK-13101LM 4 x TLED-G4A	TK-13101LMC 4 x TLED-G4CA	-	-	-
SINGLE EXHAUST T680 & T880 2013+ 1 BLOCK HEATER	3.52" WIDE	TK-13104	-	-	-	-	-	-
DUAL EXHAUST T680 & T880 ALL YEARS 1 BLOCK HEATER	5" WIDE	TK-13102	-	-	-	TK-13103 12 x 3/4" HOLES	TK-13103L 12 x TLED-B2A	TK-13103LC 12 x TLED-B2CA
DUAL EXHAUST T680 & T880 ALL YEARS 2 BLOCK HEATER	5" WIDE	TK-13105	TK-13106 4 x G4 HOLES	TK-13106LM 4 x TLED-G4A	TK-13106LMC 4 x TLED-G4CA	TK-13107 12 x 3/4" HOLES	TK-13107L 12 x TLED-B2A	TK-13107LC 12 x TLED-B2CA

NO Drilling is Required. Install with existing hardware.

Drilling is Required. Install with supplied Hardware.

 WARNING: Cancer and Reproductive Harm - www.p65warnings.ca.gov

TRANSITION PANELS STAINLESS STEEL

	PANEL WIDTH	BLANK	G4 HOLES			3/4" HOLES		
HIGH ROOF 76" SLEEPER T680 ALL YEARS	3.27" WIDE	-	TK-1682 2 x G4 HOLES	TK-1682LM 2 x TLED-G4A	TK-1682LMC 2 x TLED-G4CA	-	-	-

CAB, SLEEPER & EXTENSION KITS STAINLESS STEEL

	PANEL WIDTH	BLANK	G4 HOLES			3/4" HOLES		
HIGH ROOF 76" SLEEPER UNDERMOUNT EXHAUST WITH TRANSITION PANEL T680 2013+ NO BLOCK HEATER	2.5" WIDE	TK-1033	TK-1035 16 x G4 HOLES	TK-1035LM 16 x TLED-G4A	TK-1035LMC 16 x TLED-G4CA	TK-1074 40 x 3/4" HOLES	TK-1074L 40 x TLED-B2A	TK-1074LC 40 x TLED-B2CA
HIGH ROOF 76" SLEEPER UNDERMOUNT EXHAUST WITH TRANSITION PANEL T680 2013+ 1 BLOCK HEATER	2.5" WIDE	TK-1032	TK-1034 16 x G4 HOLES	TK-1034LM 16 x TLED-G4A	TK-1034LMC 16 x TLED-G4CA	TK-1086 40 x 3/4" HOLES	TK-1086L 40 x TLED-B2A	TK-1086LC 40 x TLED-B2CA

MID ROOF 76" SLEEPER UNDERMOUNT EXHAUST WITH TRANSITION PANEL T680 ALL YEARS NO BLOCK HEATER	2.5" WIDE	TK-1087	TK-1088 14 x G4 HOLES	TK-1088LM 14 x TLED-G4A	TK-1088LMC 14 x TLED-G4CA	TK-1089 38 x 3/4" HOLES	TK-1089L 38 x TLED-B2A	TK-1089LC 38 x TLED-B2CA
MID ROOF 76" SLEEPER UNDERMOUNT EXHAUST WITH TRANSITION PANEL T680 ALL YEARS 1 BLOCK HEATER	2.5" WIDE	TK-1090	TK-1091 14 x G4 HOLES	TK-1091LM 14 x TLED-G4A	TK-1091LMC 14 x TLED-G4CA	TK-1092 38 x 3/4" HOLES	TK-1092L 38 x TLED-B2A	TK-1092LC 38 x TLED-B2CA

MID ROOF 52" SLEEPER UNDERMOUNT EXHAUST T680 2014+ NO BLOCK HEATER	2.5" WIDE	TK-1055	TK-1057 10 x G4 HOLES	TK-1057LM 10 x TLED-G4A	TK-1057LMC 10 x TLED-G4CA	-	-	-
MID ROOF 52" SLEEPER UNDERMOUNT EXHAUST T680 2014+ 1 BLOCK HEATER	2.5" WIDE	TK-1056	TK-1058 10 x G4 HOLES	TK-1058LM 10 x TLED-G4A	TK-1058LMC 10 x TLED-G4CA	-	-	-

Drilling is Required. Install with supplied Hardware.

KENWORTH T660



- 430 Mirror Shine Stainless Steel
- LED Lighting
- 1 Year Warranty

- Hardware Included
- Sold as a Pre-Wired & Assembled Kit*

*Depending on Part Number

CAB, SLEEPER & EXTENSION KITS STAINLESS STEEL

	PANEL WIDTH	BLANK	INFINITY HOLES			3/4" HOLES		
72" SLEEPER WITH CHASSIS FAIRING T660 2013+ 1 BLOCK HEATER	3.25" WIDE	TK-1037	TK-1038 22 x INFINITY HOLES	TK-1038L 22 x TLED-INF2A	TK-1038LC 22 x TLED-INF2CA	TK-1093 30 x 3/4" HOLES	TK-1093L 30 x TLED-B2A	TK-1093LC 30 x TLED-B2CA

Install with supplied Hardware.



 WARNING: Cancer and Reproductive Harm - www.p65warnings.ca.gov



- 430 Mirror Shine Stainless Steel
- LED Lighting
- 1 Year Warranty

- Hardware Included
- Sold as a Pre-Wired & Assembled Kit*

*Depending on Part Number

FRONT AIR CLEANER LIGHT BARS STAINLESS STEEL

	PANEL SIZE	G2 HOLES			3/4" HOLES		
FRONT STANDARD AIR CLEANERS W900L 1982+	21.77" LONG 6" MOUNT	TK-1844 14 x G2 HOLES	TK-1844LM 14 x TLED-G2A	TK-1844LMC 14 x TLED-G2CA	TK-1848 12 x 3/4" HOLES	TK-1848L 12 x TLED-B2A	TK-1848LC 12 x TLED-B2CA
FRONT PREMIUM AIR CLEANERS W900 2010+	22.38" LONG 5.25" MOUNT	TK-1814 14 x G2 HOLES	TK-1814LM 14 x TLED-G2A	TK-1814LMC 14 x TLED-G2CA	TK-1852 16 x 3/4" HOLES	TK-1852L 16 x TLED-B2A	TK-1852LC 16 x TLED-B2CA

Attaches to the brackets between the Cab & Air Cleaner with existing hardware.

REAR AIR CLEANER LIGHT BARS STAINLESS STEEL

	PANEL SIZE	G2 HOLES			3/4" HOLES		
REAR 13/15" STANDARD AIR CLEANERS W900L 1982+	21.88" LONG 6.35" MOUNT	TK-1845 14 x G2 HOLES	TK-1845LM 14 x TLED-G2R	TK-1845LMC 14 x TLED-G2CR	-	-	-
REAR 13/15" STANDARD AIR CLEANERS KENWORTH MODELS ALL YEARS	19.75" LONG 4" MOUNT	-	-	-	TK-1858 12 x 3/4" HOLES	TK-1858L 12 x TLED-B2R	TK-1858LC 12 x TLED-B2CR
REAR PREMIUM AIR CLEANERS W900 2010+	22.38" LONG 5.25" MOUNT	TK-1815 14 x G2 HOLES	TK-1815LM 14 x TLED-G2R	TK-1815LMC 14 x TLED-G2CR	TK-1853 16 x 3/4" HOLES	TK-1853L 16 x TLED-B2R	TK-1853LC 16 x TLED-B2CR

Attaches to the brackets between the Cab & Air Cleaner with existing hardware.

KENWORTH W900







- 430 Mirror Shine Stainless Steel
- LED Lighting
- 1 Year Warranty

- Hardware Included
- Sold as a Pre-Wired & Assembled Kit*

*Depending on Part Number

LOWER HOOD PANELS STAINLESS STEEL

	PANEL WIDTH	BLANK	G4 HOLES			3/4" HOLES		
1989+ W900L	-	TK-1106	-	-	-	-	-	-
1989+ W900	-	TK-1127	-	-	-	-	-	-

Replaces OEM Panel behind the Front Fender.



 WARNING: Cancer and Reproductive Harm - www.p65warnings.ca.gov

CAB PANELS STAINLESS STEEL

	PANEL WIDTH	BLANK	G4 HOLES			3/4" HOLES		
UNDERBODY DPF AEROCAB W900L 2011+ NO BLOCK HEATER	6.57" WIDE DRIVER SIDE	TK-13108	TK-1387 6 x G4 HOLES	TK-1387LM 6 x TLED-G4A	TK-1387LMC 6 x TLED-G4CA	-	-	-

Passenger Side is 5.12" Wide & 51.67" Long. Will NOT fit Day Cab Models due to Exhaust. Install with supplied Hardware.

STEP DPF AEROCAB W900L 2011+ 1 BLOCK HEATER	6.57" WIDE DRIVER SIDE	TK-13109	TK-1377 6 x G4 HOLES	TK-1377LM 6 x TLED-G4A	TK-1377LMC 6 x TLED-G4CA	TK-13112 14 x 3/4" HOLES	TK-13112L 14 x TLED-B2A	TK-13112LC 14 x TLED-B2CA
STEP DPF WITH COURTESY LIGHT CUTOUT W900L 2011+ 1 BLOCK HEATER	6.57" WIDE DRIVER SIDE	TK-13110	TK-13111 6 x G4 HOLES	TK-13111LM 6 x TLED-G4A	TK-13111LMC 6 x TLED-G4CA	-	-	-

Passenger Side is 5.12" Wide & 51.67" Long. Will NOT fit Day Cab Models due to Exhaust. Install with supplied Hardware.

SLEEPER PANELS WITHOUT EXTENSION STAINLESS STEEL

	PANEL WIDTH	BLANK	G4 HOLES			3/4" HOLES		
72" SLEEPER SIDE MOUNT EXHAUST AEROCAB W900 EPA 2007+	3.5" WIDE	TK-1501	TK-1502 8 x G4 HOLES	TK-1502LM 8 x TLED-G4A	TK-1502LMC 8 x TLED-G4CA	TK-1578 14 x 3/4" HOLES	TK-1578L 18 x TLED-B2A	TK-1578LC 18 x TLED-B2CA

62" SLEEPER SIDE MOUNT EXHAUST AEROCAB W900 EPA 2007+	3.5" WIDE	TK-1513	TK-1514 6 x G4 HOLES	TK-1514LM 6 x TLED-G4A	TK-1514LMC 6 x TLED-G4CA	TK-1565 14 x 3/4" HOLES	TK-1565L 14 x TLED-B2A	TK-1565LC 14 x TLED-B2CA
--------------------------------------------------------------------------	--------------	----------------	--------------------------------	----------------------------------	------------------------------------	-----------------------------------	----------------------------------	------------------------------------

Install with supplied Hardware.

SLEEPER PANELS WITH EXTENSION STAINLESS STEEL

	PANEL WIDTH	BLANK	G4 HOLES			3/4" HOLES		
72" SLEEPER SIDE MOUNT EXHAUST AEROCAB W900L EPA 2007+	3.5" WIDE	TK-1503	TK-1504 10 x G4 HOLES	TK-1504LM 10 x TLED-G4A	TK-1504LMC 10 x TLED-G4CA	-	-	-
72" SLEEPER SIDE MOUNT EXHAUST AEROCAB W900 2007+	3.5" WIDE	-	-	-	-	TK-1566 24 x 3/4" HOLES	TK-1566L 24 x TLED-B2A	TK-1566LC 24 x TLED-B2CA

62" SLEEPER SIDE MOUNT EXHAUST AEROCAB W900 EPA 2007+	3.5" WIDE	TK-1515	TK-1579 8 x G4 HOLES	TK-1579LM 8 x TLED-G4A	TK-1579LMC 8 x TLED-G4CA	TK-1580 20 x 3/4" HOLES	TK-1580L 20 x TLED-B2A	TK-1580LC 20 x TLED-B2CA
--------------------------------------------------------------------------	--------------	----------------	--------------------------------	----------------------------------	------------------------------------	-----------------------------------	----------------------------------	------------------------------------

Install with supplied Hardware.

 **WARNING:** Cancer and Reproductive Harm - www.p65warnings.ca.gov

KENWORTH T800



- 430 Mirror Shine Stainless Steel
- LED Lighting
- 1 Year Warranty

- Hardware Included
- Sold as a Pre-Wired & Assembled Kit*

*Depending on Part Number

CAB PANELS STAINLESS STEEL

	PANEL WIDTH	BLANK	G4 HOLES			3/4" HOLES		
AEROCAB T800 1995-2010 NO BLOCK HEATER	3.25" WIDE	TK-1318	TK-1370 6 x G4 HOLES	TK-1370LM 6 x TLED-G4A	TK-1370LMC 6 x TLED-G4CA	-	-	-

Cab Panels are 40.56" Long. Install with supplied Hardware.

WITH STEP DPF MX ENGINE T800 2011+ 1 BLOCK HEATER	3.25" WIDE	TK-13114	TK-1368 6 x G4 HOLES	TK-1368LM 6 x TLED-G4A	TK-1368LMC 6 x TLED-G4CA	-	-	-
-------------------------------------------------------------------	------------	-----------------	--------------------------------	----------------------------------	------------------------------------	---	---	---

Install with supplied Hardware.



 WARNING: Cancer and Reproductive Harm - www.p65warnings.ca.gov

SLEEPER PANELS WITHOUT EXTENSION

STAINLESS STEEL

	PANEL WIDTH	BLANK	G4 HOLES			3/4" HOLES		
72" SLEEPER SIDE MOUNT EXHAUST T800 EPA 2007+	3.5" WIDE	TK-1501	TK-1502 8 x G4 HOLES	TK-1502LM 8 x TLED-G4A	TK-1502LMC 8 x TLED-G4CA	TK-1578 14 x 3/4" HOLES	TK-1578L 18 x TLED-B2A	TK-1578LC 18 x TLED-B2CA
62" SLEEPER SIDE MOUNT EXHAUST T800 EPA 2007+	3.5" WIDE	TK-1513	TK-1514 6 x G4 HOLES	TK-1514LM 6 x TLED-G4A	TK-1514LMC 6 x TLED-G4CA	TK-1565 14 x 3/4" HOLES	TK-1565L 14 x TLED-B2A	TK-1565LC 14 x TLED-B2CA

Install with supplied Hardware.

SLEEPER PANELS WITH EXTENSION

STAINLESS STEEL

	PANEL WIDTH	BLANK	G4 HOLES			3/4" HOLES		
72" SLEEPER SIDE MOUNT EXHAUST T800 EPA 2007+	3.5" WIDE	TK-1503	TK-1504 10 x G4 HOLES	TK-1504LM 10 x TLED-G4A	TK-1504LMC 10 x TLED-G4CA	-	-	-
72" SLEEPER SIDE MOUNT EXHAUST T800 2007+	3.5" WIDE	-	-	-	-	TK-1566 24 x 3/4" HOLES	TK-1566L 24 x TLED-B2A	TK-1566LC 24 x TLED-B2CA
62" SLEEPER SIDE MOUNT EXHAUST T800 EPA 2007+	3.5" WIDE	TK-1515	TK-1579 8 x G4 HOLES	TK-1579LM 8 x TLED-G4A	TK-1579LMC 8 x TLED-G4CA	TK-1580 20 x 3/4" HOLES	TK-1580L 20 x TLED-B2A	TK-1580LC 20 x TLED-B2CA

Install with supplied Hardware.



 WARNING: Cancer and Reproductive Harm - www.p65warnings.ca.gov

KENWORTH TRIMS

DOOR WINDOW SHADES ALL YEARS

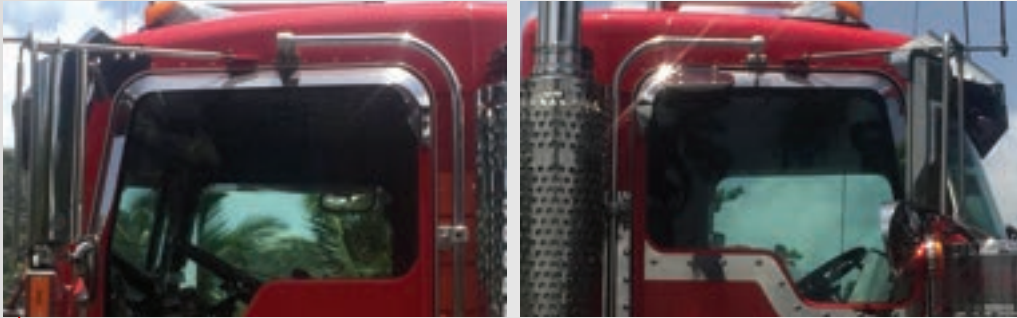

STAINLESS STEEL

TK-1401 Without Convex Mirror Cutout

TK-1402 With Convex Mirror Arm Cutout (Passenger)

TECHNICAL SPECIFICATIONS

MODELS WITH DAYLIGHT DOOR

ALL KENWORTH MODELS (All Years)

WHAT'S INCLUDED	Hardware & 3M Tape (Double Sided)
SOLD	As a Pair
WARRANTY	1 Year

HEADLIGHT VISORS ALL YEARS



STAINLESS STEEL

TK-1219 Double Headlights Only

TECHNICAL SPECIFICATIONS

KENWORTH MODELS

ALL MODELS (All Years)

SOLD	As a Pair
WARRANTY	1 Year

Install using existing hardware.

WINDOW CHOP TOPS ALL YEARS



STAINLESS STEEL

TK-1430 With Flange



STAINLESS STEEL

TK-1431 Without Flange

TECHNICAL SPECIFICATIONS

KENWORTH MODELS

ALL MODELS (All Years)

WHAT'S INCLUDED	3M Tape (Double Sided)
SOLD	As a Pair
WARRANTY	1 Year

Install using supplied 3M Tape.

 **WARNING:** Cancer and Reproductive Harm - www.p65warnings.ca.gov

FLAME HOOD EMBLEM ACCENT - ALL YEARS



STAINLESS STEEL
TK-1609

TECHNICAL SPECIFICATIONS

KENWORTH MODELS

ALL MODELS (All Years)

WHAT'S INCLUDED	3M Tape (Double Sided)
SOLD	As a Pair
WARRANTY	1 Year

Install using supplied 3M Tape.

W900/T800/T600/T300/C500 DAYLIGHT DOOR TRIMS - ALL YEARS



STAINLESS STEEL
TK-1407

TECHNICAL SPECIFICATIONS

MODELS WITH DAYLIGHT DOOR

W900, T800, T600, T300 & C500 (All Years)

WHAT'S INCLUDED	3M Tape (Double Sided)
SOLD	As a Pair
WARRANTY	1 Year

Will NOT fit T680, T880 or T2000 Models. Install using supplied 3M Tape.

T660/T470/T440/T370/T270/T170 AIR INTAKE LOGO TRIMS

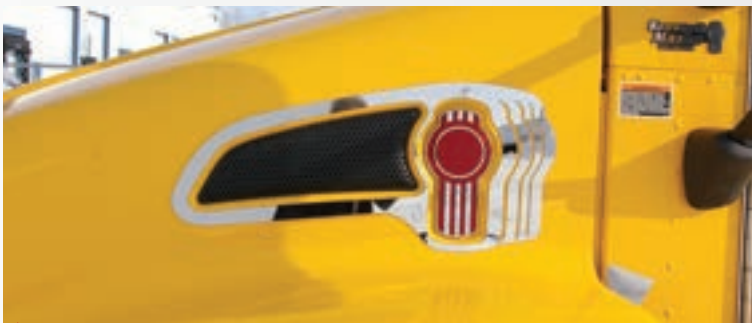

STAINLESS STEEL
TK-1121

TECHNICAL SPECIFICATIONS

KENWORTH MODELS

T660, T370, T270 & T170 (2005+)
T470, T440 (2010+)

WHAT'S INCLUDED	3M Tape (Double Sided)
SOLD	As a Pair
WARRANTY	1 Year

Install using supplied 3M Tape.

T660/T370 AIR INTAKE LOGO TRIMS - 2008+



STAINLESS STEEL
TK-1119

TECHNICAL SPECIFICATIONS

KENWORTH MODELS

T660 & T370 (2008+)

WHAT'S INCLUDED	3M Tape (Double Sided)
SOLD	As a Pair
WARRANTY	1 Year

Install using supplied 3M Tape.

KENWORTH TRIMS

BATTERY / TOOLBOX COVERS WITH STEPS



▲ STAINLESS STEEL
TK-1616 34" Wide



▲ STAINLESS STEEL
TK-1617 39.5" Wide



▲ STAINLESS STEEL
TK-1618 45" Wide

TECHNICAL SPECIFICATIONS

KENWORTH MODELS

TK-1616 (1987-2004) **TK-1617** (2005-2011)
TK-1618 (2005-2007)

WHAT'S INCLUDED	Hardware
SOLD	As a Kit
WARRANTY	1 Year

Replaces OEM Aluminium Covers. Install using supplied Hardware.



45" STEP HANGERS PRE-2005

BATTERY / TOOLBOX COVERS PRE-2005



▲ STAINLESS STEEL
TK-1631 For 45" Covers



▲ STAINLESS STEEL
TK-1630 39.5" Wide



▲ STAINLESS STEEL
TK-1634 45" Wide

TECHNICAL SPECIFICATIONS

KENWORTH MODELS

ALL MODELS (Pre-2005)

GAUGE	11 Gauge
WHAT'S INCLUDED	3M Tape (Double Sided)
SOLD	As a Pair
WARRANTY	1 Year

Install using supplied 3M Tape.

TECHNICAL SPECIFICATIONS

KENWORTH MODELS

ALL MODELS (Pre-2005)

WHAT'S INCLUDED	Hardware
SOLD	As a Pair
WARRANTY	1 Year

Install using supplied Hardware.

▲ WARNING: Cancer and Reproductive Harm - www.p65warnings.ca.gov

T680 FENDER TRIMS FOR MODEL WITH FAIRINGS - 2013+



STAINLESS STEEL
TFT-KWT680

TECHNICAL SPECIFICATIONS

MODEL WITH FAIRINGS

T680 (2013+)

WHAT'S INCLUDED	3M Tape (Double Sided)
SOLD	As a Kit (4 Pieces)
WARRANTY	1 Year

Install using supplied 3M Tape.

T680 FENDER TRIMS FOR MODEL WITHOUT FAIRINGS - 2013+



STAINLESS STEEL
TFT-KWT680N

TECHNICAL SPECIFICATIONS

MODEL WITHOUT FAIRINGS

T680 (2013+)

WHAT'S INCLUDED	3M Tape (Double Sided)
SOLD	As a Kit (4 Pieces)
WARRANTY	1 Year

Install using supplied 3M Tape.

T680 SIDE HOOD TRIMS LONG HOOD - ALL YEARS



STAINLESS STEEL
TK-1133

TECHNICAL SPECIFICATIONS

LONG HOOD MODEL

T680 (All Years)

WHAT'S INCLUDED	3M Tape (Double Sided)
SOLD	As a Kit (4 Pieces)
WARRANTY	1 Year

Install using supplied 3M Tape.

T680 CENTER HOOD TRIMS SHORT HOOD | LONG HOOD



STAINLESS STEEL
TK-1143 Long Hood SFA
TK-1144 Short Hood SBA

TECHNICAL SPECIFICATIONS

KENWORTH MODELS

TK-1143 T680 Long Hood Set Forward Axle (2015+)
TK-1144 T680 Short Hood Set Back Axle (2012+)

WHAT'S INCLUDED	3M Tape (Double Sided)
SOLD	Individually
WARRANTY	1 Year

Install using supplied 3M Tape.

KENWORTH TRIMS

T680 HEADLIGHT TRIMS - 2013+



STAINLESS STEEL
TK-1226

TECHNICAL SPECIFICATIONS

KENWORTH MODEL

T680 (2013+)

WHAT'S INCLUDED	Hardware & 3M Tape (Double Sided)
SOLD	As a Pair
WARRANTY	1 Year

Drilling of fender is required. Install using supplied Hardware & 3M Tape.

T680 UPPER SLEEPER WINDOW TRIMS - 2016+



STAINLESS STEEL
TK-1451 "T680" Cutout

TECHNICAL SPECIFICATIONS

HIGH ROOF MODELS

T680 (2016+)

WHAT'S INCLUDED	Hardware & 3M Tape (Double Sided)
SOLD	As a Pair
WARRANTY	1 Year

Install using supplied Hardware & 3M Tape.

T680 SLEEPER WINDOW TRIMS - 2013+



STAINLESS STEEL
TK-1651

TECHNICAL SPECIFICATIONS

KENWORTH MODEL

T680 (2013+)

WHAT'S INCLUDED	Hardware & 3M Tape (Double Sided)
SOLD	As a Pair
WARRANTY	1 Year

Install using supplied Hardware & 3M Tape.

T680 FRONT LOWER STEP KICK PLATES - PRE-2017

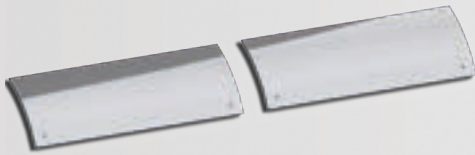

STAINLESS STEEL
TK-1670

TECHNICAL SPECIFICATIONS

LONG HOOD MODEL

T680 (Pre-2017)

WHAT'S INCLUDED	Hardware
SOLD	As a Pair
WARRANTY	1 Year

Install using supplied Hardware.

T680 FRONT LOWER STEP KICK PLATES - PRE-2017



STAINLESS STEEL
TK-1671

TECHNICAL SPECIFICATIONS

SHORT HOOD MODEL

T680 (Pre-2017)

WHAT'S INCLUDED	Hardware
SOLD	As a Pair
WARRANTY	1 Year

Install using supplied Hardware.

T680 FRONT UPPER STEP KICK PLATES - ALL YEARS



STAINLESS STEEL
TK-1672

TECHNICAL SPECIFICATIONS

KENWORTH MODEL

T680 (All Years)

WHAT'S INCLUDED	Hardware & 3M Tape (Double Sided)
SOLD	As a Pair
WARRANTY	1 Year

Install using supplied Hardware & 3M Tape.

WARNING: Cancer and Reproductive Harm - www.p65warnings.ca.gov

T680 DOUBLE LICENSE PLATE HOLDER - 2013+

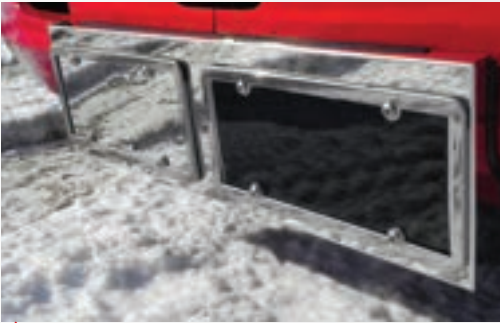

STAINLESS STEEL
TK-1712

TECHNICAL SPECIFICATIONS

SHORT HOOD MODEL

T680 (2013+)

WHAT'S INCLUDED	Hardware & Brackets
SOLD	Individually
WARRANTY	1 Year

Install using supplied Hardware & brackets.

T680/T880 DOOR WINDOW SHADES - 2012+



STAINLESS STEEL
TK-1438

TECHNICAL SPECIFICATIONS

LONG HOOD MODELS

T680 & T880 (2012+)

WHAT'S INCLUDED	Hardware & 3M Tape (Double Sided)
SOLD	As a Pair
WARRANTY	1 Year

Install using supplied Hardware & 3M Tape.

T680/T880 DOOR WINDOW SHADES - ALL YEARS



STAINLESS STEEL
TP-1440

TECHNICAL SPECIFICATIONS

KENWORTH MODELS

T680 & T880 (All Years)

WHAT'S INCLUDED	Hardware & 3M Tape (Double Sided)
SOLD	As a Pair
WARRANTY	1 Year

Designed for models with or without passenger side mirror. Install using supplied Hardware & 3M Tape.

T680/T880 DOOR HANDLE TRIMS - 2013+



STAINLESS STEEL
TK-1427

TECHNICAL SPECIFICATIONS

KENWORTH MODELS

T680 & T880 (2013+)

WHAT'S INCLUDED	Hardware & 3M Tape (Double Sided)
SOLD	As a Pair
WARRANTY	1 Year

Install using supplied Hardware & 3M Tape.

T680 DEF TANK INNER/OUTER TRIM - ALL YEARS



STAINLESS STEEL
TK-1680 Inner Trim
TK-1681 Outer Trim

TECHNICAL SPECIFICATIONS

SHORT HOOD MODELS

T680 (All Years)

WHAT'S INCLUDED	3M Tape (Double Sided)
SOLD	Individually
WARRANTY	1 Year

Install using supplied 3M Tape.

T680/T880 FENDER LIGHT TRIMS - 2013+



STAINLESS STEEL
TK-1428

TECHNICAL SPECIFICATIONS

KENWORTH MODELS

T680 & T880 (2013+)

WHAT'S INCLUDED	3M Tape (Double Sided)
SOLD	As a Pair
WARRANTY	1 Year

Install using supplied 3M Tape.

KENWORTH TRIMS

T660 UPPER PANEL KICK PLATES

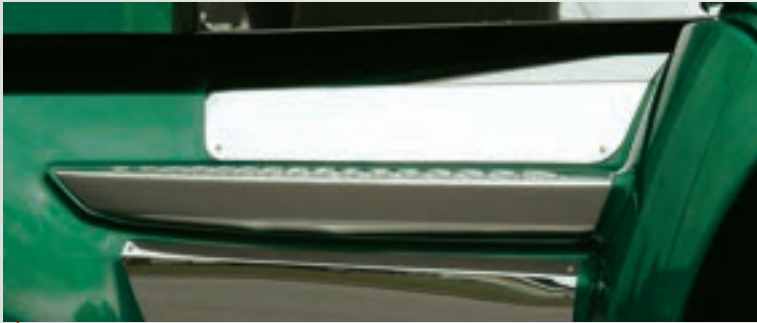

STAINLESS STEEL
TK-1602 Pre-2010
TK-1649 2011+

TECHNICAL SPECIFICATIONS

KENWORTH MODELS

TK-1602: T660 (Pre-2010) **TK-1649:** T660 (2011+)

WHAT'S INCLUDED	Hardware
SOLD	As a Pair
WARRANTY	1 Year

Install using supplied Hardware.

T660 LOWER PANEL FRONT KICK PLATES - 2007+

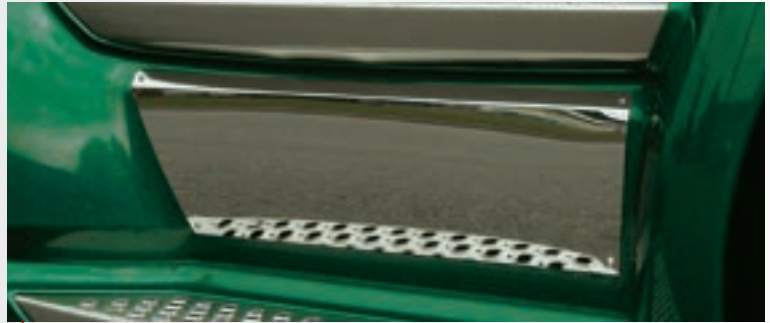

STAINLESS STEEL
TK-1603

TECHNICAL SPECIFICATIONS

KENWORTH MODEL

T660 (2007+)

WHAT'S INCLUDED	Hardware
SOLD	As a Pair
WARRANTY	1 Year

Install using supplied Hardware.

T680/T660/T700 UPPER PANEL BACK STEP TRIMS - 2007-2016



STAINLESS STEEL
TK-1620

TECHNICAL SPECIFICATIONS

KENWORTH MODELS

T680, T660 & T700 (2007-2016)

WHAT'S INCLUDED	Hardware & 3M Tape (Double Sided)
SOLD	As a Pair
WARRANTY	1 Year

Install using supplied Hardware & 3M Tape.

T680/T660/T700 LOWER PANEL PANEL BACK STEP TRIMS - 2007-2016



STAINLESS STEEL
TK-1621

TECHNICAL SPECIFICATIONS

KENWORTH MODELS

T680, T660 & T700 (2007-2016)

WHAT'S INCLUDED	Hardware & 3M Tape (Double Sided)
SOLD	As a Pair
WARRANTY	1 Year

Install using supplied Hardware & 3M Tape.

 **WARNING:** Cancer and Reproductive Harm - www.p65warnings.ca.gov

T660 FRONT FENDER HEADLIGHT TRIMS - 2006-2017



STAINLESS STEEL
TK-1211

TECHNICAL SPECIFICATIONS

KENWORTH MODEL

T660 (2006-2017)

WHAT'S INCLUDED	3M Tape (Double Sided)
SOLD	As a Pair
WARRANTY	1 Year

Install using supplied 3M Tape.

T660 FENDER TRIMS 2006-2017



STAINLESS STEEL
TFT-KWT660

TECHNICAL SPECIFICATIONS

KENWORTH MODEL

T660 (2006-2017)

WHAT'S INCLUDED	3M Tape (Double Sided)
SOLD	As a Kit
WARRANTY	1 Year

Install using supplied 3M Tape.

T660 LICENSE PLATE HOLDER - ALL YEARS



STAINLESS STEEL
TK-1704 Holds 2 Plates

TECHNICAL SPECIFICATIONS

KENWORTH MODEL

T660 (All Years)

WHAT'S INCLUDED	Hardware, Brackets & License Plate Bezels
SOLD	Individually
WARRANTY	1 Year

Install using supplied Hardware.

T660/W900L/B UPPER SLEEPER FORWARD FACING WINDOW TRIMS - ALL YEARS



STAINLESS STEEL
TK-1436

TECHNICAL SPECIFICATIONS

AEROCAB AERODYNE SLEEPER MODELS

T660, W900L & W900B (All Years)

WHAT'S INCLUDED	3M Tape (Double Sided)
SOLD	As a Pair
WARRANTY	1 Year

Install using supplied 3M Tape.

KENWORTH TRIMS

W900L LOUVERED STRAIGHT GRILLE BARS - ALL YEARS



STAINLESS STEEL
TK-1002 16 Straight Bars

TECHNICAL SPECIFICATIONS

KENWORTH MODEL

W900L (All Years)

WHAT'S INCLUDED	Hardware
SOLD	As a Kit (16 Bars)
WARRANTY	1 Year

Not Suitable for W900B Models. Install using supplied Hardware.

W900L LOUVERED ANGLED GRILLE BARS - ALL YEARS

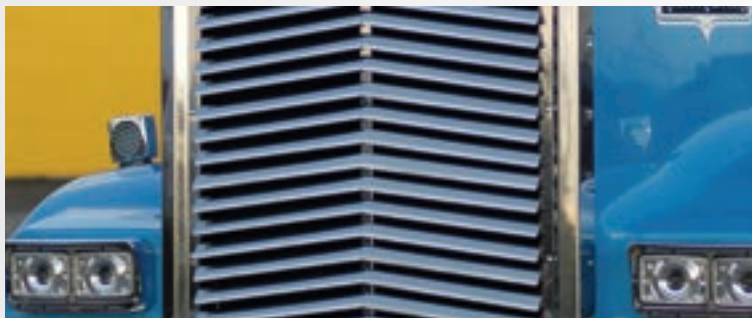

STAINLESS STEEL
TK-1003 16 Angled Bars

TECHNICAL SPECIFICATIONS

KENWORTH MODEL

W900L (All Years)

WHAT'S INCLUDED	Hardware
SOLD	As a Kit (16 Bars)
WARRANTY	1 Year

Not Suitable for W900B Models. Install using supplied Hardware.

W900B/L SIDE GRILLE DEFLECTORS - 1967+



STAINLESS STEEL
TK-1105

TECHNICAL SPECIFICATIONS

KENWORTH MODELS

W900L & W900B (1967+)

SOLD	As a Pair
WARRANTY	1 Year

Install to the side of the Grille with OEM Hardware.

W900L HOOD STRIP - PRE-2008



STAINLESS STEEL
TK-1111

TECHNICAL SPECIFICATIONS

KENWORTH MODEL

W900L (Pre-2008)

WHAT'S INCLUDED	Hardware & 3M Tape (Double Sided)
SOLD	Individually
WARRANTY	1 Year

Will NOT fit W900L Metton Hood Models. Install using supplied Hardware & 3M Tape.

W900 SWING LICENSE PLATE - ALL YEARS



STAINLESS STEEL
TK-1702 Holds 2 Plates

TECHNICAL SPECIFICATIONS

TEXAS STYLE BUMPER MODEL

W900B (All Years)

WHAT'S INCLUDED	Hardware & License Plate Bezels
SOLD	Individually
WARRANTY	1 Year

No drilling is required, Install onto existing Bumper Mounting Bolt Pattern. Install using supplied Hardware.

WARNING: Cancer and Reproductive Harm - www.p65warnings.ca.gov

W900B/L FENDER HEADLIGHT GUARDS



STAINLESS STEEL
TK-1203 W900L Models
TK-1204 W900B Aerocab Models

TECHNICAL SPECIFICATIONS

KENWORTH MODELS
TK-1203: W900L (1989+)
TK-1204: W900B Aerocab Curved Glass (1989-2009)

WHAT'S INCLUDED	Hardware
SOLD	As a Pair
WARRANTY	1 Year

W900B/L HEADLIGHT SURROUND FENDER GUARDS



STAINLESS STEEL
TK-1201 W900L Models



STAINLESS STEEL
TK-1202 W900B Models

TECHNICAL SPECIFICATIONS

KENWORTH MODELS
TK-1201: W900L (All Years)
TK-1202: W900B (1989-2009)

WHAT'S INCLUDED	Hardware
SOLD	As a Pair
WARRANTY	1 Year

Drilling is required. Install using supplied Hardware.

W900L AIR INTAKE SHROUDS - 2008+



STAINLESS STEEL
TK-1110

TECHNICAL SPECIFICATIONS

MODEL WITH METTON HOOD
W900L (2008+)

WHAT'S INCLUDED	Hardware
SOLD	As a Pair
WARRANTY	1 Year

Drilling into the Hood is required. Install using supplied Hardware.

W900L FRONT FENDER MUD FLAP BRACKETS



STAINLESS STEEL
TK-1901 Reinforcement Bracket

TECHNICAL SPECIFICATIONS

KENWORTH MODEL
W900L (All Years)

SOLD	As a Pair
WARRANTY	1 Year

Install using existing hardware.

KENWORTH TRIMS

W900L HOOD/BATTERY BOX FILLER PANELS - 1997-2010



STAINLESS STEEL
TK-1114



STAINLESS STEEL
TK-1113 8 x Slotted Holes

TECHNICAL SPECIFICATIONS

KENWORTH MODEL

W900L (1997-2010)

WHAT'S INCLUDED	Hardware, Brackets & *OEM Plug (*TK-1113 Only)
SOLD	As a Pair
WARRANTY	1 Year

Replacement for the OEM Hood/Battery Box Filler Panel. Install using supplied Hardware & Brackets.

W900/T800/T440 VIEW DOOR WINDOW TRIM

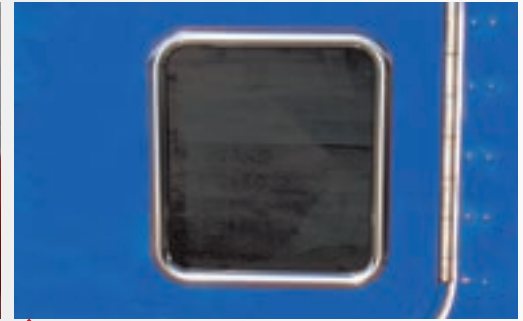

STAINLESS STEEL
TK-1409 Passenger Side

TECHNICAL SPECIFICATIONS

KENWORTH MODELS

W900, T800 & T440 (All Years)

WHAT'S INCLUDED	Silicone
SOLD	Individually
WARRANTY	1 Year

Install using supplied Silicone.

W900/T800 AIR INTAKE SHROUDS - 1982+



STAINLESS STEEL
TK-1107

TECHNICAL SPECIFICATIONS

KENWORTH MODELS

W900 & T800 (1982+)

WHAT'S INCLUDED	Hardware
SOLD	As a Pair
WARRANTY	1 Year

Drilling into the Hood is required. Install using supplied Hardware.

W900B/L/T800 FUEL TANK SKIRT FAIRINGS - 2013+



STAINLESS STEEL
TK-1419

TECHNICAL SPECIFICATIONS

KENWORTH MODELS

W900B, W900L & T800 (2013+)

DIMENSIONS	73" Long
SOLD	As a Pair
WARRANTY	1 Year

Install using existing Hardware.

WARNING: Cancer and Reproductive Harm - www.p65warnings.ca.gov

T800 SIDE GRILLE DEFLECTOR - ALL YEARS



STAINLESS STEEL
TK-1115

TECHNICAL SPECIFICATIONS

KENWORTH MODELS	
T800 (All Years)	

SOLD	Individually
WARRANTY	1 Year

Install using existing hardware.

T800 GRILLE SURROUND KIT - 1995+



STAINLESS STEEL
TK-1140 11 Straight Bars

TECHNICAL SPECIFICATIONS

KENWORTH MODELS	
T800 (1995+)	

SOLD	As a Kit (11 Bars)
WARRANTY	1 Year

Install using existing Hardware.

T800 HEADLIGHT SURROUND FENDER GUARDS

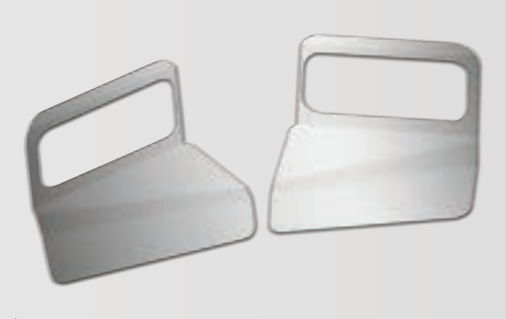

STAINLESS STEEL
TK-1224

TECHNICAL SPECIFICATIONS

FLAT GLASS STANDARD CAB MODELS	
T800 (All Years)	

WHAT'S INCLUDED	Hardware
SOLD	As a Pair
WARRANTY	1 Year

Drilling is required. Install with supplied Hardware.

T800 UNDER HEADLIGHT FENDER GUARDS



STAINLESS STEEL
TK-1225

TECHNICAL SPECIFICATIONS

STANDARD CAB MODELS	
T800 (1987-1995)	

WHAT'S INCLUDED	Hardware
SOLD	As a Pair
WARRANTY	1 Year

Drilling is required. Install using supplied Hardware.

T800 FENDER GUARDS STANDARD | AEROCAB CURVED GLASS



STAINLESS STEEL
TK-1205 Standard

TECHNICAL SPECIFICATIONS

KENWORTH MODELS	
TK-1205: T800 (Pre-2008)	
TK-1206: T800 Aerocab Curved Glass (2007+)	

WHAT'S INCLUDED	Hardware
SOLD	As a Pair
WARRANTY	1 Year

Drilling is required. Install using supplied Hardware.



STAINLESS STEEL
TK-1206 Aerocab Curved Glass

KENWORTH TRIMS

T800 AIR INTAKE SHROUDS AEROCAB HOOD | FIBERGLASS HOOD | METTON HOOD



STAINLESS STEEL
TK-1208 Aerocab Hood

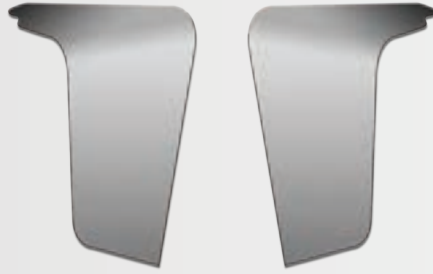

STAINLESS STEEL
TK-1209 Fiberglass Hood



STAINLESS STEEL
TK-1210 Metton Hood

TECHNICAL SPECIFICATIONS

SPLIT FENDER MODELS

TK-1208: T800 Aerocab Hood (Pre-2008)

TK-1209: T800 Fiberglass Hood (Pre-2008)

TK-1210: T800 Metton Hood (2008+)

WHAT'S INCLUDED	Hardware
SOLD	As a Pair
WARRANTY	1 Year

Install using the supplied Hardware. Drilling is required. NOT for wide hood models.

T800/T600 AIR INTAKE COVERS - ALL YEARS



STAINLESS STEEL
TK-1600 Driver Side
TK-1601 Passenger Side

TECHNICAL SPECIFICATIONS

STANDARD CAB MODELS

T800 & T600 (All Years)

WHAT'S INCLUDED	Hardware
SOLD	Individually
WARRANTY	1 Year

Drilling is required. Install using supplied hardware.

T600 HEADLIGHT FENDER GUARDS - ALL YEARS



STAINLESS STEEL
TK-1214

TECHNICAL SPECIFICATIONS

KENWORTH MODEL

T600 (All Years)

WHAT'S INCLUDED	Hardware
SOLD	As a Pair
WARRANTY	1 Year

Drilling is required. Install using supplied hardware.

T600 GRILLE BEZEL - ALL YEARS



STAINLESS STEEL
TK-0108

TECHNICAL SPECIFICATIONS

KENWORTH MODEL

T600 (All Years)

WHAT'S INCLUDED	Hardware
SOLD	Individually
WARRANTY	1 Year

Drilling & Bolting is required. Install using supplied hardware.

WARNING: Cancer and Reproductive Harm - www.p65warnings.ca.gov

T600 DOOR KICK PLATES - ALL YEARS



STAINLESS STEEL
TK-1406 Block Heater Hole

TECHNICAL SPECIFICATIONS

KENWORTH MODEL

T600 (All Years)

SOLD	As a Pair
WARRANTY	1 Year

Driver Side Block Heater Hole. Install using existing factory mounting holes.

T880 AIR INTAKE GRILLE TRIMS - 2013+



STAINLESS STEEL
TK-1141

TECHNICAL SPECIFICATIONS

KENWORTH MODEL

T880 (2013+)

WHAT'S INCLUDED	Hardware Kit
SOLD	As a Kit
WARRANTY	1 Year

Drilling of mounting holes through hood is required. Install using supplied Hardware.

T880 SIDE GRILLE DEFLECTORS - 2012+



STAINLESS STEEL
TK-1134

TECHNICAL SPECIFICATIONS

KENWORTH MODEL

T880 (2012+)

SOLD	As a Pair
WARRANTY	1 Year

Install using existing hardware.

T880 FRONT FENDER GUARDS HEADLIGHT GUARDS | SIDE GUARDS - 2012+



STAINLESS STEEL
TK-1229 Front Headlight Guards

TECHNICAL SPECIFICATIONS

KENWORTH MODEL

T880 (2012+)

WHAT'S INCLUDED	Hardware
SOLD	As a Pair
WARRANTY	1 Year

Install using supplied 3M Tape.



STAINLESS STEEL
TK-1232 Front Side Guards

T880 FRONT LIGHT TRIMS - 2012+



STAINLESS STEEL
TK-1228

TECHNICAL SPECIFICATIONS

KENWORTH MODEL

T880 (2012+)

WHAT'S INCLUDED	3M Tape (Double Side)
SOLD	As a Pair
WARRANTY	1 Year

Install using supplied 3M Tape.

FREIGHTLINER SUN VISORS

18" CASCADIA SUN VISOR - 2008-2013



STAINLESS STEEL
TSUN-F70 Blank
TSUN-F71 10 x 3/4" Holes



TECHNICAL SPECIFICATIONS

FREIGHTLINER MODEL

CASCADIA (2008-2013)

DIMENSIONS	Width: 84" Sides: 18" Drop: 18"
WHAT'S INCLUDED	4 x Sun Visor Brackets & All Hardware
WARRANTY	1 Year

Visit our website at www.truxaccessories.com for Installation Instructions. Drilling may be required.

16" DAYCAB SUN VISOR CASCADIA- 2008-2014



STAINLESS STEEL
TSUN-F26 Blank
TSUN-F37 22 x 3/4" Holes

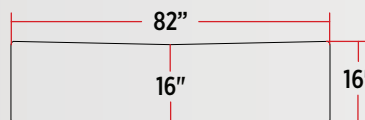

TECHNICAL SPECIFICATIONS

DAY CAB MODELS

CASCADIA (2008-2014)

DIMENSIONS	Width: 82" Sides: 16" Drop: 16"
WHAT'S INCLUDED	5 x Sun Visor Brackets, OEM Light Holes & All Hardware
WARRANTY	1 Year

TSUN-F26 & TSUN-F37 are designed with OEM light holes. For installation instructions visit our website.

14" DAYCAB SUN VISOR - 2001+



STAINLESS STEEL
TSUN-F24

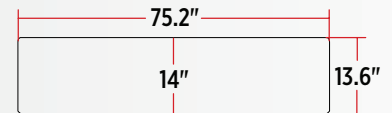

TECHNICAL SPECIFICATIONS

DAYCAB MODELS

CENTURY CLASS, COLUMBIA & CORONADO (2001+)

DIMENSIONS	Width: 75.2" Sides: 13.6" Drop: 14"
WHAT'S INCLUDED	3 x Sun Visor Brackets & All Hardware
WARRANTY	1 Year

Visit our website at www.truxaccessories.com for Installation Instructions. Drilling may be required.

16" RAISED & MID ROOF SUN VISOR - CASCADIA



STAINLESS STEEL
TSUN-F25 2008-2013
TSUN-F32 2014+

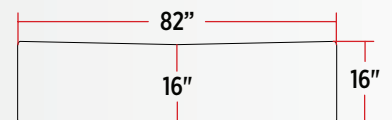

TECHNICAL SPECIFICATIONS

NON DAY CAB MODELS

TSUN-F25: CASCADIA (2008-2013) **TSUN-F32:** CASCADIA (2014+)

DIMENSIONS	Width: 82" Sides: 16" Drop: 16"
WHAT'S INCLUDED	5 x Sun Visor Brackets, OEM Light Holes & All Hardware
WARRANTY	1 Year

TSUN-F25 & TSUN-F32 are designed with OEM light holes and will not fit Daycab models. For installation instructions visit our website.

WARNING: Cancer and Reproductive Harm - www.p65warnings.ca.gov

16" RAISED & MID ROOF SUN VISOR



▲
STAINLESS STEEL
TSUN-F21 Blank

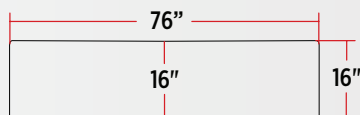

TECHNICAL SPECIFICATIONS

FREIGHTLINER MODELS

CORONADO (2001+)
CENTURY CLASS & COLUMBIA (Pre- 2005)

DIMENSIONS	Width: 76" Sides: 16" Drop: 16"
WHAT'S INCLUDED	3 x Sun Visor Brackets & All Hardware
WARRANTY	1 Year

Remove original factory brackets and install using TRUX brackets. For installation instructions visit our website.

16" RAISED & MID ROOF SUN VISOR - 2005+



▲
STAINLESS STEEL
TSUN-F17 Blank
TSUN-F19 5 x Slotted Holes

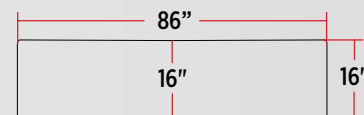

TECHNICAL SPECIFICATIONS

FREIGHTLINER MODELS

CENTURY CLASS & COLUMBIA (2005+)

DIMENSIONS	Width: 86" Sides: 16" Drop: 16"
WHAT'S INCLUDED	3 x Sun Visor Brackets & All Hardware
WARRANTY	1 Year

Remove original factory brackets and install using TRUX brackets. For installation instructions visit our website.

16" RAISED ROOF SUN VISOR - 1991+



▲
STAINLESS STEEL
TSUN-F6

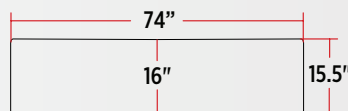

TECHNICAL SPECIFICATIONS

FREIGHTLINER MODELS

CLASSIC, CLASSIC XL, FLD112 & FLD120 (1991+)

DIMENSIONS	Width: 74" Sides: 15.5" Drop: 16"
WHAT'S INCLUDED	5 x Sun Visor Brackets & All Hardware
WARRANTY	1 Year

Remove original factory brackets and install using TRUX Brackets. For installation instructions visit our website.

16" RAISED ROOF SUN VISOR - 1991+



▲
STAINLESS STEEL
TSUN-F8 6 x Slotted Holes

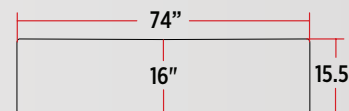

TECHNICAL SPECIFICATIONS

FREIGHTLINER MODELS

CLASSIC, CLASSIC XL, FLD120 & FLD112 (1991+)

DIMENSIONS	Width: 74" Sides: 15.5" Drop: 16"
WHAT'S INCLUDED	5 x Sun Visor Brackets & All Hardware
WARRANTY	1 Year

Remove original factory brackets and install using TRUX brackets. For installation instructions visit our website.

FREIGHTLINER SUN VISORS

15" OEM METAL FLAT TOP SUN VISOR - 1991+



▲
STAINLESS STEEL
TSUN-F1

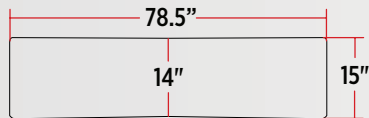

TECHNICAL SPECIFICATIONS

MODELS WITH CAB MOUNTED MIRRORS

CLASSIC, CLASSIC XL, FLD120 & FLD112 (1991+)

DIMENSIONS	Width: 78.5" Sides: 15" Drop: 14"
WHAT'S INCLUDED	5 x Sun Visor Brackets & All Hardware
WARRANTY	1 Year

Remove original factory brackets and install using TRUX brackets. For installation instructions visit our website.

15" OEM METAL FLAT TOP SUN VISOR - 1991+



▲
STAINLESS STEEL
TSUN-F2

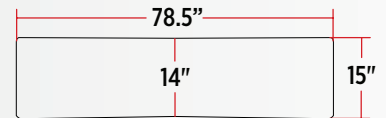

TECHNICAL SPECIFICATIONS

MODELS WITH DOOR MOUNTED MIRRORS

CLASSIC, CLASSIC XL, FLD112 & FLD120 (1991+)

DIMENSIONS	Width: 78.5" Sides: 15" Drop: 14"
WHAT'S INCLUDED	5 x Sun Visor Brackets & All Hardware
WARRANTY	1 Year

Remove original factory brackets and install using TRUX brackets. For installation instructions visit our website.

15" OEM FIBERGLASS FLAT TOP SUN VISOR - 1991+



▲
STAINLESS STEEL
TSUN-F3

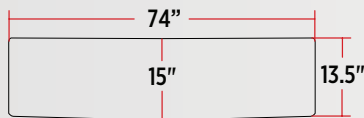

TECHNICAL SPECIFICATIONS

MODELS WITH CAB MOUNTED MIRRORS

CLASSIC, CLASSIC XL, FLD120 & FLD112 (1991+)

DIMENSIONS	Width: 74" Sides: 13.5" Drop: 15"
WHAT'S INCLUDED	5 x Sun Visor Brackets & All Hardware
WARRANTY	1 Year

Remove original factory brackets and install using TRUX brackets. For installation instructions visit our website.

15" OEM FIBERGLASS FLAT TOP SUN VISOR - 1991+



▲
STAINLESS STEEL
TSUN-F4

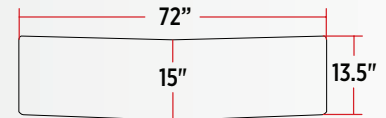

TECHNICAL SPECIFICATIONS

MODELS WITH DOOR MOUNTED MIRRORS

CLASSIC, CLASSIC XL, FLD120 & FLD112 (1991+)

DIMENSIONS	Width: 72" Sides: 13.5" Drop: 15"
WHAT'S INCLUDED	5 x Sun Visor Brackets & All Hardware
WARRANTY	1 Year

Remove original factory brackets and install using TRUX brackets. For installation instructions visit our website.

▲ **WARNING: Cancer and Reproductive Harm - www.p65warnings.ca.gov**

12.25" FLAT TOP SUN VISOR - 2003-2006



STAINLESS STEEL
TSUN-F27

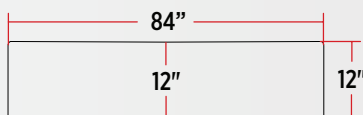

TECHNICAL SPECIFICATIONS

FREIGHTLINER MODELS

BUSINESS CLASS M2-106 & M2-112 (2003-2006)

DIMENSIONS	Width: 84" Sides: 12" Drop: 12"
WHAT'S INCLUDED	4 x Sun Visor Brackets & All Hardware
WARRANTY	1 Year

Remove original factory brackets and install using TRUX brackets. For installation instructions visit our website.

13.5" FLAT TOP SUN VISOR



STAINLESS STEEL
TSUN-F28

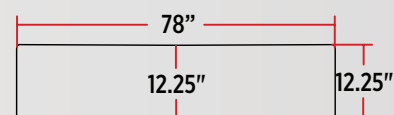

TECHNICAL SPECIFICATIONS

FREIGHTLINER MODELS

BUSINESS CLASS M2-106 & M2-112 Regular Cab (2006+)
BUSINESS CLASS 108SD-114SD (2012+)

DIMENSIONS	Width: 78" Sides: 12.25" Drop: 12.25"
WHAT'S INCLUDED	5 x Sun Visor Brackets & All Hardware
WARRANTY	1 Year

Remove original factory brackets and install using TRUX brackets. For installation instructions visit our website.

CAN'T FIND WHAT YOU'RE LOOKING FOR?
WITH OVER 2000 MORE PRODUCTS ON OUR WEBSITE, YOU'D
BE SURE TO FIND WHAT YOU WANT!



VISIT OUR WEBSITE
TRUXACCESSORIES.COM

FREIGHTLINER BUG DEFLECTORS

CASCADIA BUG DEFLECTOR HOOD SHIELD



STAINLESS STEEL
THOD-FLCAS 2008-2017
THOD-FLCAS2 2018+

TECHNICAL SPECIFICATIONS

FREIGHTLINER MODEL

THOD-FLCAS: CASCADIA (2008-2017)
THOD-FLCAS2: CASCADIA (2018+)

DIMENSIONS	Width: 60"
WHAT'S INCLUDED	Hardware
WARRANTY	1 Year

Drilling of mounting holes through the hood is required.

COLUMBIA BUG DEFLECTOR HOOD SHIELD - 2001+



STAINLESS STEEL
THOD-FLCOL

TECHNICAL SPECIFICATIONS

FREIGHTLINER MODEL

COLUMBIA (2001+)

DIMENSIONS	Width: 52"
WHAT'S INCLUDED	Hardware
WARRANTY	1 Year

Drilling of mounting holes through the hood is required.

CENTURY BUG DEFLECTOR HOOD SHIELD - 1996+



STAINLESS STEEL
THOD-FLCC

TECHNICAL SPECIFICATIONS

FREIGHTLINER MODELS

CENTURY CLASS (1996+)

DIMENSIONS	Width: 59"
WHAT'S INCLUDED	Hardware
WARRANTY	1 Year

Drilling of mounting holes through the hood is required.

CENTURY BUG DEFLECTOR HOOD SHIELD - 2005+



STAINLESS STEEL
THOD-FLCC2

TECHNICAL SPECIFICATIONS

FREIGHTLINER MODEL

CENTURY CLASS (2005+)

DIMENSIONS	Width: 49.3"
WHAT'S INCLUDED	Hardware
WARRANTY	1 Year

Designed with a built in grab handle for hood tilting. Drilling of mounting holes through the Fiberglass hood is required.

WARNING: Cancer and Reproductive Harm - www.p65warnings.ca.gov

CORONADO BUG DEFLECTOR HOOD SHIELD - 2003-2010



STAINLESS STEEL
THOD-FLCOR

TECHNICAL SPECIFICATIONS

FREIGHTLINER MODEL

CORONADO (2003-2010)

DIMENSIONS	Width: 56"
WHAT'S INCLUDED	All Hardware
WARRANTY	1 Year

Drilling of mounting holes through the hood is required.

CORONADO BUG DEFLECTOR HOOD SHIELD - 2010+

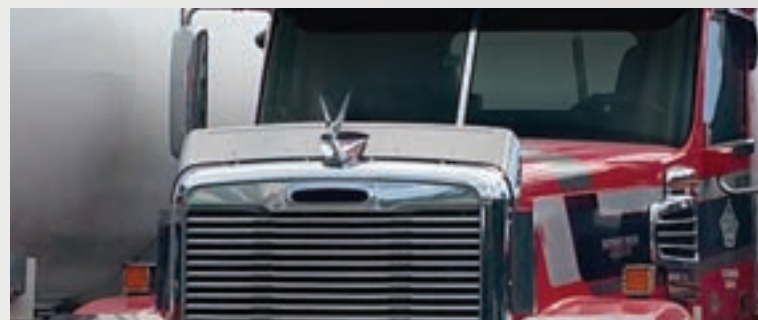

STAINLESS STEEL
THOD-FLCOR2

TECHNICAL SPECIFICATIONS

FREIGHTLINER MODEL

CORONADO (2010+)

DIMENSIONS	Width: 54.3"
WHAT'S INCLUDED	Hardware
WARRANTY	1 Year

Drilling of mounting holes through the hood is required.

CLASSIC BUG DEFLECTOR HOOD SHIELD - 1991+



STAINLESS STEEL
THOD-FLCL

TECHNICAL SPECIFICATIONS

FREIGHTLINER MODEL

CLASSIC (1991+)

DIMENSIONS	Width: 52"
WHAT'S INCLUDED	All Hardware
WARRANTY	1 Year

Drilling of mounting holes through the hood is required.

FLD120 BUG DEFLECTOR HOOD SHIELD - 1991+



STAINLESS STEEL
THOD-FLD120

TECHNICAL SPECIFICATIONS

FREIGHTLINER MODEL

FLD120 (1991+)

DIMENSIONS	Width: 46"
WHAT'S INCLUDED	All Hardware
WARRANTY	1 Year

Drilling of mounting holes through the hood is required.

FREIGHTLINER CASCADIA







- 430 Mirror Shine Stainless Steel
- LED Lighting
- 1 Year Warranty

- Hardware Included
- Sold as a Pre-Wired & Assembled Kit*

*Depending on Part Number

CAB, SLEEPER & EXTENSION KITS STAINLESS STEEL

	PANEL WIDTH	BLANK	G4 HOLES			3/4" HOLES		
72" SLEEPER STANDARD 2008 NO BLOCK HEATER	3" WIDE	TF-1019	TF-1020 16 x G4 HOLES	TF-1020LM 16 x TLED-G4A	TF-1020LMC 16 x TLED-G4CA	-	-	-
60" SLEEPER STANDARD 2008 NO BLOCK HEATER	3" WIDE	TF-1024	TF-1025 14 x G4 HOLES	TF-1025LM 14 x TLED-G4A	TF-1025LMC 14 x TLED-G4CA	-	-	-
72" SLEEPER EVOLUTION ALL YEARS 1 BLOCK HEATER	3" WIDE	TF-1017	TF-1018 16 x G4 HOLES	TF-1018LM 16 x TLED-G4A	TF-1018LMC 16 x TLED-G4CA	-	-	-
60" SLEEPER EVOLUTION ALL YEARS 1 BLOCK HEATER	3" WIDE	TF-1015	TF-1016 14 x G4 HOLES	TF-1016LM 14 x TLED-G4A	TF-1016LMC 14 x TLED-G4CA	-	-	-

Install using supplied Hardware.

 **WARNING:** Cancer and Reproductive Harm - www.p65warnings.ca.gov

5" WINDOW CHOP TOPS 2003-2010



STAINLESS STEEL
TF-1429



STAINLESS STEEL
TF-1430 Flange

TECHNICAL SPECIFICATIONS

FREIGHTLINER MODELS

COLUMBIA, CENTURY CLASS & CORONADO (2003-2010)

WHAT'S INCLUDED	3M Tape (Double Sided)
SOLD	As a Pair
WARRANTY	1 Year

Install using supplied 3M Tape.

WIPER ARM COVERS - 2000+



STAINLESS STEEL
TF-1010

TECHNICAL SPECIFICATIONS

FREIGHTLINER MODELS

**COLUMBIA, CENTURY CLASS
& CORONADO** (2000+)

WHAT'S INCLUDED	3M Tape (Double Sided)
SOLD	As a Pair
WARRANTY	1 Year

Install using supplied 3M Tape.

WIPER ARM COVERS 2004+



STAINLESS STEEL
TF-1011

TECHNICAL SPECIFICATIONS

FREIGHTLINER MODELS

CLASSIC & FLD-120 (2004+)

WHAT'S INCLUDED	3M Tape (Double Sided)
SOLD	As a Pair
WARRANTY	1 Year

Install using supplied 3M Tape.

DOOR WINDOW DEFLECTOR PRE-2010



STAINLESS STEEL
TF-1405

TECHNICAL SPECIFICATIONS

FREIGHTLINER MODELS

COLUMBIA, CENTURY CLASS & CORONADO (Pre-2010)

WHAT'S INCLUDED	3M Tape (Double Sided)
SOLD	As a Pair
WARRANTY	1 Year

Drilling of mounting holes through the hood is required. Install using supplied 3M Tape.

FREIGHTLINER TRIMS

CASCADIA FENDER SIDE TRIMS



STAINLESS STEEL
TFT-FLCAS 2008-2017
TFT-FLCAS3 2018+

TECHNICAL SPECIFICATIONS

FREIGHTLINER MODEL

TFT-FLCAS: CASCADIA (2008-2017)
TFT-FLCAS3: CASCADIA (2018+)

WHAT'S INCLUDED	3M Tape (Double Sided)
SOLD	As a Kit
WARRANTY	1 Year

Install using supplied 3M Tape.

CASCADIA HOOD LATCH INSERT - ALL YEARS



STAINLESS STEEL
TF-1109

TECHNICAL SPECIFICATIONS

FREIGHTLINER MODEL

CASCADIA (All Years)

WHAT'S INCLUDED	3M Tape (Double Sided)
SOLD	Individually
WARRANTY	1 Year

Install using supplied 3M Tape.

CASCADIA DOOR WINDOW SHADES



STAINLESS STEEL
TF-1410 2008-2017
TF-1454 2018+

TECHNICAL SPECIFICATIONS

CASCADIA MODELS

TF-1410: With Passenger Side Downward Mirror (2008-2017)
TF-1454: With/Without Passenger Side Downward Mirror (2018+)

WHAT'S INCLUDED	Hardware & 3M Tape (Double Sided)
SOLD	As a Pair
WARRANTY	1 Year

Install using supplied 3M Tape & Hardware.

CASCADIA LOWER WINDOW TRIMS - ALL YEARS



STAINLESS STEEL
TF-1409

TECHNICAL SPECIFICATIONS

FREIGHTLINER MODELS

CASCADIA (All Years)

WHAT'S INCLUDED	3M Tape (Double Sided)
SOLD	As a Pair
WARRANTY	1 Year

Install using supplied 3M Tape.

WARNING: Cancer and Reproductive Harm - www.p65warnings.ca.gov

CASCADIA 5" WINDOW CHOP TOPS



STAINLESS STEEL
TF-1437

CASCADIA SLEEPER DOOR TRIMS - ALL YEARS



STAINLESS STEEL
TF-1414

CASCADIA UPPER SLEEPER WINDOW TRIMS



STAINLESS STEEL
TF-1412 2008-2017
TF-1455 2018+

TECHNICAL SPECIFICATIONS

FREIGHTLINER MODEL

CASCADIA (All Years)

WHAT'S INCLUDED	3M Tape (Double Sided)
SOLD	As a Pair
WARRANTY	1 Year

Install using supplied 3M Tape.

TECHNICAL SPECIFICATIONS

FREIGHTLINER MODEL

CASCADIA (All Years)

WHAT'S INCLUDED	3M Tape (Double Sided)
SOLD	As a Kit
WARRANTY	1 Year

Install using supplied 3M Tape.

TECHNICAL SPECIFICATIONS

FREIGHTLINER MODEL

TF-1412: CASCADIA (2008-2017)
TF-1455: CASCADIA (2018+)

WHAT'S INCLUDED	3M Tape (Double Sided)
SOLD	As a Pair
WARRANTY	1 Year

Install using supplied 3M Tape.

CASCADIA BAGGAGE DOOR TRIMS - ALL YEARS



STAINLESS STEEL
TF-1413

TECHNICAL SPECIFICATIONS

FREIGHTLINER MODEL

CASCADIA (All Years)

WHAT'S INCLUDED	3M Tape (Double Sided)
SOLD	As a Pair
WARRANTY	1 Year

Install using supplied 3M Tape.



FREIGHTLINER TRIMS

CENTURY GRILLE SURROUND ALL YEARS



STAINLESS STEEL
TF-1105

TECHNICAL SPECIFICATIONS

FREIGHTLINER MODEL

CENTURY CLASS (All Years)

WHAT'S INCLUDED	Grille Trim & Deflectors, All Hardware
SOLD	As a Kit (3 Pieces)
WARRANTY	1 Year

Drilling required. Install using supplied Hardware.

CORONADO LOWER GRILLE TRIMS - PRE-2010



STAINLESS STEEL
TF-1108

TECHNICAL SPECIFICATIONS

FREIGHTLINER MODEL

CORONADO (Pre-2010)

WHAT'S INCLUDED	Hardware
SOLD	Individually
WARRANTY	1 Year

Install to the lower grille using supplied Hardware.

CORONADO HEADLIGHT FENDER GUARDS



STAINLESS STEEL
TF-1209

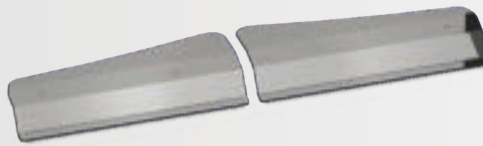

STAINLESS STEEL
TF-1210 Set Forward Axle



STAINLESS STEEL
TF-1212 Set Back Axle

TECHNICAL SPECIFICATIONS

FREIGHTLINER MODELS

TF-1209: CORONADO (Pre-2010)

TF-1210: CORONADO Set Forward Axle (2010+)

TF-1212: CORONADO Set Back Axle (2010+)

WHAT'S INCLUDED	Hardware
SOLD	As a Pair
WARRANTY	1 Year

Install using supplied Hardware.

 **WARNING:** Cancer and Reproductive Harm - www.p65warnings.ca.gov

CORONADO HEADLIGHT SURROUND FENDER GUARDS - 2010+

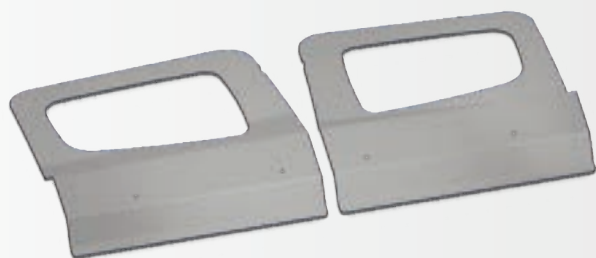

▲
STAINLESS STEEL
TF-1211

TECHNICAL SPECIFICATIONS

SET FORWARD AXLE MODEL

CORONADO (2010+)

WHAT'S INCLUDED	Hardware
SOLD	As a Pair
WARRANTY	1 Year

Install using supplied Hardware.

CORONADO UNDER DOOR WINDOW TRIMS - 2010+



▲
STAINLESS STEEL
TF-1422

TECHNICAL SPECIFICATIONS

FREIGHTLINER MODEL

CORONADO (2010+)

WHAT'S INCLUDED	3M Tape (Double Sided)
SOLD	As a Pair
WARRANTY	1 Year

Install using supplied 3M Tape.

CORONADO DOOR WINDOW SHADES - 2010+



▲
STAINLESS STEEL
TF-1427

TECHNICAL SPECIFICATIONS

FREIGHTLINER MODEL

CORONADO (2010+)

WHAT'S INCLUDED	3M Tape (Double Sided)
SOLD	As a Pair
WARRANTY	1 Year

Install using supplied 3M Tape.

CORONADO BATTERY BOX COVERS - PRE-2010

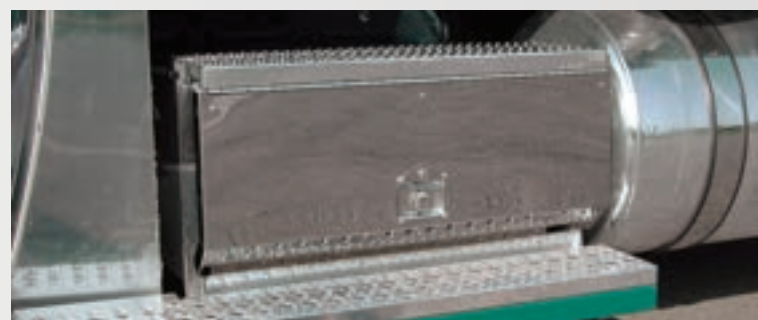

▲
STAINLESS STEEL
TF-1608

TECHNICAL SPECIFICATIONS

FREIGHTLINER MODEL

CORONADO (Pre-2010)

DIMENSIONS	Width: 36"
WHAT'S INCLUDED	3M Tape (Double Sided) & Hardware
SOLD	Individually
WARRANTY	1 Year

Install using supplied 3M Tape & Hardware.

FREIGHTLINER TRIMS

COLUMBIA GRILLE PANEL OEM REPLACEMENT - ALL YEARS



STAINLESS STEEL
TF-1706

TECHNICAL SPECIFICATIONS

FREIGHTLINER MODEL

COLUMBIA (All Years)

SOLD	Individually
WARRANTY	1 Year

No mounting hardware is required.

COLUMBIA HOOD & CAB TRIMS - ALL YEARS



STAINLESS STEEL
TF-1106

TECHNICAL SPECIFICATIONS

FREIGHTLINER MODEL

COLUMBIA (All Years)

WHAT'S INCLUDED	3M Tape (Double Sided)
SOLD	As a Kit (6 Pieces)
WARRANTY	1 Year

Install using supplied 3M Tape.

COLUMBIA FENDER TRIMS - WHEEL WELL - ALL YEARS



STAINLESS STEEL
TFT-FLCOL

TECHNICAL SPECIFICATIONS

FREIGHTLINER MODEL

COLUMBIA (All Years)

WHAT'S INCLUDED	3M Tape (Double Sided)
SOLD	As a Pair
WARRANTY	1 Year

Install using supplied 3M Tape.

COLUMBIA FENDER GUARDS ALL YEARS



STAINLESS STEEL
TF-1208

TECHNICAL SPECIFICATIONS

FREIGHTLINER MODEL

COLUMBIA (All Years)

WHAT'S INCLUDED	Hardware
SOLD	Individually
WARRANTY	1 Year

Mount onto the fender with supplied Hardware.

 **WARNING: Cancer and Reproductive Harm - www.p65warnings.ca.gov**

BUSINESS CLASS CHROME INTAKE GRILLE



▲
STAINLESS STEEL
TF-1111

TECHNICAL SPECIFICATIONS

BUSINESS CLASS MODELS

M2 106 & M2 112 (All Years)

DIMENSIONS	Length: 22.75"
SOLD	Individually
WARRANTY	1 Year

Install using existing Hardware. Replaces existing OEM Grille.

FLD 120 SIDE GRILLE DEFLECTOR - 1991+



▲
STAINLESS STEEL
TF-1104

TECHNICAL SPECIFICATIONS

FREIGHTLINER MODEL

FLD 120 (1991+)

WHAT'S INCLUDED	Hardware
SOLD	Individually
WARRANTY	1 Year

Drilling is required. Install behind Grille Bezel using supplied Hardware.

CLASSIC LOUVERED GRILLE BARS - 2006+



▲
STAINLESS STEEL
TF-1003

TECHNICAL SPECIFICATIONS

FREIGHTLINER MODEL

CLASSIC (2006+)

WHAT'S INCLUDED	14 Bars & Hardware
SOLD	As a Kit
WARRANTY	1 Year

Install to the front fender using supplied Hardware.

CLASSIC FENDER GUARDS - ALL YEARS



▲
STAINLESS STEEL
TF-1203

TECHNICAL SPECIFICATIONS

SHORT HOOD MODELS

CLASSIC (All Years)

WHAT'S INCLUDED	Hardware Kit
SOLD	As a Pair
WARRANTY	1 Year

Mounts to the fender below the headlights.

CLASSIC DOOR WINDOW SHADES - ALL YEARS



▲
STAINLESS STEEL
TF-1401

TECHNICAL SPECIFICATIONS

FREIGHTLINER MODELS

CLASSIC, XL FLD-112/120 (All Years)

WHAT'S INCLUDED	3M Tape (Double Sided) & Hardware
SOLD	As a Pair
WARRANTY	1 Year

Install using supplied 3M Tape & Hardware.

CLASSIC BATTERY & TOOL BOX PANELS - 2007+

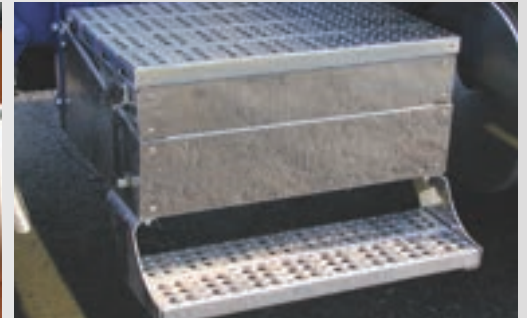

▲
STAINLESS STEEL
TF-1601

TECHNICAL SPECIFICATIONS

FREIGHTLINER MODEL

CLASSIC (2007+)

DIMENSIONS	Width: 31"
WHAT'S INCLUDED	Silicone & Hardware
SOLD	As a Kit (4 Pieces)
WARRANTY	1 Year

Install panels to battery tool box with bolts & supplied Silicone Adhesive.

17" RAISED ROOF SUN VISOR - 2003-2018



STAINLESS STEEL
TSUN-V1 8 x 6" Slotted

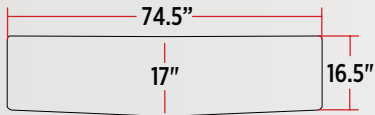

TECHNICAL SPECIFICATIONS

RAISED ROOF MODELS

VN670, VN730, VN780 & VT800 (2003-2018)

DIMENSIONS	Width: 74.5" Sides: 16.5" Drop: 17"
WHAT'S INCLUDED	2 x Sun Visor Brackets & All Hardware
WARRANTY	1 Year

OEM Replacement. Remove original factory brackets and install using TRUX brackets. For installation instructions visit our website.

VN/VH SUN VISOR TRIM SUN VISOR - 2003-2014



STAINLESS STEEL
TSUN-V2

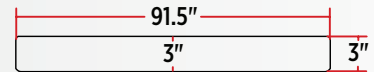

TECHNICAL SPECIFICATIONS

RAISED ROOF OEM REPLACEMENT MODELS

ALL VN & VH MODELS (2003-2014)

DIMENSIONS	Width: 91.5" Sides: 3" Drop: 3"
WHAT'S INCLUDED	3M Tape (Double Sided) & Hardware
WARRANTY	1 Year

Install using 3M Tape & supplied Hardware.

VN BUG DEFLECTOR HOOD SHIELD - 2003-2018



STAINLESS STEEL
THOD-VN

TECHNICAL SPECIFICATIONS

VOLVO MODELS

VN630, VN670, VN730 & VN780 (2003-2018)

DIMENSIONS	Width: 58"
WHAT'S INCLUDED	All Hardware
WARRANTY	1 Year

Drilling of mounting holes through the hood is required. Install using supplied Hardware.

SLEEPER CAB TRIM 2003-2018



STAINLESS STEEL
TV-1404

TECHNICAL SPECIFICATIONS

VOLVO MODELS

VN730, VN780 & VT880 (2003-2018)

WHAT'S INCLUDED	3M Tape (Double Sided)
SOLD	As a Pair
WARRANTY	1 Year

Install using 3M Tape.

VN SURROUND BUG DEFLECTOR & GRILLE KIT

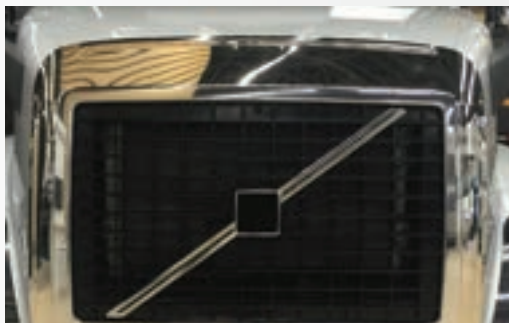

STAINLESS STEEL
TV-1104

TECHNICAL SPECIFICATIONS

VOLVO MODELS

VN 630, VN670, VN730 & VN780
(2003-2018)

WHAT'S INCLUDED	Hardware Kit
SOLD	As a Kit (4 Pieces)
WARRANTY	1 Year

Designed with a built in grab handle for hood tilting.
Drilling of mounting holes through the hood is required.

VN/VT FENDER GUARDS - 2003-2018



STAINLESS STEEL
TV-1203

TECHNICAL SPECIFICATIONS

VOLVO MODELS

VN 730, VN780 & VT880 (2003-2018)

WHAT'S INCLUDED	3M Tape (Double Sided)
SOLD	As a Pair
WARRANTY	1 Year

Install using 3M Tape.

VN BUMPER CENTRAL TRIM - 2003-2018



STAINLESS STEEL
TV-1701

TECHNICAL SPECIFICATIONS

VOLVO MODELS

ALL VN MODELS (2003-2018)

WHAT'S INCLUDED	3M Tape (Double Sided)
SOLD	Individually
WARRANTY	1 Year

Install using 3M Tape.

VN AIR INTAKE GRILLE 2003-2018



CHROME PLASTIC
TV-1102 Driver Side



CHROME PLASTIC
TV-1103 Passenger Side

TECHNICAL SPECIFICATIONS

VOLVO MODELS

ALL VN MODELS (2003-2018)

WHAT'S INCLUDED	3M Tape (Double Sided)
SOLD	Individually
WARRANTY	1 Year

Install using 3M Tape.

VN FENDER TRIMS SIDE FAIRING - 2003-2018

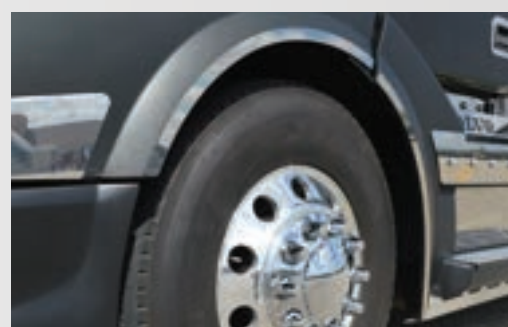

STAINLESS STEEL
TFT-VN

TECHNICAL SPECIFICATIONS

MODELS WITH SIDE FAIRING

ALL VN MODELS (2003-2018)

WHAT'S INCLUDED	3M Tape (Double Sided)
SOLD	As a Pair
WARRANTY	1 Year

Install using 3M Tape.

VN UPPER KICK PLATE PANELS 2003-2018



STAINLESS STEEL
TV-1406

TECHNICAL SPECIFICATIONS

VOLVO MODELS

ALL VN MODELS (2003-2018)

WHAT'S INCLUDED	3M Tape (Double Sided)
SOLD	As a Pair
WARRANTY	1 Year

Install using 3M Tape.



STAINLESS STEEL
TV-1436 With Volvo Cutout

TECHNICAL SPECIFICATIONS

VOLVO MODELS

ALL VN MODELS (2003-2018)

WHAT'S INCLUDED	3M Tape (Double Sided)
SOLD	As a Pair
WARRANTY	1 Year

VN LOWER KICK PLATE PANELS 2006-2018

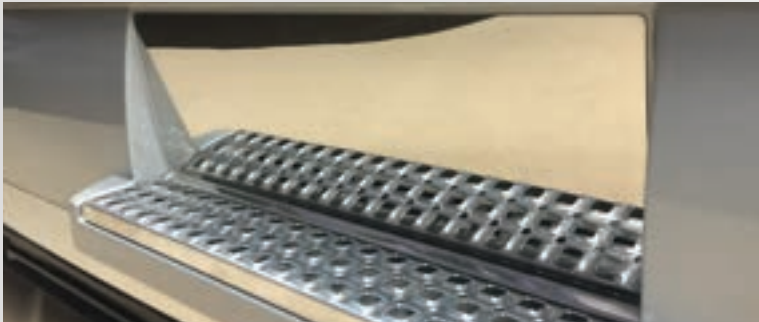

STAINLESS STEEL
TV-1408 Front

TECHNICAL SPECIFICATIONS

VOLVO MODELS

ALL VN MODELS (2006-2018)

WHAT'S INCLUDED	3M Tape (Double Sided)
SOLD	As a Pair
WARRANTY	1 Year

Install using 3M Tape.



STAINLESS STEEL
TV-1421 Rear

TECHNICAL SPECIFICATIONS

VOLVO MODELS

ALL VN MODELS (2006-2018)

WHAT'S INCLUDED	3M Tape (Double Sided)
SOLD	As a Pair
WARRANTY	1 Year

VN/VNL/VT DOOR HANDLE TRIMS



STAINLESS STEEL
TV-1413

TECHNICAL SPECIFICATIONS

VOLVO MODELS

VN, VNL & VT (2003-2018)

WHAT'S INCLUDED	3M Tape (Double Sided)
SOLD	As a Pair
WARRANTY	1 Year

Install using 3M Tape.

VN630/VN670 SLEEPER VENT TRIMS



STAINLESS STEEL
TV-1415

TECHNICAL SPECIFICATIONS

VOLVO MODELS

VN630 & VN670 (2003-2018)

WHAT'S INCLUDED	3M Tape (Double Sided)
SOLD	As a Pair
WARRANTY	1 Year

Install using 3M Tape.

VN730/VN780 UPPER FAIRING TRIMS



STAINLESS STEEL
TV-1440 18 x Slotted Holes

TECHNICAL SPECIFICATIONS

VOLVO MODELS

VN730 & VN780 (2006-2011)

DIMENSIONS	Step: 17.5" Front Fender: 13.06" Front Step: 62.25" Sleeper: 69.125" Rear Step: 22.5
WHAT'S INCLUDED	3M Tape (Double Sided) & Hardware
SOLD	As a Kit (8 Pieces)
WARRANTY	1 Year

VN DOOR WINDOW SHADES PRE-2018



STAINLESS STEEL
TV-1462

TECHNICAL SPECIFICATIONS

VOLVO MODELS

ALL VN MODELS (Pre- 2018)

WHAT'S INCLUDED	3M Tape (Double Sided)
SOLD	As a Pair
WARRANTY	1 Year

Install using 3M Tape.

VN730/VN780 CAB & SLEEPER PANELS - 2003-2010

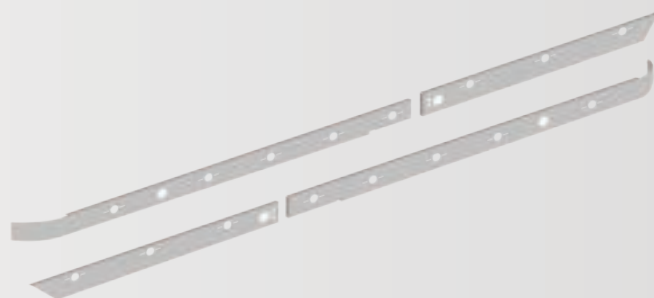

STAINLESS STEEL
TV-1002 16 x Slotted Holes

TECHNICAL SPECIFICATIONS

VOLVO MODELS

VN730 & VN780 (2003-2010)

DIMENSIONS	L: 43" W: 4"
WHAT'S INCLUDED	Hardware Kit
SOLD	As a Kit (4 Pieces)
WARRANTY	1 Year

Install using supplied Hardware.

INTERNATIONAL

12" OEM SUN VISOR - 2008+



STAINLESS STEEL
TSUN-I1 5 x Slotted Holes

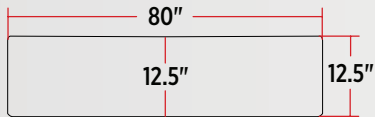

TECHNICAL SPECIFICATIONS

OEM VISOR MODELS

LONESTAR, PROSTAR, TERRASTAR, WORKSTAR (2008+)

DIMENSIONS	Width: 80" Sides: 12.5" Drop: 12.5"
WHAT'S INCLUDED	4 x Sun visor Brackets & All Hardware
WARRANTY	1 Year

Install by removing the original factory brackets & using Trux brackets. Visit our website to download the installation instructions.

11" 9000 SERIES SUN VISOR - PRE-1999



STAINLESS STEEL
TSUN-I2

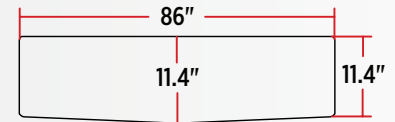

TECHNICAL SPECIFICATIONS

LOW ROOF/HIGH RISE/DAY CAB MODELS

9000 SERIES (Pre-1999)

DIMENSIONS	Width: 86" Sides: 11.4" Drop: 11.4"
WHAT'S INCLUDED	5 x Sun visor Brackets & All Hardware
WARRANTY	1 Year

Install by removing the original factory brackets & using Trux brackets. Visit our website to download the installation instructions.

12.5" 9000 SERIES SUN VISOR - 1999+



STAINLESS STEEL
TSUN-I5 Blank
TSUN-I7 8 x Slotted Holes

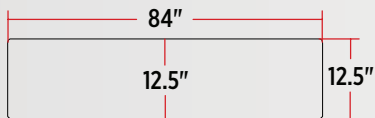

TECHNICAL SPECIFICATIONS

LOW ROOF/HIGH RISE/SKY RISE MODELS

9000 SERIES (1999+)

DIMENSIONS	Width: 84" Sides: 12.5" Drop: 12.5"
WHAT'S INCLUDED	5 x Sun visor Brackets & All Hardware
WARRANTY	1 Year

Install by removing the original factory brackets & using Trux brackets. Visit our website to download the installation instructions.

12" 9000 SERIES DAY CAB WITH ROOF DEFLECTOR - 1999+



STAINLESS STEEL
TSUN-I8 Blank
TSUN-I9 5 x Slotted Holes

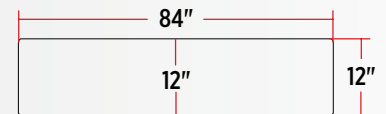

TECHNICAL SPECIFICATIONS

DAY CAB WITH ROOF DEFLECTOR MODELS

9000 SERIES (1999+)

DIMENSIONS	Width: 84" Sides: 12" Drop: 12."
WHAT'S INCLUDED	5 x Sun visor Brackets & All Hardware
WARRANTY	1 Year

Install by removing the original factory brackets & using Trux brackets. Visit our website to download the installation instructions.

WARNING: Cancer and Reproductive Harm - www.p65warnings.ca.gov

12" 4000 SERIES SUN VISOR - 2002+



STAINLESS STEEL

TSUN-I11 Blank

TSUN-I12 5 x 2" Holes

TSUN-I10 6 x Slotted Holes

TSUN-I18 20 x 3/4" Holes

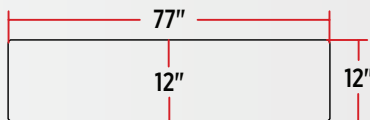

TECHNICAL SPECIFICATIONS

INTERNATIONAL MODELS

4000 SERIES (2002+)

DIMENSIONS	Width: 77" Sides: 12" Drop: 12"
WHAT'S INCLUDED	4 x Sun visor Brackets & All Hardware
WARRANTY	1 Year

Install by removing the original factory brackets & using Trux brackets. Visit our website to download the installation instructions.

PROSTAR BUG DEFLECTOR HOOD SHIELD - 2008+



STAINLESS STEEL

THOD-INPR

TECHNICAL SPECIFICATIONS

INTERNATIONAL MODEL

PROSTAR (2008+)

DIMENSIONS	Width: 57.38"
WHAT'S INCLUDED	All Hardware
WARRANTY	1 Year

Install using supplied Hardware. Drilling into hood is required.

4000 SERIES BUG DEFLECTOR HOOD SHIELD - 2002+



STAINLESS STEEL

THOD-IN40

TECHNICAL SPECIFICATIONS

INTERNATIONAL MODELS

4000 SERIES (2002+)

DIMENSIONS	Width: 56.625"
WHAT'S INCLUDED	All Hardware
WARRANTY	1 Year

Install using supplied Hardware. Drilling into hood is

LONESTAR BUG DEFLECTOR HOOD SHIELD - ALL YEARS



STAINLESS STEEL

THOD-INLS

TECHNICAL SPECIFICATIONS

INTERNATIONAL MODEL

LONESTAR (All Years)

DIMENSIONS	Width: 35" per Side
WHAT'S INCLUDED	All Hardware
WARRANTY	1 Year

Install using supplied Hardware. Drilling into hood is required.

INTERNATIONAL

BUG DEFLECTOR HOOD SHIELD - ALL YEARS



▲
STAINLESS STEEL
THOD-IN92

TECHNICAL SPECIFICATIONS

INTERNATIONAL MODELS

5900 ROUND HOOD, 9100, 9200 & 9400 (All Years)

DIMENSIONS	Width: 60.21"
WHAT'S INCLUDED	All Hardware
WARRANTY	1 Year

Install using supplied Hardware. Drilling into hood is required.

5900 ROUND HOOD/9400 BUG DEFLECTOR HOOD SHIELD - ALL YEARS



▲
STAINLESS STEEL
THOD-IN94

TECHNICAL SPECIFICATIONS

INTERNATIONAL MODELS

5900 ROUND HOOD & 9400 (All Years)

DIMENSIONS	Width: 60.21"
WHAT'S INCLUDED	All Hardware
WARRANTY	1 Year

Install using supplied Hardware. Drilling into hood is required.

9300 BUG DEFLECTOR HOOD SHIELD - ALL YEARS



▲
STAINLESS STEEL
THOD-IN93

TECHNICAL SPECIFICATIONS

INTERNATIONAL MODEL

9300 (All Years)

DIMENSIONS	Width: 55.56"
WHAT'S INCLUDED	All Hardware
WARRANTY	1 Year

Install using supplied Hardware. Drilling into hood is required.

BUG DEFLECTOR HOOD SHIELD



▲
STAINLESS STEEL
THOD-IN99

TECHNICAL SPECIFICATIONS

INTERNATIONAL MODELS

HX520 (2017+)
5900 FLAT HOOD, 9900 & 9900i (All Years)

DIMENSIONS	Width: 59.2"
WHAT'S INCLUDED	All Hardware
WARRANTY	1 Year

Install using supplied Hardware. Drilling into hood is required.

▲ WARNING: Cancer and Reproductive Harm - www.p65warnings.ca.gov

4000 SERIES/DURASTAR BUMPER BAR



STAINLESS STEEL
TI-1703 16 x 2" Holes

TECHNICAL SPECIFICATIONS

INTERNATIONAL MODELS

4000 SERIES & DURASTAR (All Years)

SOLD	Individually
WARRANTY	1 Year

Drilling maybe required.

PROSTAR BUMPER INSERT - PRE-2012



STAINLESS STEEL
TI-1708

TECHNICAL SPECIFICATIONS

INTERNATIONAL MODEL

PROSTAR (Pre-2012)

WHAT'S INCLUDED	3M Tape (Double Sided)
SOLD	Individually
WARRANTY	1 Year

Install using supplied 3M Tape.

9900I/9900IX GRILLE HORIZONTAL BARS



STAINLESS STEEL
TI-1103

TECHNICAL SPECIFICATIONS

INTERNATIONAL MODELS

9900I & 9900IX (All Years)

WHAT'S INCLUDED	Grille Bars & Bug Screen
SOLD	Individually
WARRANTY	1 Year

Sold completely assembled with the bug screen included.
Install using existing Hardware.

AIR FILTER SHROUDS



STAINLESS STEEL
TI-1104

TECHNICAL SPECIFICATIONS

MODELS WITH AIR FILTER

9300/9900 (2016+)
HX515, HX520, HX615 & HX620
(2016+)

WHAT'S INCLUDED	Hardware Kit
SOLD	As a Pair
WARRANTY	1 Year

Install using supplied Hardware.

PROSTAR CAB PANELS 2007+



STAINLESS STEEL
TI-1301 4 x Slotted Holes

TECHNICAL SPECIFICATIONS

INTERNATIONAL MODEL

PROSTAR (2007+)

DIEMENSIONS	L: 36" W: 5.6"
SOLD	As a Pair
WARRANTY	1 Year

Mount underneath cab, drilling maybe required.

LONESTAR/PROSTAR BAGGAGE DOOR TRIMS



STAINLESS STEEL
TI-1411 Inner Trim

TECHNICAL SPECIFICATIONS

56" & 73" SLEEPER MODELS

LONESTAR & PROSTAR (All Years)

WHAT'S INCLUDED	3M Tape (Double Sided)
SOLD	As a Pair
WARRANTY	1 Year

Install using supplied 3M Tape.

13" SUN VISOR ALL YEARS



STAINLESS STEEL
TSUN-M1

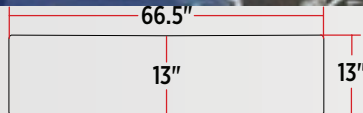

TECHNICAL SPECIFICATIONS

MACK MODELS

GRANITE CH/CL/CX/CT/GU With Roof Fairings (All Years)
ANTHEM Without Roof Fairings (All Years)

DIMENSIONS	Width: 66.5" Sides: 13" Drop: 13"
WHAT'S INCLUDED	8 x Sun Visor Brackets & All Hardware
WARRANTY	1 Year

2 Piece Sun visor. Visit our website at www.truxaccessories.com for Installation Instructions.

7.5" R SERIES SUN VISOR - 1994+



STAINLESS STEEL
TSUN-M2

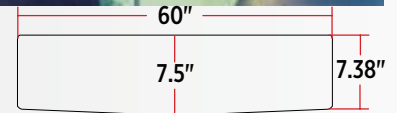

TECHNICAL SPECIFICATIONS

MACK MODELS

R SERIES (1994+)

DIMENSIONS	Width: 60" Sides: 7.38" Drop: 7.5"
WHAT'S INCLUDED	3 x Sun Visor Brackets & All Hardware
WARRANTY	1 Year

Installation does not require drilling, remove the original factory brackets & use TRUX brackets. Visit our website at www.truxaccessories.com for Installation Instructions.

12" R SERIES SUN VISOR - PRE-2006

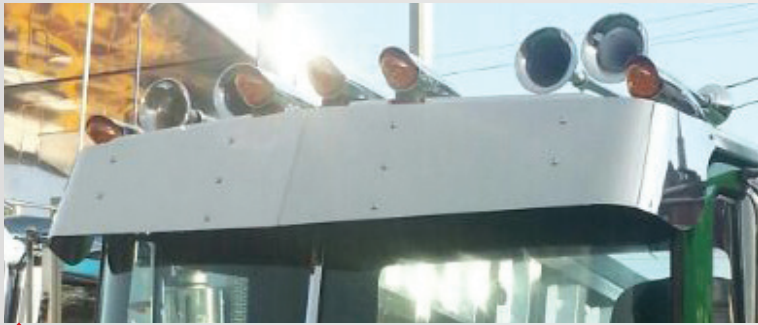

STAINLESS STEEL
TSUN-M3

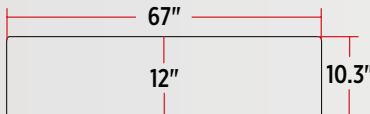

TECHNICAL SPECIFICATIONS

MACK MODELS

R SERIES (Pre-2006)

DIMENSIONS	Width: 67" Sides: 10.3" Drop: 12"
WHAT'S INCLUDED	4 x Sun Visor Brackets & All Hardware
WARRANTY	1 Year

2 Piece Sun Visor. Visit our website at www.truxaccessories.com for Installation Instructions.

PINNACLE/VISION AIR INTAKE TRIMS - ALL YEARS



STAINLESS STEEL
TM-1102 Outer Air Intake Trim
TM-1417 Inner Air Intake Trim

TECHNICAL SPECIFICATIONS

MACK MODELS

PINNACLE (All Years)
VISION (All Years)

WHAT'S INCLUDED	3M Tape (Double Sided)
SOLD	As a Kit
WARRANTY	1 Year

Install using supplied 3M Tape.

WARNING: Cancer and Reproductive Harm - www.p65warnings.ca.gov

CT/GU BUG DEFLECTOR HOOD SHIELD



▲
STAINLESS STEEL
THOD-MGCT

TECHNICAL SPECIFICATIONS

MACK MODEL

GRANITE CT (2006-2010)
GRANITE GU (2011+)

DIMENSIONS	Width: 60.76"
WHAT'S INCLUDED	All Hardware
WARRANTY	1 Year

Drilling of mounting holes through the hood is required. Install using supplied Hardware.

CH BUG DEFLECTOR HOOD SHIELD - PRE-2016



▲
STAINLESS STEEL
THOD-MCH

TECHNICAL SPECIFICATIONS

MACK MODEL

CH (Pre-2016)

DIMENSIONS	Width: 52.2"
WHAT'S INCLUDED	All Hardware
WARRANTY	1 Year

Drilling of mounting holes through the hood is required. Install using supplied Hardware.

CH AIR INTAKE GRILLE TRIMS - OEM REPLACEMENT



▲
STAINLESS STEEL
TM-1412 Grille
TM-1427 Grille Surround with Logo

TECHNICAL SPECIFICATIONS

MACK MODEL

CH (All Years)

WHAT'S INCLUDED	Hardware Kit
SOLD	As a Pair
WARRANTY	1 Year

Replace OEM plastic panels with TRUX Stainless panels by installing with supplied Hardware.

VISION GRILLE SURROUND - PRE-2007



▲
STAINLESS STEEL
TM-1101

TECHNICAL SPECIFICATIONS

MACK MODEL

VISION (Pre-2007)

WHAT'S INCLUDED	Hardware Kit
SOLD	As a Pair
WARRANTY	1 Year

Acts as a Bug & Grille Deflector. Drilling into the hood may be required. Install to the hood using supplied Hardware.

CH GRILLE SURROUND - ALL YEARS



▲
STAINLESS STEEL
TM-1107

TECHNICAL SPECIFICATIONS

SET FORWARD AXLE MODEL

CH (All Years)

WHAT'S INCLUDED	Hardware Kit
SOLD	As a Kit (4 Pieces)
WARRANTY	1 Year

Acts as a Bug & Grille Deflector. Drilling into the hood may be required. Install to the hood using supplied Hardware.

VISION FENDER TRIMS 1993+



STAINLESS STEEL
TFT-MVIS

TECHNICAL SPECIFICATIONS

MACK MODEL

VISION (1993+)

WHAT'S INCLUDED	3M Tape (Double Sided)
SOLD	As a Kit
WARRANTY	1 Year

Install using supplied 3M Tape.

CH FENDER GUARDS SET FORWARD AXLE - ALL YEARS



STAINLESS STEEL
TM-1202

TECHNICAL SPECIFICATIONS

SET FORWARD AXLE MODEL

CH (All Years)

WHAT'S INCLUDED	Hardware & 3M Tape (Double Sided)
SOLD	As a Pair
WARRANTY	1 Year

Install using supplied 3M Tape & Hardware.

KICK PLATES WITH MACK CUT-OUT ALL YEARS



STAINLESS STEEL
TM-1605 Old Logo



STAINLESS STEEL
TM-1606 New Logo

TECHNICAL SPECIFICATIONS

MACK MODELS

ANTHEM, GRANITE, PINNACLE, RAWHIDE & VISION (All Years)

WHAT'S INCLUDED	3M Tape (Double Sided)
SOLD	As a Pair
WARRANTY	1 Year

Install using supplied 3M Tape & existing Hardware.

FIRE WALL LIGHT BARS - ALL YEARS



STAINLESS STEEL
TM-1801 16 x 2" Holes
TM-1802 16 x 3/4" Holes

TECHNICAL SPECIFICATIONS

MACK MODELS

ALL MODELS (All Years)

DIMENSIONS	15.5" High
WHAT'S INCLUDED	Hardware Kit
SOLD	As a Pair
WARRANTY	1 Year

Install using supplied Hardware.

WARNING: Cancer and Reproductive Harm - www.p65warnings.ca.gov

DOOR HANDLE TRIMS 1993+



STAINLESS STEEL
TM-1403

TECHNICAL SPECIFICATIONS

MACK MODELS

GRANITE, PINNACLE, VISION & ANTHEM (1993+)

WHAT'S INCLUDED	3M Tape (Double Sided)
SOLD	As a Pair
WARRANTY	1 Year

Install using supplied 3M Tape.

DOOR WINDOW SHADES ALL YEARS



STAINLESS STEEL
TM-1413

TECHNICAL SPECIFICATIONS

MACK MODELS

ANTHEM, CH, GRANITE & VISION (All Years)

WHAT'S INCLUDED	3M Tape (Double Sided)
SOLD	As a Pair
WARRANTY	1 Year

Install using supplied 3M Tape & Hardware.

GRANITE / ANTHEM DOOR WINDOW TRIMS



STAINLESS STEEL
TM-1429

TECHNICAL SPECIFICATIONS

MACK MODELS

GRANITE (2002+) ANTHEM (2019+)

WHAT'S INCLUDED	3M Tape (Double Sided)
SOLD	As a Pair
WARRANTY	1 Year

Install using supplied 3M Tape.

GRANITE INTAKE GRILLE ALL YEARS



STAINLESS STEEL
TM-1109 Driver Side
TM-1110 Passenger Side

TECHNICAL SPECIFICATIONS

OLDER STYLE HOOD MODELS

GRANITE (All Years)

WHAT'S INCLUDED	3M Tape (Double Sided)
SOLD	Individually
WARRANTY	1 Year

Install using supplied 3M Tape.

WESTERN STAR

13.5" FLAT TOP SUN VISOR - 1998+ EXCEPT 2006



STAINLESS STEEL
TSUN-W1

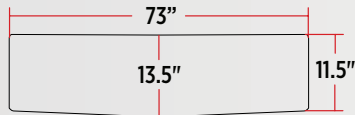

TECHNICAL SPECIFICATIONS

MODELS WITH DOOR MOUNTED MIRRORS

CONSTELLATION & STRATOSPHERE (1998+ except 2006)

DIMENSIONS	Width: 73" Sides: 11.5 Drop: 13.5"
WHAT'S INCLUDED	5 x Sun Visor Brackets & All Hardware
WARRANTY	1 Year

Visit our website at www.truxaccessories.com for Installation Instructions. Drilling may be required.

11" HERITAGE SUN VISOR - 1987-2006



STAINLESS STEEL
TSUN-W2

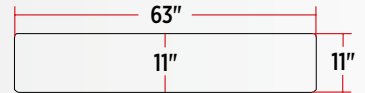

TECHNICAL SPECIFICATIONS

MODELS WITH OEM SUN VISOR

HERITAGE (1987-2006)

DIMENSIONS	Width: 63" Sides: 11" Drop: 11"
WHAT'S INCLUDED	6 x Sun Visor Brackets & All Hardware
WARRANTY	1 Year

Will NOT fit EPA-2007 Models. Visit our website at www.truxaccessories.com for Installation Instructions. Drilling may be required.

16" STRATOSPHERE SUN VISOR - ALL YEARS



STAINLESS STEEL
TSUN-W3

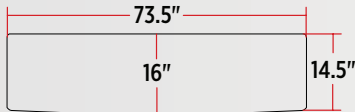

TECHNICAL SPECIFICATIONS

STRATOSPHERE MODELS WITH OEM SUN VISOR

STRATOSPHERE (All Years)

DIMENSIONS	Width: 73.5" Sides: 14.5" Drop: 16"
WHAT'S INCLUDED	5 x Sun Visor Brackets & All Hardware
WARRANTY	1 Year

Visit our website at www.truxaccessories.com for Installation Instructions. Drilling may be required.

15" MID ROOF SUN VISOR - ALL YEARS



STAINLESS STEEL
TSUN-W8

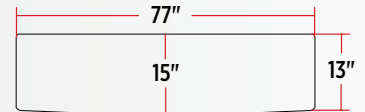

TECHNICAL SPECIFICATIONS

MODELS WITH CAB MOUNTED MIRRORS

ALL MODELS (All Years)

DIMENSIONS	Width: 77" Sides: 13" Drop: 15"
WHAT'S INCLUDED	5 x Sun Visor Brackets & All Hardware
WARRANTY	1 Year

In addition this Sun Visor is sold with 1 Center Leg and 1 Reinforcement Bar that holds the 2 piece windshield. Visit our website at www.truxaccessories.com for Installation Instructions. Drilling may be required.

WARNING: Cancer and Reproductive Harm - www.p65warnings.ca.gov

BUG DEFLECTOR HOOD SHIELD - 2000+



▲
STAINLESS STEEL
THOD-WCF

TECHNICAL SPECIFICATIONS

WESTERN STAR MODELS

**CONSTELLATION, HERITAGE,
4964 & 4900 (FX/FA, EX, SX/SA) (2000+)**

DIMENSIONS	Width: 49"
WHAT'S INCLUDED	All Hardware
WARRANTY	1 Year

Will not fit on models with high visibility hoods or SD models. Drilling of mounting holes through the hood is required.

4900EX/FA BUG DEFLECTOR HOOD SHIELD - 1993-2011



▲
STAINLESS STEEL
THOD-WH

TECHNICAL SPECIFICATIONS

WESTERN STAR MODELS

4900EX & 4900FA (1993-2011)

DIMENSIONS	Width: 48"
WHAT'S INCLUDED	All Hardware
WARRANTY	1 Year

Drilling of mounting holes through the hood is required.

4700SB/SF BUG DEFLECTOR HOOD SHIELD - 2012+



▲
STAINLESS STEEL
THOD-WSB

TECHNICAL SPECIFICATIONS

WESTERN STAR MODELS

4700SB & 4700SF (2012+)

DIMENSIONS	Width: 54"
WHAT'S INCLUDED	All Hardware
WARRANTY	1 Year

Drilling of mounting holes through the hood is required.

4900CO BUG DEFLECTOR HOOD SHIELD - 1993-2011



▲
STAINLESS STEEL
THOD-WC

TECHNICAL SPECIFICATIONS

WESTERN STAR MODEL

4900CO (1993-2011)

DIMENSIONS	Width: 46.5"
WHAT'S INCLUDED	All Hardware
WARRANTY	1 Year

Drilling of mounting holes through the hood is required.

WESTERN STAR

4900EX GRILLE KIT REPLACES OEM - 1995+



STAINLESS STEEL
TW-1101

TECHNICAL SPECIFICATIONS

WESTERN STAR MODEL

4900EX OEM 67205-3479 & 67205-3481

DIMENSIONS	W: 42" H: 33.59"
WHAT'S INCLUDED	Brackets and Hardware
SOLD	As a Kit
WARRANTY	1 Year

Install using supplied Hardware. Drilling may be required.
NOTE: Does not include the Bug Deflector.

4700SB GRILLE SURROUND 2012+



STAINLESS STEEL
TW-1105

TECHNICAL SPECIFICATIONS

WESTERN STAR MODEL

4700SB (2012+)

WHAT'S INCLUDED	Hardware
SOLD	As a Kit
WARRANTY	1 Year

Install using supplied hardware. Drilling may be required.

CONSTELLATION HEADLIGHT FENDER GUARDS - 1996-2009



STAINLESS STEEL
TW-1203

TECHNICAL SPECIFICATIONS

WESTERN STAR MODEL

CONSTELLATION (1996-2009)

WHAT'S INCLUDED	Hardware
SOLD	As a Pair
WARRANTY	1 Year

Install using supplied Hardware. Drilling into hood is required.

4900EX/4900FA FENDER GUARDS - 2014-2018



STAINLESS STEEL
TW-1207

TECHNICAL SPECIFICATIONS

WESTERN STAR MODELS

4900EX & 4900FA (2014-2018)

WHAT'S INCLUDED	Hardware
SOLD	As a Pair
WARRANTY	1 Year

Install using supplied Hardware. Drilling into hood is required.

CAB MOUNTED WINDOW SHADES - ALL YEARS



STAINLESS STEEL
TW-1401

TECHNICAL SPECIFICATIONS

MODELS WITH CAB MOUNTED MIRRORS

ALL MODELS (All Years)

WHAT'S INCLUDED	3M Tape (Double Sided)
SOLD	As a Pair
WARRANTY	1 Year

Install using supplied 3M Tape. Drilling may be required.

DOOR MOUNTED WINDOW SHADES - ALL YEARS



STAINLESS STEEL
TW-1404

TECHNICAL SPECIFICATIONS

MODELS WITH DOOR MOUNTED MIRRORS

ALL MODELS (All Years)

WHAT'S INCLUDED	3M Tape (Double Sided)
SOLD	As a Pair
WARRANTY	1 Year

Install using supplied 3M Tape. Drilling may be required.

5" WINDOW CHOP TOPS 1998+



STAINLESS STEEL
TW-1407

TECHNICAL SPECIFICATIONS

MODELS WITH CAB MOUNTED MIRRORS

ALL MODELS (1998+)

WHAT'S INCLUDED	3M Tape (Double Sided)
SOLD	As a Pair
WARRANTY	1 Year

Install using supplied 3M Tape.

DOOR WINDOW TRIMS 2000+



STAINLESS STEEL
TW-1411

TECHNICAL SPECIFICATIONS

WESTERN STAR MODELS

ALL MODELS (2000+)

WHAT'S INCLUDED	3M Tape (Double Sided)
SOLD	As a Pair
WARRANTY	1 Year

Install using supplied 3M Tape.

NEW

STAY WARM WITH TRUX APPAREL

BOMBER
JACKET

SOFT SHELL
JACKET

SAFETY
PARKA

HEATED JACKETS

FRONT & BACK
MULTI-ZONE
HEATING ELEMENTS



MULTI-ZONE HEATING
UP TO 11* HOURS OF HEAT
*HEAT DURATION VARIES BASED ON JACKET MODEL

3 HEAT SETTINGS
BUTTON FOUND DISCRETELY IN THE JACKET



LOW

MEDIUM

HIGH



**BREATHABLE,
WATER & WIND RESISTANT**



M, L, XL, XXL
SIZES AVAILABLE

RECHARGEABLE
POWER BANK INCLUDED



SOFT SHELL JACKET

BLACK - HEATED



BLACK HEATED SOFT SHELL JACKET
TT-105M Medium
TT-105L Large
TT-105XL XL
TT-1052XL XXL

TECHNICAL SPECIFICATIONS

COLOR	Black
FUNCTION	3 Setting Heated Jacket
HEAT DURATION	Up to 7 Hours
MATERIAL	Shell: 94% Polyester, 6% Spandex Lining & Insulation: 100% Polyester
WASHING INSTRUCTIONS	Machine Washable, Gentle Cycle
WHAT'S INCLUDED	USB Power Bank & Charging Cable
POWER BANK	5V - 10,000 mAh (TT-109) Power Bank Certification: FCC, CE, RoHS Power Cell Certification: UL Certified
SOLD	Individually
WARRANTY	1 Year

BODY SIZE GUIDE

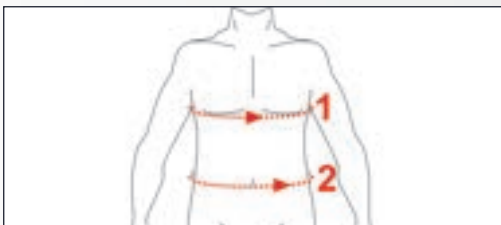

SIZE	M	L	XL	XXL
1	42" - 43"	44" - 45"	46" - 47"	48" - 49"
2	38" - 39"	40" - 41"	42" - 43"	43" - 44"

BOMBER JACKET

ORANGE - HEATED



ORANGE HEATED BOMBER JACKET
TT-104M Medium
TT-104L Large
TT-104XL XL
TT-1042XL XXL

TECHNICAL SPECIFICATIONS

COLOR	Orange
FUNCTION	3 Setting Heated Jacket
HEAT DURATION	Up to 7 Hours
MATERIAL	Outer Shell, Lining & Insulation: 100% Polyester, 3M Reflective Tape
WASHING INSTRUCTIONS	Machine Washable, Gentle Cycle
WHAT'S INCLUDED	USB Power Bank & Charging Cable
POWER BANK	5V - 10,000 mAh (TT-101) Power Bank Certification: FCC, CE, RoHS Power Cell Certification: UL Certified
SOLD	Individually
WARRANTY	1 Year

BODY SIZE GUIDE

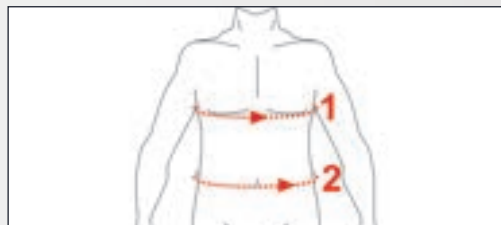

SIZE	M	L	XL	XXL
1	41" - 43"	44" - 46"	47" - 49"	50" - 52"
2	37" - 39"	40" - 42"	43" - 45"	46" - 48"

SAFETY PARKA

YELLOW - HEATED



YELLOW HEATED SAFETY PARKA
TT-103M Medium
TT-103L Large
TT-103XL XL
TT-1032XL XXL

TECHNICAL SPECIFICATIONS

COLOR	Yellow
FUNCTION	3 Setting Heated Jacket
HEAT DURATION	Up to 11 Hours
MATERIAL	Outer Shell, Lining & Insulation: 100% Polyester, 3M Reflective Tape
WASHING INSTRUCTIONS	Machine Washable, Gentle Cycle
WHAT'S INCLUDED	USB Power Bank & Charging Cable
POWER BANK	5V - 20,000 mAh (TT-102) Power Bank Certification: FCC, CE, RoHS Power Cell Certification: UL Certified
SOLD	Individually
WARRANTY	1 Year

BODY SIZE GUIDE

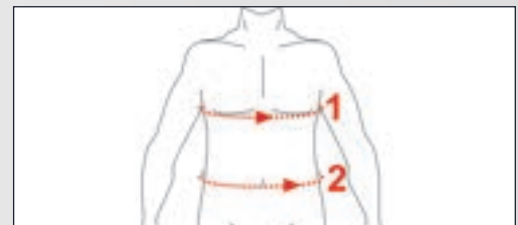

SIZE	M	L	XL	XXL
1	41" - 43"	44" - 46"	47" - 49"	50" - 52"
2	37" - 39"	40" - 42"	43" - 45"	46" - 48"

APPAREL

VEST LINER BLACK - HEATED



WEAR
UNDERNEATH
YOUR JACKET!

▲ **BLACK HEATED VEST LINER**
TT-106M Medium
TT-106L Large
TT-106XL XL
TT-1062XL XXL

TECHNICAL SPECIFICATIONS

COLOR	Black
FUNCTION	3 Setting Heated Jacket
HEAT DURATION	Up to 6 Hours
MATERIAL	Shell: 95% Polyester, 5% Spandex Lining: 100% Polyester
WASHING INSTRUCTIONS	Machine Washable, Gentle Cycle
WHAT'S INCLUDED	USB Power Bank & Charging Cable
POWER BANK	5V - 10,000 mAh (TT-109) Power Bank Certification: FCC, CE, RoHS Power Cell Certification: UL Certified
SOLD	Individually
WARRANTY	1 Year

BODY SIZE GUIDE

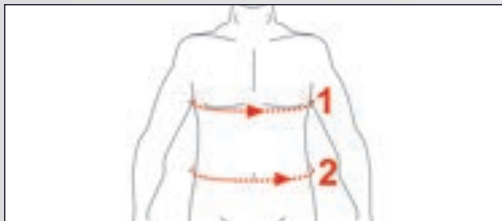

SIZE	M	L	XL	XXL
1	40" - 41"	42" - 43"	44" - 45"	46" - 47"
2	36" - 37"	38" - 39"	40" - 41"	42" - 43"

GLOVES BLACK - HEATED



▲ **BLACK HEATED GLOVES**
TT-107M Medium
TT-107L Large
TT-107XL XL
TT-1072XL XXL

TECHNICAL SPECIFICATIONS

COLOR	Black
FUNCTION	3 Setting Heated Gloves
HEAT DURATION	Up to 6 Hours
MATERIAL	Outer Shell: 100% Nylon Hand & Thumb Inserts: 60% Nylon, 40% Polyurethane Lining & Insulation: 100% Polyester
WASHING INSTRUCTIONS	Machine Washable, Gentle Cycle
WHAT'S INCLUDED	2 USB Power Banks & Charging Cable
POWER BANK	5V - 5000 mAh (TT-100) Power Bank Certification: FCC, CE, RoHS Power Cell Certification: UL Certified
SOLD	Individually
WARRANTY	1 Year

HAND SIZE GUIDE



SIZE	M	L	XL	XXL
1	8.1" - 8.5"	8.5" - 8.9"	8.9" - 9.2"	9.2" - 9.7"
2	7.6" - 7.9"	7.9" - 8.2"	8.2" - 8.5"	8.5" - 8.7"

MITTS BLACK - HEATED



▲ **BLACK HEATED MITTS**
TT-108M Medium
TT-108L Large
TT-108XL XL
TT-1082XL XXL

TECHNICAL SPECIFICATIONS

COLOR	Black
FUNCTION	3 Setting Heated Mitts
HEAT DURATION	Up to 6 Hours
MATERIAL	Outer Shell: 100% Nylon Hand & Thumb Inserts: 60% Nylon, 40% Polyurethane Lining & Insulation: 100% Polyester
WASHING INSTRUCTIONS	Machine Washable, Gentle Cycle
WHAT'S INCLUDED	2 USB Power Banks & Charging Cable
POWER BANK	5V - 5000 mAh (TT-100) Power Bank Certification: FCC, CE, RoHS Power Cell Certification: UL Certified
SOLD	Individually
WARRANTY	1 Year

HAND SIZE GUIDE

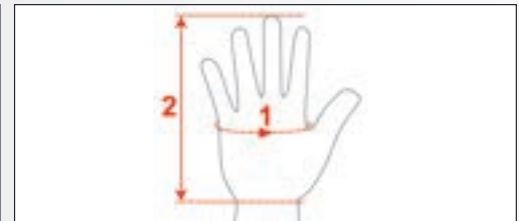

SIZE	M	L	XL	XXL
1	8.1" - 8.5"	8.5" - 8.9"	8.9" - 9.2"	9.2" - 9.7"
2	7.6" - 7.9"	7.9" - 8.2"	8.2" - 8.5"	8.5" - 8.7"

⚠️ **WARNING: Cancer and Reproductive Harm - www.p65warnings.ca.gov**

POWER BANK 10,000 MAH

FOR HEATED
SOFT SHELL JACKETS
& BOMBER JACKETS



POWER BANK
TT-101 10,000 mAh

TECHNICAL SPECIFICATIONS

COLOR	Silver
VOLTAGE	5 Volts
POWER	10,000 mAh
WHAT'S INCLUDED	USB Power Bank & Charging Cable
SOLD	Individually
WARRANTY	1 Year

POWER BANK 20,000 MAH

FOR HEATED PARKA

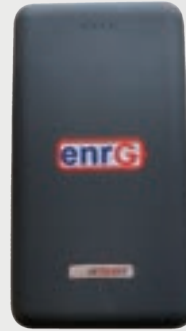

POWER BANK
TT-102 20,000 mAh

TECHNICAL SPECIFICATIONS

COLOR	Black
VOLTAGE	5 Volts
POWER	20,000 mAh
WHAT'S INCLUDED	USB Power Bank & Charging Cable
SOLD	Individually
WARRANTY	1 Year

POWER BANK 10,000 MAH

FOR HEATED VESTS



POWER BANK
TT-109 10,000 mAh

TECHNICAL SPECIFICATIONS

COLOR	Silver
VOLTAGE	5 Volts
POWER	10,000 mAh
WHAT'S INCLUDED	USB Power Bank & Charging Cable
SOLD	Individually
WARRANTY	1 Year

POWER BANK 5000 MAH

FOR HEATED
MITS & GLOVES



POWER BANK
TT-100 5000 mAh

TECHNICAL SPECIFICATIONS

COLOR	Black
VOLTAGE	5 Volts
POWER	5000 mAh
WHAT'S INCLUDED	USB Power Bank & Charging Cable
SOLD	Individually
WARRANTY	1 Year

**HEATED
GLOVES & MITTS**

PORTABLE RECHARGEABLE
POWER BANK
INCLUDED

**TOUCH SCREEN
RECEPTIVE
FINGER TIP PADS**

**MULTIZONE HEATING
UP TO 6 HOURS OF HEAT**

**WATERPROOF,
WIND RESISTANT &
BREATHABLE**

MERCHANDISING

UNIVERSAL HEADLIGHT ASSEMBLY COUNTER DISPLAYS



▲ **UNIVERSAL LED PROJECTOR HEADLIGHT DISPLAYS**
TRX-133 Chrome Headlight Assembly
TRX-132 Black Headlight Assembly

DISPLAY DIMENSIONS 18" x 10" x 10.5"

TRX-132 QUALIFYING ORDER

PART NUMBER	DESCRIPTION	UNITS
TLED-H122	Universal LED Projector Headlight Assembly Black (Driver Side)	5
TLED-H123	Universal LED Projector Headlight Assembly Black (Passenger Side)	5

TRX-133 QUALIFYING ORDER

PART NUMBER	DESCRIPTION	UNITS
TLED-H120	Universal LED Projector Headlight Assembly Chrome (Driver Side)	5
TLED-H121	Universal LED Projector Headlight Assembly Chrome (Passenger Side)	5

FREIGHTLINER CASCADIA HEADLIGHT ASSEMBLY COUNTER DISPLAY



▲ **FREIGHTLINER CASCADIA LED PROJECTOR HEADLIGHT DISPLAY**
TRX-144 Chrome Headlight Assembly

DISPLAY DIMENSIONS 18" x 15" x 15"

QUALIFYING ORDER

PART NUMBER	DESCRIPTION	UNITS
TLED-H66	FTL. Cascadia LED Projector Headlight Assembly Chrome (Driver Side)	3
TLED-H67	FTL. Cascadia LED Projector Headlight Assembly Chrome (Passenger Side)	3
TLED-H68	FTL. Cascadia LED Projector Headlight Assembly Black (Driver Side)	2
TLED-H69	FTL. Cascadia LED Projector Headlight Assembly Black (Passenger Side)	2

RETRO SERIES HEADLIGHT ASSEMBLY COUNTER DISPLAY



▲ **RETRO LED PROJECTOR HEADLIGHT DISPLAY**
TRX-171 Chrome Headlight Assembly

DISPLAY DIMENSIONS 18" x 10" x 10.75"

QUALIFYING ORDER

PART NUMBER	DESCRIPTION	UNITS
TLED-H104	Retro LED Projector Headlight Assembly-Chrome (Driver Side)	3
TLED-H105	Retro LED Projector Headlight Assembly Chrome (Passenger Side)	3
TLED-H106	Retro LED Projector Headlight Assembly with Mounting Bracket - Chrome (Driver Side)	2
TLED-H107	Retro LED Projector Headlight Assembly with Mounting Bracket - Chrome (Passenger Side)	2

▲ WARNING: Cancer and Reproductive Harm - www.p65warnings.ca.gov

FREIGHTLINER CENTURY HEADLIGHT ASSEMBLY COUNTER DISPLAY



FREIGHTLINER CENTURY LED PROJECTOR HEADLIGHT DISPLAY
TRX-143 Chrome Headlight Assembly

DISPLAY DIMENSIONS 25" x 12" x 15"

QUALIFYING ORDER

PART NUMBER	DESCRIPTION	UNITS
TLED-H49	FTL. Century LED Projector Headlight Assembly Chrome (Driver Side)	2
TLED-H50	FTL. Century LED Projector Headlight Assembly Chrome (Passenger Side)	2
TLED-H57	FTL. Century LED Projector Headlight Assembly Black (Driver Side)	1
TLED-H58	FTL. Century LED Projector Headlight Assembly Black (Passenger Side)	1
TLED-H13	FTL. Century Halogen Headlight Assembly Chrome (Driver Side)	1
TLED-H14	FTL. Century Halogen Headlight Assembly Chrome (Passenger Side)	1
TLED-H15	FTL. Century Halogen Headlight Assembly Black (Driver Side)	1
TLED-H16	FTL. Century Halogen Headlight Assembly Black (Passenger Side)	1

VOLVO VN/VNL HEADLIGHT ASSEMBLY COUNTER DISPLAY



VOLVO VN/VNL LED PROJECTOR HEADLIGHT DISPLAY
TRX-131 Chrome Headlight Assembly

DISPLAY DIMENSIONS 21" x 21" x 20"

QUALIFYING ORDER

PART NUMBER	DESCRIPTION	UNITS
TLED-H17	Volvo VNL LED Projector Headlight Assembly Chrome (Driver Side)	2
TLED-H18	Volvo VNL LED Projector Headlight Assembly Chrome (Passenger Side)	2
TLED-H19	Volvo VNL LED Projector Headlight Assembly Black (Driver Side)	1
TLED-H20	Volvo VNL LED Projector Headlight Assembly Black (Passenger Side)	1
TLED-H45	Volvo VNL Halogen Headlight Assembly Chrome (Driver Side)	1
TLED-H46	Volvo VNL Halogen Headlight Assembly Chrome (Passenger Side)	1
TLED-H54	Volvo VNL Halogen Headlight Assembly Black (Driver Side)	1
TLED-H55	Volvo VNL Halogen Headlight Assembly Black (Passenger Side)	1



WARNING: Cancer and Reproductive Harm - www.p65warnings.ca.gov

MERCHANDISING

LED PROJECTOR HEADLIGHTS COUNTER DISPLAY



FRONT



SIDE

4" x 6", 5" x 7", 7" LED PROJECTOR HEADLIGHT DISPLAY
TRX-102 Counter Display

DISPLAY DIMENSIONS 18" x 8" x 14.75"

QUALIFYING ORDER

PART NUMBER	DESCRIPTION	UNITS
TLED-H6	4" x 6" LED Projector Headlight - Low Beam	16
TLED-H7	4" x 6" LED Projector Headlight - High Beam	16
TLED-H4	5" x 7" LED Projector Headlight	8
TLED-H3	7" Round LED Projector Headlight	10

LED REFLECTOR HEADLIGHTS COUNTER DISPLAY



FRONT



SIDE

4" x 6", 5" x 7", 7" LED REFLECTOR HEADLIGHT DISPLAY
TRX-121 Counter Display

DISPLAY DIMENSIONS 18" x 8" x 14.75"

QUALIFYING ORDER

PART NUMBER	DESCRIPTION	UNITS
TLED-H2	4" x 6" LED Reflector Headlight - Low Beam	16
TLED-H1	4" x 6" LED Reflector Headlight - High Beam	16
TLED-H74	5" x 7" LED Reflector Headlight	8
TLED-H77	7" Round LED Reflector Headlight	10

4" x 6" LED PROJECTOR HEADLIGHT COUNTER | SLOTWALL DISPLAY



FRONT



SIDE

4" x 6" LED PROJECTOR HEADLIGHT DISPLAY
TRX-089 Counter Display
TRX-090 Slotwall Display

DISPLAY DIMENSIONS 13.75" x 8.5" x 8"

QUALIFYING ORDER

PART NUMBER	DESCRIPTION	UNITS
TLED-H6	4" x 6" LED Projector Headlight - Low Beam	15
TLED-H7	4" x 6" LED Projector Headlight - High Beam	15

4" x 6" LED REFLECTOR HEADLIGHT COUNTER DISPLAY



FRONT



SIDE

4" x 6" LED REFLECTOR HEADLIGHT DISPLAY
TRX-122 Counter Display

DISPLAY DIMENSIONS 13.75" x 8.5" x 8"

QUALIFYING ORDER

PART NUMBER	DESCRIPTION	UNITS
TLED-H2	4" x 6" LED Reflector Headlight - Low Beam	15
TLED-H1	4" x 6" LED Reflector Headlight - High Beam	15

 WARNING: Cancer and Reproductive Harm - www.p65warnings.ca.gov



 WARNING: Cancer and Reproductive Harm - www.p65warnings.ca.gov

MERCHANDISING

STANDARD LED WORK LAMPS COUNTER DISPLAY



STANDARD WORKLAMP DISPLAY
TRX-165 Counter Display

DISPLAY DIMENSIONS 26.5" x 6" x 9"

QUALIFYING ORDER

PART NUMBER	DESCRIPTION	UNITS
TLED-U1	4.5" Round LED Work Lamp - Flood Beam	10
TLED-U9	6" Oval High Powered LED Work Lamp Spot Beam	4
TLED-U5	4.5" Square LED Work Lamp - Spot Beam	8
TLED-U32	3" Mini Square LED Work Lamp - Spot Beam	12
TLED-U34	3" Mini Round LED Work Lamp - Spot Beam	11
TLED-U4	5" Round High Powered LED Work Lamp Spot Beam	8

STELLAR SERIES MINI LED WORK LAMPS COUNTER DISPLAY



STELLAR MINI DISPLAY
TRX-134 Counter Display

DISPLAY DIMENSIONS 15" x 6" x 8"

QUALIFYING ORDER

PART NUMBER	DESCRIPTION	UNITS
TLED-U87	3" Mini Round "Stellar Series" LED Work Lamp Spot Beam	10
TLED-U88	3" Mini Round "Stellar Series" LED Work Lamp Flood Beam	6
TLED-U89	3" Mini Square "Stellar Series" LED Work Lamp Spot Beam	10
TLED-U90	3" Mini Square "Stellar Series" LED Work Lamp Flood Beam	6
TLED-U93	4" Square "Stellar Series" LED Work Lamp Spot Beam	10
TLED-U95	4.5" Round "Stellar Series" LED Work Lamp Spot Beam	10
TLED-U97	Rectangular "Stellar Series" LED Work Lamp Spot Beam	10
TLED-U98	Rectangular "Stellar Series" LED Work Lamp Flood Beam	4

STELLAR SERIES LED WORK LAMPS COUNTER DISPLAY



STELLAR SERIES DISPLAY
TRX-228 Counter Display

DISPLAY DIMENSIONS 26.5" x 6" x 9"

QUALIFYING ORDER

PART NUMBER	DESCRIPTION	UNITS
TLED-U88	3" Mini Round "Stellar Series" LED Work Lamp Flood Beam	10
TLED-U90	3" Mini Square "Stellar Series" LED Work Lamp Flood Beam	10
TLED-U94	4" Square "Stellar Series" LED Work Lamp Flood Beam	12
TLED-U96	4.5" Round "Stellar Series" LED Work Lamp Flood Beam	12

WARNING: Cancer and Reproductive Harm - www.p65warnings.ca.gov

RADIANT SERIES & STROBE LED

WORK LAMP COUNTER | FLOOR DISPLAY



PREMIUM DISPLAY
TRX-169 Floor Display

DISPLAY DIMENSIONS 27.5" x 20" x 70"

TRX-169 QUALIFYING ORDER

PART NUMBER	DESCRIPTION	UNITS
TLED-U102	4.5" Round Pair "Radiant Series" LED Work Lamp Combination Spot & Flood Beam	15
TLED-U103	4.5" Round Pair "Radiant Series" LED Work Lamp Combination Spot & Flood Beam	15
TLED-U120	4.5" Square "Radiant Series" LED Work Lamp Combination Spot & Flood Beam	10
TLED-U114	4" Round LED Work Lamp Spot Beam with Amber Strobe	5
TLED-U106	4" Cube LED Work Lamp Spot Beam with Amber Strobe	4
TLED-U105	3" Mini Rectangle LED Work Lamp Combination Spot with Flood Beam	4
TLED-W4	6" Rectangle LED Work Lamp - Spot Beam with Amber Strobe	10
TLED-U112	7" Half Moon LED Work Lamp - Flood Beam with Amber Strobe	7
TLED-U108	7" Half Moon LED Work Lamp - Flood Beam	8



COUNTER DISPLAY
TRX-170

DISPLAY DIMENSIONS 25.75" x 11" x 15.75"

TRX-170 QUALIFYING ORDER
CONTACT YOUR TRUX ACCOUNT
MANAGER TO LEARN HOW TO QUALIFY
FOR THIS DISPLAY



MERCHANDISING

STANDARD LED LIGHTING SLOTWALL DISPLAY



▲
STANDARD LED DISPLAY
TRX-094 Slotwall Display

DISPLAY DIMENSIONS 26.75" x 2" x 22.5"

DUAL LED LIGHTING SLOTWALL DISPLAY



▲
DUAL REVOLUTION LED DISPLAY
TRX-130 Slotwall Display

DISPLAY DIMENSIONS 26.75" x 2" x 22.5"

TRX-094 QUALIFYING ORDER

PART NUMBER	DESCRIPTION	UNITS
TLED-48R	4" LED Red Stop, Turn & Tail Fleet Light	16
TLED-4100R	4" LED Red Stop, Turn & Tail Light	12
TLED-OBMA	Oval Mirror LED Amber Marker Light	12
TLED-OBMR	Oval Mirror LED Red Marker Light	12
TLED-B4A	3/4" Oval LED Amber Marker Light - 3 Wires	12
TLED-B4R	3/4" Oval LED Red Marker Light - 3 Wires	12
TLED-B2A	3/4" Round LED Amber Marker Light - 2 Wires	25
TLED-B2R	3/4" Round LED Red Marker Light - 2 Wires	20
TLED-B2CR	3/4" Round LED Clear Red Marker Light - 2 Wires	20
TLED-B2CA	3/4" Round LED Clear Amber Marker Light - 2 Wires	20
TLED-2R	2" Round Ribbed LED Red Marker Light	20
TLED-2A	2" Round Ribbed LED Amber Marker Light	20
TLED-2TA	2" Round Ribbed LED Clear Amber Marker Light	16
TLED-2TR	2" Round Ribbed LED Clear Red Marker Light	8
TLED-2HA	2.5" Round Ribbed LED Amber Marker Light	12
TLED-2HR	2.5" Round Ribbed LED Red Marker Light	12
TLED-G4A	Generation 4 LED Amber Marker Light	30
TLED-G4R	Generation 4 LED Red Marker Light	6
TLED-G4CA	Generation 4 LED Clear Amber Marker Light	20
TLED-G4CR	Generation 4 LED Clear Red Marker Light	4
TLED-G2A	Generation 2 LED Amber Marker Light	16
TLED-G2R	Generation 2 LED Red Marker Light	16
TLED-INF2A	Small Infinity LED Amber Marker Light	10
TLED-INF2R	Small Infinity LED Red Marker Light	10
TLED-2X6DA	2" x 6" Multi-Directional Trailer LED Amber Marker Light	20
TLED-2X6DR	2" x 6" Multi-Directional Trailer LED Red Marker Light	10
TLED-PETA	Peterbilt LED Amber Marker Light	20
TLED-PETR	Peterbilt LED Red Marker Light	4
TLED-F45A	4.5" Slim Flatline LED Amber Marker Light	6
TLED-F45R	4.5" Slim Flatline LED Red Marker Light	5
TLED-F9A	9" Slim Flatline LED Amber LED Marker Light	6
TLED-F17A	17" Slim Flatline LED Amber Marker Light	6
TLED-F17R	17" Slim Flatline LED Red LED Marker Light	6

QUALIFYING ORDER

CONTACT YOUR TRUX ACCOUNT
MANAGER TO LEARN HOW TO QUALIFY
FOR THIS DISPLAY

▲ WARNING: Cancer and Reproductive Harm - www.p65warnings.ca.gov

3/4" STANDARD & DUAL LED LIGHTING COUNTER | SLOTWALL DISPLAY



STANDARD & DUAL LED LIGHTING DISPLAY TRX-091 Slotwall | Countertop Display

DISPLAY DIMENSIONS 26" x 5" x 3"

QUALIFYING ORDER

PART NUMBER	DESCRIPTION	UNITS
TLED-B3CA	3/4" Round LED Clear Amber Marker Light - 3 Wires	20
TLED-B3R	3/4" Round LED Red Marker Light - 3 Wires	20
TLED-BX3AG	3/4" Round LED Amber Marker to Green Auxiliary Light	20
TLED-BX3RW	3/4" Round Red Marker to White Auxiliary LED Light	20
TLED-BX4AB	3/4" Oval LED Amber Marker to Blue Auxiliary Light - 3 Wires	20
TLED-BX4AW	3/4" Oval LED Amber Marker to White Auxiliary Light - 3 Wires	20
TLED-BX4RW	3/4" Oval LED Red Marker to White Auxiliary Light - 3 Wires	20
TLED-BX4RB	3/4" Oval LED Red Marker to Blue Auxiliary Light - 3 Wires	20

DUAL REVOLUTION LED LIGHTING COUNTER DISPLAY



FRONT



SIDE

DUAL LED LIGHTING DISPLAY WITH MOTION SENSOR TRX-078 Countertop Display

DISPLAY DIMENSIONS 16.5" x 11" x 16.25"

QUALIFYING ORDER

PART NUMBER	DESCRIPTION	UNITS
TLED-4X40	4" Round Dual Revolution LED Red Stop, Turn & Tail to White Back Up Light - Grommet Mount	20
TLED-4X40F	4" Round Dual Revolution LED Red Stop, Turn & Tail to White Back Up Light - Flange Mount	6
TLED-OX60R	Oval Dual Revolution LED Red Stop, Turn & Tail to White Back Up Light	10
TLED-2XRW	2" Round Dual Revolution LED Red Stop, Turn & Tail to White Back Up Light	5
TLED-G2XRB	Generation 2 Dual Revolution LED Red Marker to Blue Auxiliary Light	12
TLED-G2XAB	Generation 2 Dual Revolution LED Amber Marker to Blue Auxiliary Light	12
TLED-G4XAB	Generation 4 Dual Revolution LED Amber Marker to Blue Auxiliary Light	20
TLED-G4XRB	Generation 4 Dual Revolution LED Red Marker to Blue Auxiliary Light	4
TLED-4XRB	4" Round Dual Revolution LED Red Stop, Turn & Tail to Blue Auxiliary Light	8



MERCHANDISING

DUAL REVOLUTION LED COUNTER DISPLAY



FRONT



SIDE

DUAL REVOLUTION LED DISPLAY TRX-092 Counter Display

DISPLAY DIMENSIONS 13" x 9" x 3"

QUALIFYING ORDER

PART NUMBER	DESCRIPTION	UNITS
TLED-4X40	4" Round Dual Revolution LED Red Stop, Turn & Tail to White Back Up Light - Grommet Mount	30
TLED-4X40F	4" Round Dual Revolution LED Red Stop, Turn & Tail to White Back Up Light - Flange Mount	7
TLED-OX60R	Oval Dual Revolution LED Red Stop, Turn & Tail to White Back Up Light	11

DUAL REVOLUTION LED SMALL SLOTWALL DISPLAY



FRONT



SIDE

DUAL REVOLUTION LED DISPLAY TRX-093 Slotwall Display

DISPLAY DIMENSIONS 13" x 3.2" x 13"

QUALIFYING ORDER

PART NUMBER	DESCRIPTION	UNITS
TLED-4X40	4" Round Dual Revolution LED Red Stop, Turn & Tail to White Back Up Light - Grommet Mount	30
TLED-4X40F	4" Round Dual Revolution LED Red Stop, Turn & Tail to White Back Up Light - Flange Mount	7
TLED-OX60R	Oval Dual Revolution LED Red Stop, Turn & Tail to White Back Up Light	11

DUAL REVOLUTION LED LARGE SLOTWALL DISPLAY



DUAL REVOLUTION LED DISPLAY TRX-079 Slotwall Display

DISPLAY DIMENSIONS 26" x 3" x 11"

QUALIFYING ORDER

PART NUMBER	DESCRIPTION	UNITS
TLED-4X40	4" Round Dual Revolution LED Red Stop, Turn & Tail to White Back Up Light - Grommet Mount	20
TLED-4X40F	4" Round Dual Revolution LED Red Stop, Turn & Tail to White Back Up Light - Flange Mount	6
TLED-OX60R	Oval Dual Revolution LED Red Stop, Turn & Tail to White Back Up Light	10
TLED-2XRW	2" Round Dual Revolution LED Red Stop, Turn & Tail to White Back Up Light	5
TLED-G2XRB	Generation 2 Dual Revolution LED Red Marker to Blue Auxiliary Light	12
TLED-G2XAB	Generation 2 Dual Revolution LED Amber Marker to Blue Auxiliary Light	12
TLED-G4XAB	Generation 4 Dual Revolution LED Amber Marker to Blue Auxiliary Light	20
TLED-G4XRB	Generation 4 Dual Revolution LED Red Marker to Blue Auxiliary Light	4
TLED-4XRB	4" Round Dual Revolution LED Red Stop, Turn & Tail to Blue Auxiliary Light	8

WARNING: Cancer and Reproductive Harm - www.p65warnings.ca.gov

DUAL & STROBE LED SMALL COUNTER DISPLAY



FRONT



SIDE

DUAL REVOLUTION STROBE LED DISPLAY
TRX-187 Counter Display

DISPLAY DIMENSIONS 13" x 7.75" x 12.75"

QUALIFYING ORDER

PART NUMBER	DESCRIPTION	UNITS
TLED-4X40	4" Round Dual Revolution LED Red Stop, Turn & Tail to White Back Up Light - Grommet Mount	20
TLED-OX60RAS	Oval Dual Revolution LED Red Stop, Turn & Tail to Amber Multi-Pulse Strobe	20

DUAL & STROBE LED SMALL SLOTWALL DISPLAY



FRONT



SIDE

DUAL REVOLUTION STROBE LED DISPLAY
TRX-186 Slotwall Display

DISPLAY DIMENSIONS 13" x 3.2" x 13"

QUALIFYING ORDER

PART NUMBER	DESCRIPTION	UNITS
TLED-4X40	4" Round Dual Revolution LED Red Stop, Turn & Tail to White Back Up Light	20
TLED-OX60RAS	Oval Dual Revolution LED Red Stop, Turn & Tail to Amber Multi-Pulse Strobe	20

EXHAUST KIT FLOOR DISPLAY



EXHAUST DISPLAY
TRX-076 Floor Display

DISPLAY DIMENSIONS 30" x 12" x 60"

QUALIFYING ORDER

**CONTACT YOUR TRUX ACCOUNT
MANAGER TO LEARN HOW TO QUALIFY
FOR THIS DISPLAY**

GLOW STRIP LED COUNTER DISPLAY



FRONT

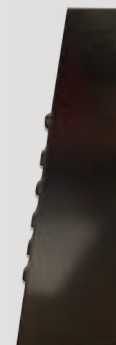

SIDE

GLOW STRIP LED DISPLAY
TRX-190 Counter Display

DISPLAY DIMENSIONS 18.25" x 5" x 15"

QUALIFYING ORDER

**CONTACT YOUR TRUX ACCOUNT
MANAGER TO LEARN HOW TO QUALIFY
FOR THIS DISPLAY**

MERCHANDISING

STARTER STAINLESS FENDER FLOOR DISPLAY

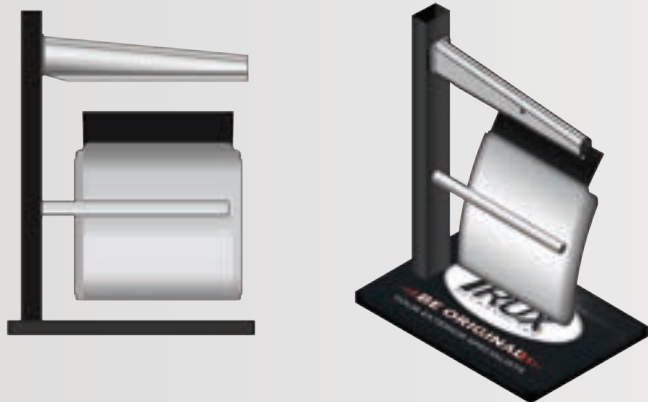

▲ QUARTER FENDER & MUDFLAP HANGER DISPLAY
TRX-168 Starter Program

DISPLAY DIMENSIONS 36" x 24" x 47"

QUALIFYING ORDER
CONTACT YOUR TRUX ACCOUNT
MANAGER TO LEARN HOW TO QUALIFY
FOR THIS DISPLAY

STANDARD STAINLESS FENDER FLOOR DISPLAY

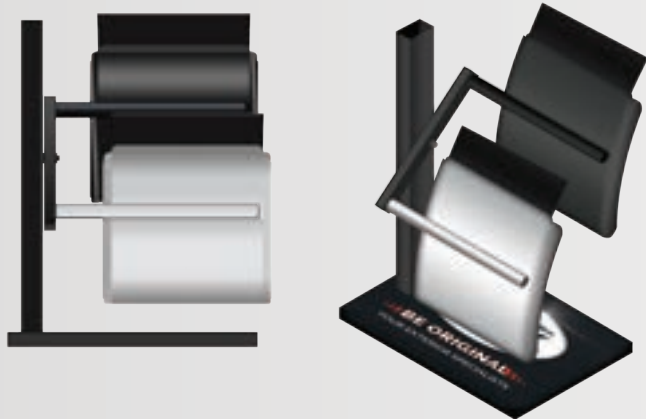

▲ QUARTER FENDER DISPLAY
TRX-167 Standard Program

DISPLAY DIMENSIONS 36" x 24" x 47"

QUALIFYING ORDER
CONTACT YOUR TRUX ACCOUNT
MANAGER TO LEARN HOW TO QUALIFY
FOR THIS DISPLAY

PREMIUM STAINLESS FENDER FLOOR DISPLAY



▲ STAINLESS QUARTER, HALF & SINGLE AXLE FENDER DISPLAY
TRX-113 Premium Program

DISPLAY DIMENSIONS 43" x 48" x 92"

QUALIFYING ORDER
CONTACT YOUR TRUX ACCOUNT
MANAGER TO LEARN HOW TO QUALIFY
FOR THIS DISPLAY

STARTER POLY FENDER FLOOR DISPLAY



▲
QUARTER FENDER DISPLAY
TRX-173 Starter Program

DISPLAY DIMENSIONS 36" x 24" x 47"

QUALIFYING ORDER
CONTACT YOUR TRUX ACCOUNT
MANAGER TO LEARN HOW TO QUALIFY
FOR THIS DISPLAY

STANDARD POLY FENDER FLOOR DISPLAY



▲
QUARTER FENDER & SINGLE AXLE DISPLAY
TRX-172 Standard Program

DISPLAY DIMENSIONS 36" x 48" x 51"

QUALIFYING ORDER
CONTACT YOUR TRUX ACCOUNT
MANAGER TO LEARN HOW TO QUALIFY
FOR THIS DISPLAY

PREMIUM POLY FENDER FLOOR DISPLAY



▲
POLY QUARTER, HALF & SINGLE AXLE FENDER DISPLAY
TRX-112 Premium Program

DISPLAY DIMENSIONS 43" x 48" x 92"

QUALIFYING ORDER
CONTACT YOUR TRUX ACCOUNT
MANAGER TO LEARN HOW TO QUALIFY
FOR THIS DISPLAY

MERCHANDISING



3/4" ROUND LED POS DISPLAYS MARKER - BOX OF 80

TRX-140
BOX CONTAINS
80 x TLED-B2A1



▲
AMBER MARKER
TRX-140 Box of 80

TRX-142
BOX CONTAINS
80 x TLED-B2R1



▲
RED MARKER
TRX-142 Box of 80

TECHNICAL SPECIFICATIONS

DOT/SAE	Compliant
DIODES	3 Diodes
FUNCTION	Marker
CURRENT DRAW	40 mA
LENS MATERIAL	Polycarbonate
SOLD	Box of 80
WARRANTY	3 Years

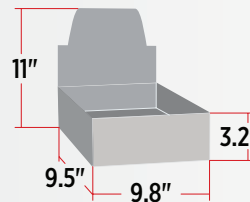
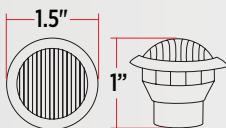

⚠ WARNING: Cancer and Reproductive Harm - www.p65warnings.ca.gov



2" ROUND LED POS DISPLAYS MARKER - BOX OF 50

TRX-223
BOX CONTAINS
50 x TLED-2A1

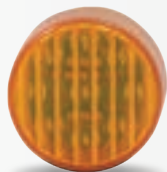

▲
AMBER MARKER
TRX-223 Box of 50



TRX-224
BOX CONTAINS
50 x TLED-2R1



▲
RED MARKER
TRX-224 Box of 50



TECHNICAL SPECIFICATIONS

DOT/SAE	Compliant
DIODES	9 Diodes
FUNCTION	Marker
CURRENT DRAW	31 mA ~ 39 mA
LENS MATERIAL	Polycarbonate
SOLD	Box of 50
WARRANTY	3 Years

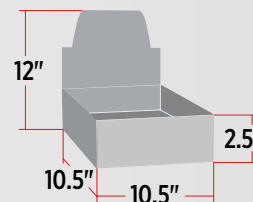
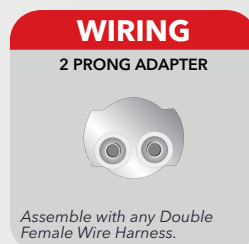
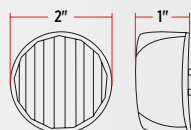

▲ **WARNING: Cancer and Reproductive Harm - www.p65warnings.ca.gov**

MERCHANDISING



2.5" ROUND LED POS DISPLAYS MARKER - BOX OF 40

TRX-235
BOX CONTAINS
40 x TLED-2HA1

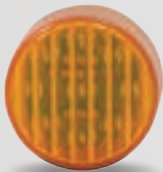

▲
AMBER MARKER
TRX-235 Box of 40

TRX-236
BOX CONTAINS
40 x TLED-2HR1



▲
RED MARKER
TRX-236 Box of 40

TECHNICAL SPECIFICATIONS

DOT/SAE	Compliant
DIODES	13 Diodes
FUNCTION	Marker
CURRENT DRAW	51 mA ~ 72 mA
LENS MATERIAL	Polycarbonate
SOLD	Box of 40
WARRANTY	3 Years

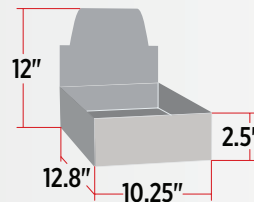
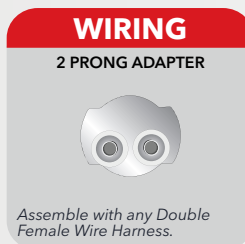
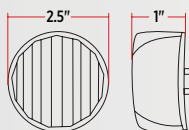

⚠️ **WARNING: Cancer and Reproductive Harm - www.p65warnings.ca.gov**



GENERATION 4 STANDARD LED POS DISPLAY MARKER - BOX OF 52

TRX-238
BOX CONTAINS
52 x TLED-G4A1



▲
AMBER MARKER
TRX-238 Box of 52



TECHNICAL SPECIFICATIONS

DOT/SAE	Compliant
DIODES	4 Diodes
FUNCTION	Marker
CURRENT DRAW	29 mA ~ 30 mA
LENS MATERIAL	Polycarbonate
SOLD	Box of 52
WARRANTY	3 Years

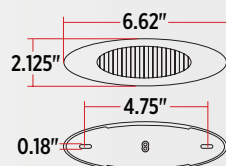

WIRING
2 BULLET PLUGS

● MARKER
● GROUND

Assemble with any standard 2 Prong Pigtail.

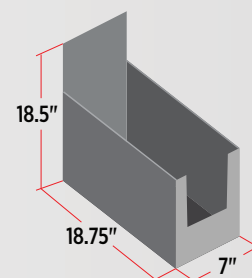

⚠ WARNING: Cancer and Reproductive Harm - www.p65warnings.ca.gov

MERCHANDISING



4" ROUND STANDARD LED POS DISPLAY STOP, TURN & TAIL - BOX OF 48

**TOP
SELLER**

TRX-136
BOX CONTAINS
48 x TLED-48R1

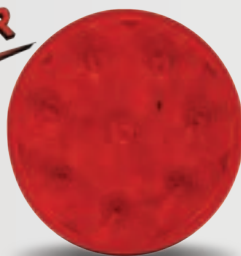

**RED STOP, TURN & TAIL
TRX-136** Box of 48



TECHNICAL SPECIFICATIONS

DOT/SAE	Compliant
DIODES	8 Diodes
FUNCTION	Stop, Turn & Tail
CURRENT DRAW	130 mA
LENS MATERIAL	Polycarbonate
SOLD	Box of 48
WARRANTY	3 Years

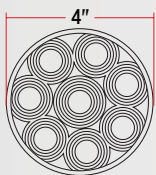

WIRING

3 PRONG ADAPTER



Assemble with any Triple Female Wire Harness.

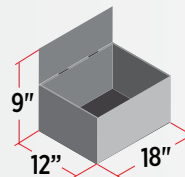

WARNING: Cancer and Reproductive Harm - www.p65warnings.ca.gov



4" ROUND DUAL REVOLUTION LED POS DISPLAY

STOP, TURN & TAIL TO WHITE BACK UP - BOX OF 24

TOP SELLER

TRX-237
BOX CONTAINS
24 x TLED-4X401



▲ **RED STOP, TURN & TAIL TO WHITE BACK UP**
TRX-237 Box of 24



TECHNICAL SPECIFICATIONS

DOT/SAE	Compliant to Auxiliary
DIODES	19 Diodes
FUNCTION 1	Stop, Turn & Tail
FUNCTION 2	Back Up
CURRENT DRAW FUNCTION 1	270 mA
CURRENT DRAW FUNCTION 2	220 mA
LENS MATERIAL	Polycarbonate
SOLD	Box of 24
WARRANTY	3 Years

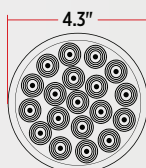

WIRING

3 PRONG & BULLET PLUG



S, T & T



BACK UP

Assemble with any standard 3 Prong Pigtail and single Female Harness.

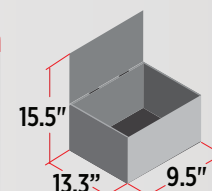

⚠ WARNING: Cancer and Reproductive Harm - www.p65warnings.ca.gov

MERCHANDISING



2" MINI HIGH POWERED LED WORK LAMP POS DISPLAY SPOT BEAM - BOX OF 30

TRX-135
BOX CONTAINS
30 x TLED-U104



SPOT BEAM
TRX-135 Box of 30



TECHNICAL SPECIFICATIONS

RAW LUMENS	1500 Lumens
EFFECTIVE LUMENS	900 Lumens
BEAM PATTERN	Spot Beam
DIODES	9 Diodes
OPERATING VOLTAGE	12-24 Volts
LED POWER	18 Watts
CURRENT DRAW (A)	0.87 Amp @ 12 Volts
COLOR TEMPERATURE	6500 Kelvin
HOUSING MATERIAL	Aluminum Die Cast
BRACKET MATERIAL	Stainless Steel
LENS MATERIAL	Polycarbonate
WATERPROOF RATING	IP67 Rating
SOLD	Box of 30
WARRANTY	3 Years

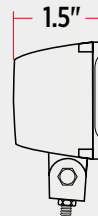
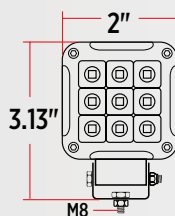

BEAM PATTERN

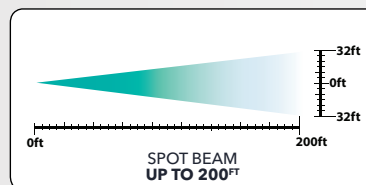

WIRING

2 WIRE CONNECTION



Connect the negative and positive work lamp wires to the corresponding negative and positive wires from the truck's wiring harness.

1500
LUMENS

SPOT
BEAM

SOLD IN A BOX
30 PCS

WARNING: Cancer and Reproductive Harm - www.p65warnings.ca.gov



6" RECTANGLE LED WORK LAMP POS DISPLAY

FLOOD BEAM - BOX OF 21

TRX-239
BOX CONTAINS
21 x TLED-U122



▲ SPOT BEAM
TRX-239 Box of 21



TECHNICAL SPECIFICATIONS

RAW LUMENS	1100 Lumens
EFFECTIVE LUMENS	750 Lumens
BEAM PATTERN	Spot Beam
DIODES	12 Diodes
OPERATING VOLTAGE	9-30 Volts
LED POWER	18 Watts
CURRENT DRAW (A)	1.5 Amp @ 12 Volts
COLOR TEMPERATURE	6000 Kelvin
HOUSING MATERIAL	Aluminum Die Cast
BRACKET MATERIAL	Stainless Steel
LENS MATERIAL	Polycarbonate
WATERPROOF RATING	IP67 Rating
SOLD	Box of 21
WARRANTY	3 Years

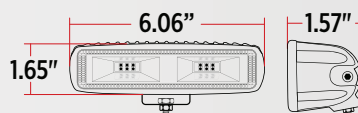

BEAM PATTERN

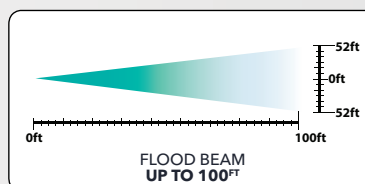

WIRING

2 WIRE CONNECTION



Connect the negative and positive work lamp wires to the corresponding negative and positive wires from the truck's wiring harness.

1100
LUMENS

FLOOD
BEAM

SOLD IN A BOX
21 PCS

⚠️ WARNING: Cancer and Reproductive Harm - www.p65warnings.ca.gov

MERCHANDISING



4" X 6" HEATED LED PROJECTOR HEADLIGHT POS DISPLAYS HIGH OR LOW BEAM - BOX OF 12 OR 6

TRX-240
BOX CONTAINS
6 x TLED-H11



HIGH BEAM
TRX-240 Box of 6

TECHNICAL SPECIFICATIONS

LED POWER (W)	27 Watts
RAW LUMENS	Low: 1300 Lumens High: 2400 Lumens
EFFECTIVE LUMENS	Low: 850 Lumens High 1150 Lumens
BEAM PATTERN	TLED-H12: Low Beam TLED-H11: High Beam
OPERATING VOLTAGE	9-24 Volts (DRL Compatible)
CURRENT DRAW (A)	2.3 Amps @ 12 Volts
COLOR TEMPERATURE	6000 Kelvin
INTERIOR	Chrome
HOUSING MATERIAL	Aluminum Alloy
LENS MATERIAL	Polycarbonate
WATERPROOF RATING	IP67 Rating
COMPLIANCE	DOT SAE FMVSS-108 CMVSS-108
SOLD	TRX-240: Box of 6 TRX-241: Box of 12
WARRANTY	7 Years

TRX-241
BOX CONTAINS
12 x TLED-H12



LOW BEAM
TRX-241 Box of 12

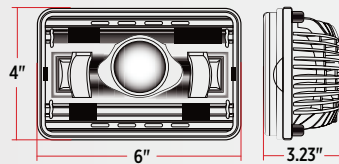

RETROFIT

LOW BEAM

- 4652
- H4652
- H4656
- H4662

HIGH BEAM

- H4739
- H5062
- H4651
- H5051

BEAM PATTERNS

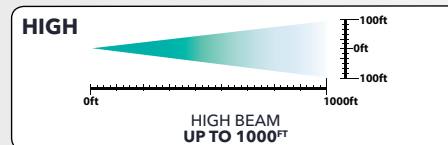
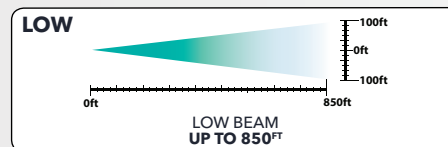

DOT
COMPLIANT

LOW BEAM
1300
LUMENS

HIGH BEAM
2400
LUMENS

WIRING

HIGH BEAM H4 CONNECTOR
(2 Wires)

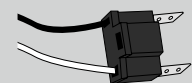

LOW BEAM H4 CONNECTOR
(3 Wires)



Plug & Play

WARNING: Cancer and Reproductive Harm - www.p65warnings.ca.gov

SHOW TRUCK POSTERS

24" WIDE x 18" HIGH



▲ "CODE BLUE" - 2019 SHOW TRUCK
TRX-178 Kenworth W900L



▲ "PURPLE HAZE" - 2018 SHOW TRUCK
TRX-157 Peterbilt 379



▲ "THE GENERAL" - 2017 SHOW TRUCK
TRX-158 Kenworth T660



▲ "MIDNIGHT EXPRESS" - 2016 SHOW TRUCK
TRX-159 Volvo VN670



▲ "WICKED" - 2015 SHOW TRUCK
TRX-160 Kenworth W900L

TECHNICAL SPECIFICATIONS

MATERIAL	Poster Paper
SOLD	Individually

TRUX CATALOG

VOLUME 11

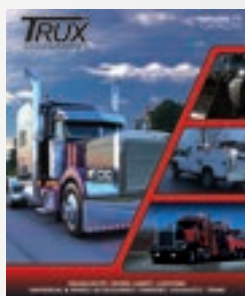

▲ VOLUME 11
TRX-100

TECHNICAL SPECIFICATIONS

SOLD	Individually
------	--------------

TRUX NATION

MAGAZINE



▲ TRUX NATION
TRX-191

TECHNICAL SPECIFICATIONS

SOLD	Individually
------	--------------

MERCHANDISING

TRUX USB KEY MARKETING RESOURCES



▲
16GB
TRX-105

USB INCLUDES	Product Technical Data Website Product Images Product Videos Product Installation Instructions Catalogs & Magazines
--------------	---------------------------------------------------------------------------------------------------------------------------------

TRUX LOGO SIGN

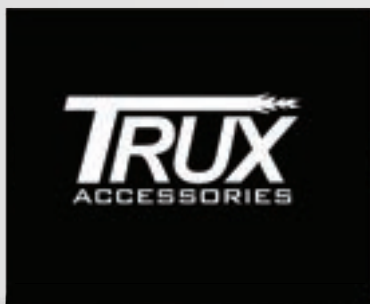

▲
CHOROPLAST SIGN
TRX-072

TECHNICAL SPECIFICATIONS

MATERIAL	Choroplast
SOLD	Individually

TRUX LOGO SIGN 31" WIDE x 9" HIGH



▲
HALF MOON
TRX-014

TECHNICAL SPECIFICATIONS

MATERIAL	Choroplast
SOLD	Individually

TRUX MINI BATTERY PACK 8 x AA BATTERIES

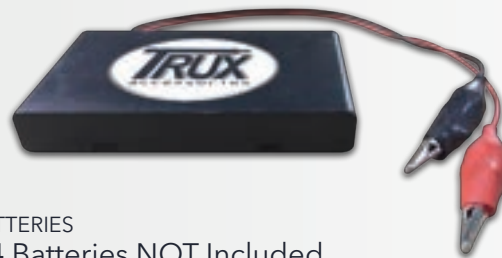

▲
FOR AA BATTERIES
TRX-054 Batteries NOT Included

TECHNICAL SPECIFICATIONS

SOLD	Individually
------	--------------

TRUX BANNER 35" WIDE x 21" HIGH



▲
GROMMET MOUNT
TRX-012

TECHNICAL SPECIFICATIONS

MATERIAL	Vinyl with Grommets
SOLD	Individually

RESTOCK TICKET HANGER STYLE



▲
5" WIDE x 7" HIGH
TRX-209

TECHNICAL SPECIFICATIONS

DIMENSIONS	5" x 7"
MATERIAL	Card
SOLD	Individually

▲ WARNING: Cancer and Reproductive Harm - www.p65warnings.ca.gov

SLOTWALL PANELS

BLACK SLOTTED WOOD

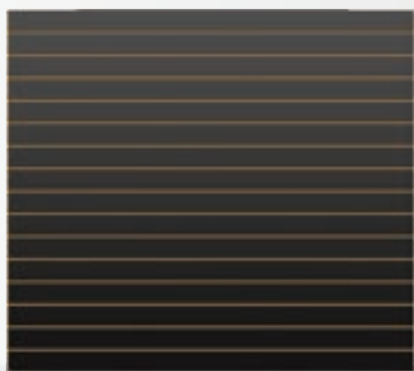

▲
4 FT LONG x 4 FT HIGH
TRX-200

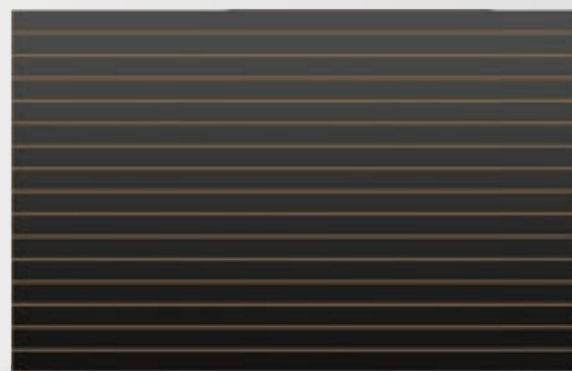

▲
8 FT LONG x 4 FT HIGH
TRX-201

TECHNICAL SPECIFICATIONS

MATERIAL	Wood
SOLD	Individually

SLOTWALL PANEL ACCESSORIES

HOOK | LITERATURE HANGING HOLDER | BRACKET | BASKET



▲
STANDARD SLOTWALL HOOK
TRX-202 4" Long
TRX-203 8" Long
TRX-204 10" Long
TRX-205 12" Long

TECHNICAL SPECIFICATIONS

SOLD	Individually
------	--------------



▲
KNIFE BRACKET
TRX-214 12" Long

TECHNICAL SPECIFICATIONS

SOLD	Individually
------	--------------



▲
6 BALL WATERFALL HOOK
TRX-206

TECHNICAL SPECIFICATIONS

SOLD	Individually
------	--------------



▲
BLACK SHELVES
TRX-233 48" Long x 12" Depth
TRX-234 24" Long x 12" Depth

TECHNICAL SPECIFICATIONS

MATERIAL	Laminated Melamine
SOLD	Individually



▲
LITERATURE HANGING HOLDER
TRX-029 For 8.5" x 11" Brochures

TECHNICAL SPECIFICATIONS

DIMENSIONS	9" x 1.75" x 10"
MATERIAL	Plastic
SOLD	Individually



▲
BASKET
TRX-208 For All Purpose Products

TECHNICAL SPECIFICATIONS

DIMENSIONS	12" x 12" x 8"
MATERIAL	Black Metal
SOLD	Individually

MERCHANDISING

COUNTER MATS 19.5" WIDE x 15.75" HIGH



▲
TRUX LATEST
TRX-244



▲
PROJECTOR LED HEADLIGHT SERIES
TRX-245



▲
UNIVERSAL ACCESSORIES
TRX-246

TECHNICAL SPECIFICATIONS

SOLD	Individually
------	--------------

PRODUCT DISPLAY SIGNS 30" WIDE x 8" HIGH | SLOTWALL & MOBILE RETAIL DISPLAYS



▲
STANDARD LED LIGHTING
TRX-067



▲
UNIVERSAL ACCESSORIES
TRX-068



▲
LED WORK LAMPS
TRX-071



▲
DUAL REVOLUTION LED LIGHTING
TRX-084



▲
LED HEADLIGHTS
TRX-103



▲
WHEEL ACCESSORIES
TRX-070

TECHNICAL SPECIFICATIONS

DIMENSIONS	30" x 0.25" x 8"
MATERIAL	Coroplast
SOLD	Individually

▲ WARNING: Cancer and Reproductive Harm - www.p65warnings.ca.gov

MOBILE RETAIL DISPLAYS

CUSTOMIZABLE



32" LONG x 32" WIDE x 80" HIGH
TRX-063 Custom

WANT TO SHOWCASE ALL YOUR ACCESSORIES BUT HAVE LIMITED SPACE?

Why not ask your Trux Account Manager to design a completely customized mobile solution that BEST FITS YOUR NEEDS!

Our Mobile Solution only takes 32" x 32" of floor space BUT it provides 60 SQUARE FEET OF PRODUCT!!

Below are just some of the solutions Trux has designed to help grow our customers' business. Call your Trux Account Manager today to get started on your very own customized MRD Display!



EXAMPLE LED LIGHTING DISPLAY



EXAMPLE LED HEADLIGHTS & WORKLAMPS DISPLAY



EXAMPLE WHEEL ACCESSORIES DISPLAY



EXAMPLE MUDFLAP HANGERS DISPLAY

WARNING: Cancer and Reproductive Harm - www.p65warnings.ca.gov

MERCHANDISING

GONDOLA DISPLAYS CUSTOMIZABLE



OPTIMIZE & INCREASE YOUR SALES

Trux Gondolas allow for the versatility to carry many Trux products from displaying accessories on hooks to wire baskets and shelves, the options are endless in displaying our range of accessories.

Increase your sales and optimize your retail space with Trux four-sided free-standing display by creating aisles of product and increasing exposure.

Arriving to your store pre-assembled these Gondola Displays are custom to your requirements. Call your Trux Account Manager today to get started on your very own customized Gondola Display!



 WARNING: Cancer and Reproductive Harm - www.p65warnings.ca.gov

SLOTWALL DISPLAYS

CUSTOMIZABLE



MAXIMIZE ANY WALL OR GONDOLA IN YOUR SHOW ROOM WITH ONE OF OUR CUSTOM DISPLAYS

THE PROCESS

We will customize your display from the answers and measurements received from the questionnaire that we have provided. From there Trux will build a product diagram and a suggested order for you to approve.



 WARNING: Cancer and Reproductive Harm - www.p65warnings.ca.gov

MERCHANDISING

SLOTWALL DISPLAYS CUSTOMIZABLE



**DEPENDING ON THE SIZE OF
THE DISPLAY, FREE TRUX
BANNERS CAN BE ADDED!**

CALL YOUR TRUX ACCOUNT MANAGER
AT 1-888-950-2227
FOR MORE INFORMATION.

 WARNING: Cancer and Reproductive Harm - www.p65warnings.ca.gov

GENERAL POLICY - WARRANTIES

For Owner-Operators, all warranty/return claims must be requested through our authorized Trux Accessories Distributor. Trux Accessories will only process claims from an authorized Trux Distributor. For more information on the warranty/return policy, please contact your Trux Distributor.

WARRANTY COVERAGE

Trux Accessories reserves the right to request digital pictures or warranties to be returned to Trux for verification. In addition, Trux Accessories is not responsible for any damage caused by accidents, road hazards, non-standard application or misuse. Do not discard warranty items until authorized by a Trux Accessories Representative.

To acquire a Warranty Request Form, please contact our Customer Service Representatives at 1-888-950-2227.

LED HEADLIGHTS

All LED Headlights have the following warranty coverage from date of purchase:

- Projector LED - 7 Years
- Reflector LED - 5 Years
- Off-Road LED - 1 Year
- LED Headlight Assemblies - 3 Years

(Exception: Freightliner Century & Volvo LED Projector & Halogen Headlight Assemblies have the following warranty coverage - 2 years on LEDs only)

Trux Accessories will replace any LED with one or more burnt-out diode during its guaranteed time period. Warranties do not apply to any LED light that has been installed incorrectly (this includes over-torquing of screws). Condensation is not warranted if all diodes are functioning properly.

LED LIGHTING & LED WORK LAMPS

- All standard LED Lights & Work Lamps have a 3 Year Warranty from date of purchase.

Trux Accessories will replace any LED with one or more burnt-out diode during its guaranteed time period. Warranties do not apply to any LED light that has been installed incorrectly (this includes over-torquing of screws). Condensation is not warranted if all diodes are functioning properly.

STAINLESS STEEL & UNIVERSAL ACCESSORIES

- Products are guaranteed against defective workmanship for 1 Year from date of purchase.
- Trux Accessories does not warranty items that have failed due to driver error.
- Trux Accessories does not warranty items that have been modified (including painting the product).
- Trux Accessories does not warranty items that have failed due to improper installation.
- Trux Accessories does not warranty items that have been used in a "non-standard application".

REDEEMING YOUR WARRANTIES

1. Fill out and fax a copy of the "Product Warranty Request Form" to Trux with pictures of warranty items.
2. For LEDs, batch numbers are required for authentication (this code is found on the back of the light).
3. For Stainless items, Fenders and Stacks, please e-mail required pictures of the item to your Trux Account Manager.
4. If request is approved, we will contact you with a choice of redeeming warranties with replacement parts, or a credit note.

U.S. RMA FORM

CANADA RMA FORM

WARRANTY REQUEST FORMS

For more information on acquiring RMA forms, contact the Trux Customer Service Representatives at 1-888-950-2227.

POLICIES

SHIPPING POLICIES

Proper PO's are required for all orders. If you cannot provide a proper PO, proof of order must be submitted by e-mail or fax.

FREE SHIPPING

FOR SMALL PRODUCTS: **\$1000.00 Mixed**

- Lights
- Light Accessories
- Interior Accessories
- Small Exterior Accents

PRODUCT CATEGORIES

Product categories are defined between parcel and pallet size shipments.

You can mix any Trux Accessories product of your choice for free shipping as long as the products fall into one of the categories mentioned above. Order will be shipped via UPS.

FOR LARGE PRODUCTS: **\$3000.00 Mixed (US) | \$4000.00 Mixed (Canada)**

- Sunvisors
- Exterior Accessories
- Wheel Accessories
- Center Panels
- Mud flap Hangers
- Train Horns

You can mix any Trux Accessories products of your choice for free shipping including all previously mentioned categories of "Free shipping for Small Products". Order will be shipped by pallet via a national carrier.

DROP SHIPMENTS

We are pleased to drop ship your order anywhere within the Continental USA and Canada. Please be aware that additional fees may apply to shipments going to a residential address. Drop shipment orders must be submitted by email or fax. Drop ships must have a valid street address, we cannot ship to post office boxes.



GENERAL POLICY - RETURNS

Trux Accessories will accept returns of products with valid reason, as determined by your Trux Representative. All returns must be authorized by your Trux Representative before shipment is returned.

REQUESTING AN RMA

All RMA requests must be submitted by [FAX \(450-622-2507\)](tel:450-622-2507) or by [EMAIL](mailto:customerservice@truxaccessories.com) to your Trux representative or a member of our Customer Service Team (customerservice@truxaccessories.com).

Send a completed copy of the Return of Merchandise Authorization (RMA) form. All returned items must have a RMA number, each box must be labeled with this number. If boxes are not labeled, shipment may be refused at our warehouse location, resulting in a delay in the credit or no credit issued.

VALID REASON FOR RETURNS

- If product hasn't moved in 6-12 months, Trux Accessories will accept return of products provided that an offsetting order of equal dollar amount is placed. If no offsetting order is placed, a 20% restocking fee will apply.
- If the wrong product was ordered by the distributor - 20% restocking fee.
- If the wrong product was shipped by Trux - No restocking fee.
- If the Distributor receives an over-shipment of product from Trux - No restocking fee.
- If product was received damaged - No restocking fee (provided damages were reported within 48 hours of receipt) - (Proof of damage required with digital images)

PLEASE NOTE

- For returns of Trux installation items, a 20% restocking fee will apply.
- If customer pricing labels are present on returned products; 35% restocking fee or refusal of return.
- Shipping costs to return items is covered by the customer unless otherwise stated by your Trux Representative or Customer Service Team Member.
- If a product is not returned within 60 days of request - RMA will be considered outstanding and will be closed.

Trux Accessories cannot guarantee a full credit for any item that is returned incomplete or damaged. For all returns, it is the responsibility of the distributor to ship the product back with proper packaging to avoid damages while in transit. Failure to do so risks a partial or zero credit.

Returns are processed in the form of company credit. Company credit is valid for 1 year from issuing date. Trux Accessories does not issue refund checks for returns. Credits will be processed within 30 days of return.

Trux Accessories reserves the right to decline any return request
***RMA / WARRANTY policies are subject to change**

POLICIES

SHIPPING POLICIES

MULTIPLE BRANCH SHIPMENTS

Want to combine orders from all your company branches to receive free shipping? **We Can Do That!**

1. Send in separate orders with the name of the city/branch clearly marked
2. Each box will be labeled by Trux Accessories accordingly
3. Orders will ship to one main location of your choice
4. Once at your desired location, pallet can be broken down and then shipped to each branch using your internal shipping methods

DAMAGED SHIPMENTS

In the unforeseen event that you receive a shipment from Trux Accessories that looks damaged, please follow these steps for a quick replacement.

1. Sign receipt of shipment as damaged, mark "DAMAGED" on all delivery paperwork
2. Please do not disassemble pallet, take multiple and clear pictures of damages and send via email to Trux Customer Service Representative (customerservice@truxaccessories.com)
3. Contact your Trux Customer Service Representative immediately: 1-888-950-2227
4. Do not discard any items unless authorized by your Trux Customer Service Representative

Failure to notify Trux Accessories of damages within 48 hours of receipt absolves Trux Accessories of any responsibility for replacement or credit.



LED HEADLIGHTS & ASSEMBLIES

TRUX PART #	UNITED PACIFIC PART #	GROTE PART #	MAXXIMA PART #	JW SPEAKER PART #	PETERSON PART #	TRUCKLITE PART #	OPTRONICS PART #	GRAND GENERAL PART #	DOUBLE JJ ENTERPRISES PART #
TLED-H1	31397	94411-5	VHL-4X6HI MHL-4X6HI MHLE-4X6HI	-	703C	27654C	-	-	-
TLED-H2	31396	94421-5	VHL-4X6LO MHL-4X6LL MHLE-4X6LO	-	702C	27640C	-	-	-
TLED-H3	31496		VHL-07DRL	554961	701C	27270C	HLL93HLS		
TLED-H4	34122	90951-5	VHL-5X7DRL	550071	-	27450C	-	-	-
TLED-H5	34123	-	-	-	-	-	-	-	-
TLED-H6	31274	94421-5	VHL-4X6DRL	551371	-	-	HLL78LS	-	-
TLED-H7	31275	94411-5	-	551381	-	-	HLL79HS	-	-
TLED-H11	-	-	-	551781	-	-	-	-	-
TLED-H12	-	-	-	551771	-	-	-	-	-
TLED-H13	31203	-	-	-	-	-	-	-	-
TLED-H14	31204	-	-	-	-	-	-	-	-
TLED-H15	31205	-	-	-	-	-	-	-	-
TLED-H16	31206	-	-	-	-	-	-	-	-
TLED-H17	31445	-	-	-	-	-	-	-	-
TLED-H18	31446	-	-	-	-	-	-	-	-
TLED-H19	35789	-	-	-	-	-	-	-	-
TLED-H20	35789	-	-	-	-	-	-	-	-
TLED-H45	31263	-	-	-	-	-	-	-	-
TLED-H46	31264	-	-	-	-	-	-	-	-
TLED-H51	31285	-	-	-	-	-	-	-	-
TLED-H52	31297	-	-	-	-	-	-	-	-
TLED-H54	31268	-	-	-	-	-	-	-	-
TLED-H55	31269	-	-	-	-	-	-	-	-
TLED-H71	34124	-	-	-	-	-	-	-	-
TLED-H73	-	-	-	552651	-	-	-	-	-
TLED-H74	-	90951-5	VHL-5X7HILO MHL-5X7HILO	-	-	-	-	-	-
TLED-H75	-	-	-	552671	-	-	-	-	-
TLED-H77	-	90941-5	VHL-07HILO MHL-07HILO	-	-	-	-	-	-
TLED-H120	31154	-	-	-	-	-	-	-	-
TLED-H121	31155	-	-	-	-	-	-	-	-
TLED-H122	31156	-	-	-	-	-	-	-	-
TLED-H123	31157	-	-	-	-	-	-	-	-
TU-1045	30438								80432

TRUX INTERCHANGE

LED WORK LAMPS

TRUX PART #	UNITED PACIFIC PART #	GROTE PART #	MAXXIMA PART #	JW SPEAKER PART #	PETERSON PART #	TRUCKLITE PART #	OPTRONICS PART #	GRAND GENERAL PART #	DOUBLE JJ ENTERPRISES PART #
TLED-U1	39688	-	MWL-01B MWL-28 MWL-41	-	-	81240	-	76350 80417	-
TLED-U2		-	MWL-27	-	-	-	-	-	-
TLED-U4	36617	-	MWL-01HP	-	-	-	-	-	-
TLED-U5	37553	-	-	-	-	-	-	-	-
TLED-U6	37088	-	-	-	-	-	-	-	-
TLED-U8	-	63J01	MWL-24SP	-	-	-	-	-	-
TLED-U9	-	63J01	-	-	-	-	-	-	-
TLED-U16	37561B	-	M42347	-	-	-	-	-	-
TLED-U17		-	M63347	-	-	-	-	-	-
TLED-U18	36854	63F61 63F71	-	-	-	-	-	-	-
TLED-U20	-	-	MWL-04 MWL-26-A	-	-	-	-	-	-
TLED-U22	36508	63621 63611	MWL-05SP MWL-07SP MWL-29 MWL-39 MWL-42 MWL-50SP MWL-57SP MWL-58	-	-	-	-	-	-
TLED-U25	-	-	MWL-01HP MWL-19-A	-	-	-	-	-	-
TLED-U26	-	-	MWL-27-A MWL-30 MWL-40	-	-	-	-	-	-
TLED-U27	37622	62L81 63F71	MWL-16 MWL-43	-	-	-	-	-	-
TLED-U29		63F91 63J11	MWL-25SP	-	-	-	-	76364	-
TLED-U32	37622		MWL-20 MWL-20FB	-	-	-	-	-	-
TLED-U33	37157	64H01-5	MWL-20 MWL-20FB	-	-	8192	-	-	-
TLED-U34	37074	64G41 64G61	-	-	-	-	-	-	-
TLED-U35	-	64G51 64G71	-	-	-	-	-	-	-
TLED-U36	-	BZ301-5	PLB-640	-	-	-	-	-	-
TLED-U40	-	63601	MWL-05SP	-	-	-	-	-	-
TLED-U47	-	63821 63831	MWL-12	-	-	-	-	-	-
TLED-U66	-	64J21	-	-	-	-	-	-	-
TLED-U67	-	64J31	-	-	-	-	-	-	-

CONTINUED ON NEXT PAGE

TRUX PART #	UNITED PACIFIC PART #	GROTE PART #	MAXXIMA PART #	JW SPEAKER PART #	PETERSON PART #	TRUCKLITE PART #	OPTRONICS PART #	GRAND GENERAL PART #	DOUBLE JJ ENTERPRISES PART #
TLED-U86	36641	-	-	-	-	-	-	-	-
TLED-U87	-	64G01 64S51	-	-	-	-	-	-	-
TLED-U88	-	64G11 64S61 BZ111-5	-	-	-	-	-	-	-
TLED-U90	-	BZ601-5	-	-	-	-	-	-	-
TLED-U93	37598	63981	-	-	-	-	-	-	-
TLED-U94	37597	63991 BZ201-5	-	-	-	-	-	-	-
TLED-U96	-	BZ101-5	MWL-11HL	-	-	-	-	-	-
TLED-U98	-	BZ301-5	-	-	-	-	-	-	-

LED LIGHTING & ACCESSORIES

TRUX PART #	UNITED PACIFIC PART #	GROTE PART #	MAXXIMA PART #	TRUCKLITE PART #	OPTRONICS PART #	GRAND GENERAL PART #	ROADMASTER PART #
B608	-	-	M50950A-200	-	-	-	1990
B611	-	-	M50950A-100	-	-	-	1991
B612	34243	-	M50900 -100	-	-	-	1992
D612	34197	-	M50960-100 M50960-50	-	-	-	-
TB-C7W	39930	60261 60691 G6151	-	-	-	-	-
TB-F2A	-	L105116037	-	-	-	-	-
TB-F2B	-	L105116047	-	-	-	-	-
TB-F2G	-	L105116057	-	-	-	-	-
TB-F2R	-	L105116027	-	-	-	-	-
TB-F2W	-	L105116017	-	-	-	-	-
TB-S1156A	-	94793-4	-	-	-	-	-
TB-S1156W	-	94791-4 94801-5	-	-	-	-	-
TB-S1157R	-	94812-4	-	-	-	-	-
TB-S1157W	-	94811-4 94821-5	-	-	-	-	-
TB-SP3037A	37800 38272	94753-4	-	-	-	-	-
TB-SP3037B	38273 37801	-	-	-	-	-	-
TB-SP3037G	38274	-	-	-	-	-	-
TB-SP3037R	37802 38276	94752-4	-	-	-	-	-
TB-SP3037W	37803 38277	94761-5	-	-	-	-	-

CONTINUED ON NEXT PAGE

TRUX INTERCHANGE

LED LIGHTING & ACCESSORIES

TRUX PART #	UNITED PACIFIC PART #	GROTE PART #	MAXXIMA PART #	TRUCKLITE PART #	OPTRONICS PART #	GRAND GENERAL PART #	ROADMASTER PART #
TB-SP3156W	-	94831-4 94841-5	-	-	-	-	-
TB-SP3157A	-	94853-4 94860-5	-	-	-	-	-
TB-SP3157R	-	94852-4	-	-	-	-	-
TB-SP3157W	-	94851-4 94860-5 94861-5	-	-	-	-	-
TBEZ-2CH3	10458 20501	-	M50305	-	-	80729	-
TBEZ-2CH4	33996	-	-	-	-	-	-
TBEZ-2HCH2	-	-	-	-	-	80726	802PV
TBEZ-2HCH3	20503	-	M50105	-	-	-	-
TBEZ-4CH3	10484 10500 20504	-	M50405	-	-	-	-
TBEZ-4CH4	33998	-	-	-	-	-	-
TBEZ-4LR	-	43253	M43253 M50410	-	-	87143	-
TBEZ-OBCH3	20506	-	M50146 M50605	-	-	-	-
TBEZ-OBCH4	-	-	M63253CH	-	-	-	-
TBEZ-OLR	-	43723	-	-	-	87146	-
TBEZ-SQR	10485	-	M49705	-	-	-	808PV
TGRO-2HR	-	92070	M50102	10702	-	-	-
TGRO-2HRO	-	91400 91410	M50100-B	-	-	-	1817-2
TGRO-2R	-	92120 GRM4320B-PG	M50300-B	-	-	80722	1817
TGRO-2RC	-	92150 GRM4300B-PG	-	-	-	-	-
TGRO-4R	-	91740	M50400-B	-	-	80473	1913-2
TGRO-4RC	-	91950	-	-	-	-	-
TGRO-OBR	-	92420 GRM4310B-PG	M50600 -B M50607	-	-	80802	1917-2
TGRO-OBRC	-	92720	M50606-X	-	-	-	-
TGRO-SQR	-	-	M49700	-	-	-	1921-2
TLED-1X2A	-	47083 G1503 MKR4700Y-PG	M20320Y	-	-	-	1831A
TLED-1X2R	-	47082 G1502 MKR4700R-PG	M20320R	-	-	-	1831R
TLED-1X4A	-	47093 47493 G1903 MKR4710Y-PG	M20350Y	-	-	-	1829A
TLED-1X4R	-	46742 47092 47492 G1902 MKR4710R-PG	M20350R	-	-	-	1829R

CONTINUED ON NEXT PAGE

TRUX PART #	UNITED PACIFIC PART #	GROTE PART #	MAXXIMA PART #	TRUCKLITE PART #	OPTRONICS PART #	GRAND GENERAL PART #	ROADMASTER PART #
TLED-2A	38170	47113 G3003	M09100Y	10385Y 3050-A	MCL50ABP	79280	1815-1A
TLED-2BA	-	47213 G3093	M09105Y M34600Y	-	-	-	1821-1A
TLED-2BR	-	47212 G3092	M09105R M34600R	-	-	-	1821-1R
TLED-2HA	-	45833-3 47123 G1033 G1093	M11300Y	10275Y	-	-	1824-1A
TLED-2HBA	-	47223 G1083	M11201Y M16800Y	-	-	-	1825-1A
TLED-2HBR	-	47222 G1082	M11201R M16800R	-	-	-	1825-1R
TLED-2HR	38177	45832-3 47122 G1032 G1092	M11300R M16280R	-	-	-	1824-1R
TLED-2HTA	-	G1043	M11300YCL	1051A	-	-	1824-2AC
TLED-2HTR	-	G1042	M11300RCL	1051	-	-	1824-2RC
TLED-2HXCA	-	-	-	1051A	-	-	-
TLED-2HXCR	-	-	-	1051	-	-	-
TLED-2R		45822 47112 G3002	M09100R	-	-	-	1815-1R
TLED-2TA	38362	-	M09100YCL	-	-	-	1815-2AC
TLED-2TR		-	M09100RCL	-	-	-	1815-2RC
TLED-2X6A	38256	-	M20395Y	21275Y		77664	1840-1A
TLED-2X6R	38257	-	M20395R				1840-1R
TLED-2X6RA	-	46073 46833 47073 47163 47733 G2103	M20330Y M20391Y	-	-	-	1842A
TLED-2X6RR	-	47072 47162 47732 G2102	M20330R M20391R	-	-	-	1842R
TLED-2X6SA	38578	-	M63120Y	-	-	-	-
TLED-2X6SCA	38579	-		-	-	-	-
TLED-2XCA	-	-	M34260YCL	-	-	-	-
TLED-2XCR	-	-	M34260RCL	-	-	-	-
TLED-4100A	-	53253 53413 53553 54313 54333 54343 54363 54643 G4003	M42100Y	-	-	76450	-
TLED-4100R	39821	-	-	44253R 4050	STL55RBP	76457 76452	-
TLED-4100W	36680 38065	62101 62271 62391 62691	M42324	4060C	-	76454	1916-1W

CONTINUED ON NEXT PAGE

TRUX INTERCHANGE

LED LIGHTING & ACCESSORIES

TRUX PART #	UNITED PACIFIC PART #	GROTE PART #	MAXXIMA PART #	TRUCKLITE PART #	OPTRONICS PART #	GRAND GENERAL PART #	ROADMASTER PART #
TLED-419CR	38782 39643 39701	G4022	-	4051	STL513RCBP	76458	-
TLED-419R	-	-	-	4050	-	-	-
TLED-430R	-	54562 G4002 53312	M42320R	4050	-	78273	-
TLED-48CR	-	-	M42322RCL	-	-	-	1907-2RC
TLED-48R	38098	52922-3 53552-3 54332 54362 53252-3	M42322R M42346R M42365R	44302R	STL13RBP	77452 77456	-
TLED-48RG	38098	-	-	-	-	-	-
TLED-48RT	-	-	M42344R	44302R	-	-	-
TLED-4X40	36530	55162	M85416R	-	-	-	-
TLED-4X40F	-	55202	M85417R	-	-	-	-
TLED-4XRB	36529	-	-	-	-	-	-
TLED-B1A	-	-	M09320Y M09410Y	-	-	-	-
TLED-4X40F	-	55202	M85417R	-	-	-	-
TLED-4XRB	36529	-	-	-	-	-	-
TLED-B1A	-	-	M09320Y M09410Y	-	-	-	-
TLED-B1R	-	-	M09320R M09410R	-	-	-	-
TLED-B2A	37142	49323 49333	M09300Y M09400Y	33050Y	-	-	-
TLED-B2CA	37144	-	M09300YCL M09400YCL	-	-	-	-
TLED-B2CR	-	-	M09300RCL M09400RCL	-	-	-	-
TLED-B2R	-	49332 49322	M09300R M09400R	33050R 33265R	-	-	-
TLED-B3A	37967	49363	M09300YAT	-	-	-	-
TLED-B3CA	37969	-	-	-	-	-	-
TLED-B3R	-	49362	M09300RAS	-	-	-	-
TLED-B4A	-	47963 49383	-	-	-	-	-
TLED-B4R	-	47962 49382	-	-	-	-	-
TLED-BA	-	G4603	M23015Y	-	-	-	-
TLED-BA	-	G4603	M23015Y	-	-	-	-
TLED-BR	-	46792 G4602	M23015R	-	-	-	1826-2R
TLED-BX3AB	36840	-	-	-	-	-	-
TLED-BX3RB	36842	-	-	-	-	-	-
TLED-CAB	39527 39971	-	M27011Y	-	-	77568	1950A-L

CONTINUED ON NEXT PAGE

TRUX PART #	UNITED PACIFIC PART #	GROTE PART #	MAXXIMA PART #	TRUCKLITE PART #	OPTRONICS PART #	GRAND GENERAL PART #	ROADMASTER PART #
TLED-CAB2	39529 39996	-	M27011YCL	-	-	-	1950A
TLED-CABC	39528 39972	-	-	-	-	-	1950AC-L
TLED-CABC2	39530 39997	-	-	-	-	-	1950AC
TLED-DFF	38103 39438	G5300	M42341R/Y	-	-	-	-
TLED-F17A	-	-	M20343Y	-	-	-	-
TLED-F17CA	-	-	M20343YCL	-	-	-	-
TLED-F17CR	-	-	M20343RCL	-	-	-	-
TLED-F17R	-	-	M20343R	-	-	-	-
TLED-FLCA	38448	-	-	-	-	-	-
TLED-FLCAC	38449	-	-	-	-	-	-
TLED-FTLA	39486	47063	M20321Y M20361Y	-	-	-	1952A
TLED-FTLCA	39487	-	M20361YCL	-	-	-	-
TLED-FX78	-	-	M63318-A M63318R-A	-	-	-	-
TLED-G2A	-	45773 47953	M36180Y	-	-	79250	-
TLED-G2CA	-	47983	M36180YCL	-	-	79251	-
TLED-G2CR	-	47982	M36180RCL	-	-	-	-
TLED-G2R	-	45772 47952	M36180R	-	-	79255	-
TLED-G4A	36988	45583	M72270Y	00212355P	-	79460	-
TLED-G4CA	36990	-	M72270YCL	00212356P	-	79462	-
TLED-G4CR	-	-	M72270RCL	-	-	-	-
TLED-G4R	-	45582	M72270R	-	-	-	-
TLED-G4XCA	-	47772	-	-	-	-	-
TLED-G4XCR	-	47773	-	-	-	-	-
TLED-HOBA	38920	52193 54183 54193	M61321Y M63121Y	-	-	-	1925A
TLED-INF2A	-	47913	-	-	-	-	1814-1A
TLED-INF2CA	-	47923	-	-	-	-	-
TLED-INF2CR	-	47922	-	-	-	-	-
TLED-INF2R	-	47912	-	-	-	-	1814-1R
TLED-INFA	36988	-	M27005Y M20344 CH-Y	-	-	77830	1810-1A
TLED-INFCA	-	-	M27005YCL M20344 CH-YCL	-	-	77831	-
TLED-INFCR	-	-	M27005RCL M20344CH-RCL	-	-	-	-
TLED-INFR	-	-	M27005R M20344-RCL	-	-	77832	1810-1R
TLED-O12CR	38122	-	-	-	-	-	-
TLED-OBMA	39341	52183 53963 54133 54143 TUR5000Y-PG G6003	M63322Y M63420Y	6050A	-	87720	1919-1A

CONTINUED ON NEXT PAGE

TRUX INTERCHANGE

LED LIGHTING & ACCESSORIES

TRUX PART #	UNITED PACIFIC PART #	GROTE PART #	MAXXIMA PART #	TRUCKLITE PART #	OPTRONICS PART #	GRAND GENERAL PART #	ROADMASTER PART #
TLED-OBMCA	39342	-	M63322YCL	-	-	-	1919-2AC
TLED-OBMCR	-	-	M63322RCL	-	-	-	1919-2RC
TLED-OBMR	38121	52182 53962 54132 54142 54762 54722 54752 STT5000R-PG	M63322R M63346R M63420R	6058 6050	STL572RBP	77442 77053 87721	1919-1R
TLED-OBMW	-	62231 62601 62751	M63324 M63347	6060C	-	-	-
TLED-OX60R	-	54702 54627 54682	M85615R M85616R M63354-HYB	-	-	-	-
TLED-PA	-	-	M63122Y	-	-	-	-
TLED-PCAB	38152 38312 38313	-	-	-	-	-	1951A0L
TLED-PCAB2	38511 38517 39406 39823 39962 39964	45993	-	-	-	-	1951A
TLED-PCABC	38153 38461 38462	-	-	-	-	-	1951AC-L
TLED-PCABC2	38512 38518 39824 39963 39965	-	-	-	-	-	1951AC
TLED-PETA	38134	47253	M20332Y M30332Y	2673A	-	78565	1806-2A
TLED-PETCA	-	-	M20332YCL	-	-	-	1806-2AC
TLED-PETR	-	47252	M20332R M30332R	-	-	-	1806-2R
TLED-PSH	38396 38548 39436	-	-	-	-	-	-
TLED-PSHC	38397 38549 39437	-	-	-	-	-	-
TLED-SDXC	38758 38759 39379 39380	G5530 G5540	M42362RYCL-A M42363RYCL-A	-	-	-	-
TPIG-2W	-	67001-3 67050-3 PGT6710N-PG	M50950	94924	-	81010	-
TPIG-3W	-	67000-3 67090 PGT6700N-PG	M50900 M50911	-	-	80472 80783	-

CONTINUED ON NEXT PAGE

TRUX PART #	UNITED PACIFIC PART #	GROTE PART #	MAXXIMA PART #	TRUCKLITE PART #	OPTRONICS PART #	GRAND GENERAL PART #	ROADMASTER PART #
TPIG-L1	-	-	-	94706	-	-	-
TPIG-L2	-	-	M50904	-	-	-	-
TU-1005	-	-	M50905	-	-	-	-
TU-1007	-	-	PF-240	-	-	-	-
TU-1029	32352	-	-	-	-	-	-
TU-1029A	32346 32351	-	-	-	-	-	-
TU-1039	34205	-	M50914 M50915	-	-	-	-

UNIVERSAL ACCESSORIES

TRUX PART #	UNITED PACIFIC PART #	AMERICAN CHROME PART #	GRAND GENERAL PART #	ROADMASTER PART #	ROADWORKS PART #	FLEETLINE PART #	BETTS HD PART #	FLEET ENGINEERS PART #
THORN-1	46150 46151	23451	69988 69991	5020	-	-	-	-
THORN-2	46123 46130 46152	-	-	-	-	-	-	-
THORN-SV	-	-	69993	-	-	-	-	-
THUB-4N	-	16110 16112	10513	203	-	-	-	-
THUB-4NP	10146 20146	-	-	203-2	-	-	-	-
THUB-4NSS	20118	17023	-	203S	-	-	-	-
THUB-5N	-	-	10514	204	-	-	-	-
THUB-5NP	20147	-	-	-	-	-	-	-
THUB-5NSS	20094	-	-	204S	-	-	-	-
THUB-6N	10167	16252	10660	205	-	-	-	-
THUB-6NP	-	-	10700	-	-	-	-	-
THUB-6NSS	-	16253	10760	205S	-	-	-	-
THUB-834	-	16932 16930	20030	-	-	-	-	-
THUB-834P	10229 20190	16943	-	-	-	-	-	-
THUB-834SS	-	16933	-	-	-	-	-	-
THUB-858	10202C	-	20020	310	-	-	-	-
THUB-858P	10228	-	20130	310-2	-	-	-	-
THUB-858SS	20202	-	-	310SCD-2 310S	-	-	-	-
THUB-C1	10305	-	-	-	-	-	-	-
THUB-C4	10308	-	-	-	-	-	-	-
THUB-FRP112	-	15000	-	-	-	-	-	-
THUB-FRP33	10257	15100 15200	40134	217P	-	-	-	-
THUB-FRP33B	-	15105	-	-	-	-	-	-

CONTINUED ON NEXT PAGE

TRUX INTERCHANGE

UNIVERSAL ACCESSORIES

TRUX PART #	UNITED PACIFIC PART #	AMERICAN CHROME PART #	GRAND GENERAL PART #	ROADMASTER PART #	ROADWORKS PART #	FLEETLINE PART #	BETTS HD PART #	FLEET ENGINEERS PART #
THUB-RP33P	10278	-	-	-	-	-	-	-
THUB-RPN	-	15700	-	-	-	-	-	-
TM-2002	-	19061	33080 33081	4080S	-	-	-	-
TM-2003	-	19071	33250	4081S	-	-	-	-
TM-2004	-	19210	33323	4220S	-	-	-	-
TM-2007	86501B	-	-	-	-	-	-	-
TM-2008	-	-	33310	4115S	-	-	-	-
TM-2009	-	-	33101 33370	4125S	-	-	-	-
TM-2011	-	19101	-	4120S	-	-	-	-
TNUT-B2	10047	18013 18012 18010 18002	10011 10016 10039	-	-	-	-	-
TNUT-C1	10075	17801	-	111-60	-	-	-	-
TNUT-F1	-	17800 17802	10037 10265 10266	-	-	-	-	-
TNUT-F1SS	10081P	17803 17807	10272	-	-	-	-	-
TNUT-F2	10049B 10075	18200 18202 18210 18212 18300 18302	10276	111	-	-	-	-
TNUT-F2L	10117 10568	-	10258 10268	-	-	-	-	-
TNUT-F2T	10064B	18100 18102	-	111PFL	-	-	-	-
TNUT-F2TL	10034B	18350	10261	-	-	-	-	-
TNUT-P1	10569B	-	10264	-	-	-	-	-
TU-1030	-	23640	-	3005	-	-	-	-
TU-1031	10451	22170	30518	640	-	-	-	-
TU-1032	-	22171	-	640S	-	-	-	-
TU-1033	-	18400 18410	90252	100	-	-	-	-
TU-1037	-	15990	-	217P-T	-	-	-	-
TU-1714	-	20101	-	-	-	-	-	-
TU-1715	-	20101	-	-	-	-	-	-
TU-1716	21552	20103 20101	-	-	-	-	-	-
TU-9001L	34664	-	-	473S-3	0604B-02	-	-	-
TU-9001LC	34665	-	-	473S-4	-	-	-	-
TU-9008	-	21371	-	478S	-	-	-	-
TU-9204	-	14493	-	615S	-	-	-	-
TU-9209	-	21851	30171 30170	480S-SL	-	-	-	-

CONTINUED ON NEXT PAGE

TRUX PART #	UNITED PACIFIC PART #	AMERICAN CHROME PART #	GRAND GENERAL PART #	ROADMASTER PART #	ROADWORKS PART #	FLEETLINE PART #	BETTS HD PART #	FLEET ENGINEERS PART #
TU-9209L1	61726 62726	-	-	481S-SL-3	-	-	-	-
TU-9210	22301	-	-	-	-	-	-	-
TU-9210L1	62730	-	-	-	-	-	-	-
TU-9210LC	62731	-	-	-	-	-	-	-
TU-9214	10841 11310	21963 21961	30574	646S-SL	-	FF30SS-KIT	B703000NTSK	033-04993
TU-9215	10843	-	-	-	-	-	-	-
TU-9221	-	21990	30560	648-SL	-	-	-	-
TU-9222	-	22012	-	648B-SL	-	-	-	-
TU-9223	-	21991	30575	648S-SL	-	-	-	-
TU-9228	-	21992 22002	-	-	-	-	-	-
TU-9229	-	22001	-	647S-SL	-	-	-	-
TU-9232	10653	21965	30573	646-SL	-	-	B703000NTCK	-
TU-9233	-	21969 21962	-	646B-SL	-	-	-	-
TU-9242	-	14490	-	-	-	-	-	-
TU-9246	21409P 10416P	14513	30048	616SCD	10422	-	-	-
TU-9249	-	21900	-	-	-	-	-	-



PURPLE HAZE
2018 TRUX SHOW TRUCK

CONTINUED ON NEXT PAGE

TRUX INTERCHANGE

FENDERS

TRUX PART #	BETTS HD PART #	HOEGBUILT PART #	UNITED PACIFIC PART #	FLEETLINE PART #	MINIMIZER PART #	MERRITT PART #	FLEET ENGINEERS PART #	NULINE PART #	ROADMASTER PART #
TFEN-A12	-	MQ2012	10629	-	-	-	-	-	-
TFEN-A15	X2900	-	-	-	-	-	-	-	-
TFEN-A19	400118-01	-	-	-	-	-	-	-	-
TFEN-A29	B900S	-	-	-	-	-	-	-	-
TFEN-A30	B900S	-	-	-	-	-	-	-	-
TFEN-F10	-	5556	-	-	-	-	-	-	-
TFEN-F11	TS43905439	5506	-	3845-132	-	-	-	-	-
TFEN-F12	TS43905439	-	-	3445-132	-	5043-2	-	-	-
TFEN-F13	TS43505431	-	-	-	-	-	-	-	-
TFEN-F21	SR400-120	-	-	-	-	-	-	-	-
TFEN-F26	PF400-132X	-	-	5345-131	MIN900B	5343-2	-	-	-
TFEN-F40	-	-	-	-	MIN200	-	-	-	-
TFEN-FKIT	U400TS	-	-	4400-X	-	-	-	-	-
TFEN-FKITP2	K4362PS	-	-	4455-X	B4578BTSA	-	-	-	-
TFEN-H12	5040-2	-	-	3725-60	MA300-66	5040	034-02240	-	-
TFEN-H13	TS33503100	-	-	3725-66	-	-	-	-	-
TFEN-H20	-	BA500HT	-	3825-66	-	-	-	-	-
TFEN-H21	TSB3902700	-	-	-	-	-	-	-	-
TFEN-H32	SR300-60	-	-	-	-	-	-	N60SS	-
TFEN-H34	SR300-66	-	-	-	-	-	-	N66SS	-
TFEN-H35	GK33503100	-	-	-	-	-	-	-	-
TFEN-H37	SR300-80	-	-	-	-	-	-	N80SS	-
TFEN-H38	GR300-80	-	-	-	-	-	-	-	-
TFEN-H39	PF300-66	-	-	5325-66	MIN950	5340-2	-	-	-
TFEN-H50	-	BA505HT	-	-	-	-	-	-	-
TFEN-H52	-	BA510HT	-	-	-	-	-	-	-
TFEN-H53	-	BA510HT	-	-	-	-	-	-	-
TFEN-H57	-	BA510HT	-	-	-	-	-	-	-
TFEN-HKIT	U300TS	-	-	4200-X	-	-	-	-	-
TFEN-HKITP2	K3362PS	-	-	4255-X	B4850BTSA	-	-	-	-
TFEN-Q10	ST211PA2	M124	10808	1585PM24-KIT	-	-	031-00419	-	745S
TFEN-Q11	-	M127	10809	1585PM27-KIT	-	-	-	-	-
TFEN-Q12	-	-	10810	-	-	-	-	-	-
TFEN-Q13	-	M134	10624	1585PM35-KIT	-	-	-	-	-
TFEN-Q14	-	M130	10855	-	-	-	-	-	-
TFEN-Q17	SS211PA2	-	10585 10636	1585B-KIT	-	5070-2	031-01070	-	742S
TFEN-Q20	PS211PP2	-	10711	1900-KIT	MIN1400	5060-2	031-01636	-	-
TFEN-Q25	-	-	-	1585ELM-KIT	-	-	031-01074	-	-
TFEN-Q28	SS221PA2	-	-	1585ELMB-KIT	-	-	-	-	-
TFEN-S12	-	2706	-	3805-80	-	-	-	NF180SSNR	-
TFEN-S13	TS28000000	-	-	3705-80	-	5044-2	034-02241	-	-
TFEN-S17	PF200-80	-	-	5005-76	MIN2480B	5433-2	-	NF180PX	-

CONTINUED ON NEXT PAGE

TRUX PART #	BETTS HD PART #	HOEGBUILT PART #	UNITED PACIFIC PART #	FLEETLINE PART #	MINIMIZER PART #	MERRITT PART #	FLEET ENGINEERS PART #	NULINE PART #	ROADMASTER PART #
TFEN-S22	SR200-80	-	-	-	-	-	-	N180SS	-
TFEN-S37	-	2756 2710	-	-	-	-	-	-	-
TFEN-SKIT	L200TS	-	-	4000	-	-	-	-	-
TFEN-SKITP2	K2362PS	-	-	4055	B100BTSA	-	-	-	-



CODE BLUE
2019 TRUX SHOW TRUCK

TRUX INDEX

TRUX PART #	PAGE #	TRUX PART #	PAGE #	TRUX PART #	PAGE #	TRUX PART #	PAGE #	TRUX PART #	PAGE #
B607	118	TBEZ-2HCH4	113	TF-1104	276	TFEN-A64	179	TFEN-H63	165
B608	118	TBEZ-2HCH5	113	TF-1105	273	TFEN-F10	167	TFEN-H66	176
B609	118	TBEZ-4CH2	113	TF-1106	275	TFEN-F11	166	TFEN-HKIT	171
B610	118	TBEZ-4CH3	113	TF-1108	273	TFEN-F12	166	TFEN-HKIT2	171
B611	118	TBEZ-4CH4	113	TF-1109	271	TFEN-F13	167	TFEN-HKIT2HD	171
B612	118	TBEZ-4CH5	113	TF-1111	276	TFEN-F14	166	TFEN-HKITN	171
D604	117	TBEZ-4LR	114	TF-1203	276	TFEN-F15	168	TFEN-HKITP	177
D606	117	TBEZ-OBCH2	114	TF-1208	275	TFEN-F17	168	TFEN-HKITP2	177
D608	117	TBEZ-OBCH3	114	TF-1209	273	TFEN-F21	168	TFEN-HKITP3	177
D610	117	TBEZ-OBCH4	114	TF-1210	273	TFEN-F26	176	TFEN-Q10	156
D612	117	TBEZ-OBCH5	114	TF-1211	274	TFEN-F33	167	TFEN-Q11	157
S608	117	TBEZ-OLR	114	TF-1212	273	TFEN-F34	166	TFEN-Q12	158
S610	117	TBEZ-SQR	115	TF-1401	276	TFEN-F37	168	TFEN-Q13	157
S612	117	TCLA-103	197	TF-1405	270	TFEN-F40	176	TFEN-Q14	157
T604	118	TCLA-51	197	TF-1409	271	TFEN-F41	167	TFEN-Q17	155
T606	118	TCLA-61	197	TF-1410	271	TFEN-FKIT	171	TFEN-Q20	175
T608	118	TCLA-63	197	TF-1412	272	TFEN-FKIT2	171	TFEN-Q21	158
T610	118	TCLA-83	197	TF-1413	272	TFEN-FKIT2HD	171	TFEN-Q25	156
T612	118	TCLA-PEB	197	TF-1414	272	TFEN-FKITHD	171	TFEN-Q26	156
TB-C7W	112	TCLA-PEBA	197	TF-1422	274	TFEN-FKITN	171	TFEN-Q28	156
TB-F2A	110	TCLA73	197	TF-1427	274	TFEN-FKITP	178	TFEN-S10	170
TB-F2B	110	TEL-10	193	TF-1429	270	TFEN-FKITP2	178	TFEN-S11	169
TB-F2G	110	TEL-105	193	TF-1430	270	TFEN-FKITP3	178	TFEN-S12	169
TB-F2R	110	TEL-65	193	TF-1437	272	TFEN-H10	162	TFEN-S13	169
TB-F2W	110	TEL-75	193	TF-1454	271	TFEN-H11	162	TFEN-S14	170
TB-FCLIP	110	TEL-8	193	TF-1455	272	TFEN-H12	159	TFEN-S16	170
TB-FKIT	110	TEL-85	193	TF-1601	276	TFEN-H13	160	TFEN-S17	176
TB-S1156A	111	TEL55-PET	194	TF-1608	274	TFEN-H14	161	TFEN-S22	170
TB-S1156R	111	TEL65-PET	194	TF-1706	275	TFEN-H15	160	TFEN-S32	169
TB-S1156W	111	TEL75-PET	194	TFEN-A10	173	TFEN-H16	161	TFEN-S33	169
TB-S1157A	111	TEL85-PET	194	TFEN-A11	173	TFEN-H20	160	TFEN-S37	170
TB-S1157R	111	TF-1003	276	TFEN-A12	173	TFEN-H21	160	TFEN-SKIT	172
TB-S1157W	111	TF-1010	270	TFEN-A13	173	TFEN-H24	164	TFEN-SKITHD	172
TB-SP3037A	112	TF-1011	270	TFEN-A15	174	TFEN-H27	164	TFEN-SKITN	172
TB-SP3037B	112	TF-1015	269	TFEN-A17	174	TFEN-H29	164	TFEN-SKITP	177
TB-SP3037G	112	TF-1016	269	TFEN-A19	174	TFEN-H31	164	TFEN-SKITP2	178
TB-SP3037R	112	TF-1016LM	269	TFEN-A29	173	TFEN-H32	163	TFT-FLCAS	271
TB-SP3037W	112	TF-1016LMC	269	TFEN-A29	179	TFEN-H34	163	TFT-FLCAS3	271
TB-SP3156A	111	TF-1017	269	TFEN-A30	173	TFEN-H35	163	TFT-FLCOL	275
TB-SP3156R	111	TF-1018	269	TFEN-A30	179	TFEN-H37	163	TFT-KWT660	256
TB-SP3156W	111	TF-1018LM	269	TFEN-A36	174	TFEN-H38	163	TFT-KWT680	252
TB-SP3157A	111	TF-1018LMC	269	TFEN-A38	174	TFEN-H39	175	TFT-KWT680N	252
TB-SP3157R	111	TF-1019	269	TFEN-A44	174	TFEN-H50	161	TFT-MVIS	287
TB-SP3157W	111	TF-1020	269	TFEN-A53	180	TFEN-H52	162	TFT-PET379	229
TBEZ-2CH2	113	TF-1020LM	269	TFEN-A54	173	TFEN-H53	162	TFT-PET379F	229
TBEZ-2CH3	113	TF-1020LMC	269	TFEN-A54	179	TFEN-H54	160	TFT-PET389	231
TBEZ-2CH4	113	TF-1024	269	TFEN-A55	180	TFEN-H55	159	TFT-PET579	232
TBEZ-2CH5	113	TF-1025	269	TFEN-A58	173	TFEN-H57	162	TFT-VN	278
TBEZ-2HCH2	113	TF-1025LM	269	TFEN-A58	179	TFEN-H59	159	TGRO-2HR	115
TBEZ-2HCH3	113	TF-1025LMC	269	TFEN-A63	179	TFEN-H61	159	TGRO-2HRO	115

TRUX PART #	PAGE #	TRUX PART #	PAGE #	TRUX PART #	PAGE #	TRUX PART #	PAGE #	TRUX PART #	PAGE #
TGRO-2R	115	THORN-2	141	TK-1002	257	TK-1113	259	TK-13111LM	246
TGRO-2RC	115	THORN-D	141	TK-1003	257	TK-1114	259	TK-13111LMC	246
TGRO-4R	115	THORN-SV	141	TK-1032	242	TK-1115	260	TK-13112	246
TGRO-4RC	115	THUB-4N	131	TK-1033	242	TK-1119	250	TK-13112L	246
TGRO-OBR	115	THUB-4NP	131	TK-1034	242	TK-1121	250	TK-13112LC	246
TGRO-OBRC	115	THUB-4NSS	131	TK-1034LM	242	TK-1127	245	TK-13114	247
TGRO-SQR	115	THUB-5N	131	TK-1034LMC	242	TK-1133	252	TK-1318	247
THOD-FLCAS	267	THUB-5NP	131	TK-1035	242	TK-1134	262	TK-1368	247
THOD-FLCAS2	267	THUB-5NSS	131	TK-1035LM	242	TK-1140	260	TK-1368LM	247
THOD-FLCC	267	THUB-6N	131	TK-1035LMC	242	TK-1141	262	TK-1368LMC	247
THOD-FLCC2	267	THUB-6NP	131	TK-1037	243	TK-1143	252	TK-1370	247
THOD-FLCL	268	THUB-6NSS	131	TK-1038	243	TK-1144	252	TK-1370LM	247
THOD-FLCOL	267	THUB-712	132	TK-1038L	243	TK-1201	258	TK-1370LMC	247
THOD-FLCOR	268	THUB-834	132	TK-1038LC	243	TK-1202	258	TK-1377	246
THOD-FLCOR2	268	THUB-834P	132	TK-1055	242	TK-1203	258	TK-1377LM	246
THOD-FLD120	268	THUB-834SS	132	TK-1056	242	TK-1204	258	TK-1377LMC	246
THOD-IN40	282	THUB-834SS2003	132	TK-1057	242	TK-1205	260	TK-1387	246
THOD-IN92	283	THUB-858	132	TK-1057LM	242	TK-1206	260	TK-1387LM	246
THOD-IN93	283	THUB-858P	132	TK-1057LMC	242	TK-1208	261	TK-1387LMC	246
THOD-IN94	283	THUB-858SS	132	TK-1058	242	TK-1209	261	TK-1401	249
THOD-IN99	283	THUB-C1	119	TK-1058LM	242	TK-1210	261	TK-1402	249
THOD-INLS	282	THUB-C2	121	TK-1058LMC	242	TK-1211	256	TK-1406	262
THOD-INPR	282	THUB-C3	121	TK-1074	242	TK-1214	261	TK-1407	250
THOD-KW70	240	THUB-C4	119	TK-1074L	242	TK-1219	249	TK-1409	259
THOD-KW880	239	THUB-C5	122	TK-1074LC	242	TK-1224	260	TK-1419	259
THOD-KW900B	238	THUB-C6	122	TK-1086	242	TK-1225	260	TK-1427	254
THOD-KW900L	238	THUB-C7	120	TK-1086L	242	TK-1226	253	TK-1428	254
THOD-KWT2000	239	THUB-FRP	124	TK-1086LC	242	TK-1228	262	TK-1430	249
THOD-KWT300	240	THUB-FRP112	124	TK-1087	242	TK-1229	262	TK-1431	249
THOD-KWT600	239	THUB-FRP33	123	TK-1088	242	TK-1232	262	TK-1436	256
THOD-KWT660	239	THUB-FRP33B	124	TK-1088LM	242	TK-13100	241	TK-1438	254
THOD-KWT680	238	THUB-FRP33P	125	TK-1088LMC	242	TK-13101	241	TK-1451	253
THOD-KWT800	238	THUB-FRP33PO	123	TK-1089	242	TK-13101LM	241	TK-1501	246
THOD-MCH	286	THUB-FRPN	124	TK-1089L	242	TK-13101LMC	241	TK-1501	248
THOD-MGCT	286	THUB-FRPNP	125	TK-1089LC	242	TK-13102	241	TK-1502	246
THOD-PET335	203	THUB-RP	127	TK-1090	242	TK-13103	241	TK-1502	248
THOD-PET379	202	THUB-RP112	127	TK-1091	242	TK-13103L	241	TK-1502LM	246
THOD-PET386	202	THUB-RP33	126	TK-1091LM	242	TK-13103LC	241	TK-1502LM	248
THOD-PET387	204	THUB-RP33B	127	TK-1091LMC	242	TK-13104	241	TK-1502LMC	246
THOD-PET389	203	THUB-RP33P	128	TK-1092	242	TK-13105	241	TK-1502LMC	248
THOD-PET3K	202	THUB-RP33PO	126	TK-1092L	242	TK-13106	241	TK-1503	246
THOD-PET567	203	THUB-RPN	127	TK-1092LC	242	TK-13106LM	241	TK-1503	248
THOD-PET579	204	THUB-RPNP	128	TK-1093	243	TK-13106LMC	241	TK-1504	246
THOD-PET587	204	TI-1103	284	TK-1093L	243	TK-13107	241	TK-1504	248
THOD-VN	277	TI-1104	284	TK-1093LC	243	TK-13107L	241	TK-1504LM	246
THOD-WC	290	TI-1301	284	TK-1105	257	TK-13107LC	241	TK-1504LM	248
THOD-WCF	290	TI-1411	284	TK-1106	245	TK-13108	246	TK-1504LMC	246
THOD-WH	290	TI-1703	284	TK-1107	259	TK-13109	246	TK-1504LMC	248
THOD-WSB	290	TI-1708	284	TK-1110	258	TK-13110	246	TK-1513	246
THORN-1	141	TK-0108	261	TK-1111	257	TK-13111	246	TK-1513	248

TRUX INDEX

TRUX PART #	PAGE #	TRUX PART #	PAGE #	TRUX PART #	PAGE #	TRUX PART #	PAGE #	TRUX PART #	PAGE #
TK-1514	246	TK-1634	251	TLED-2HBA	86	TLED-419R	77	TLED-BX1AG	63
TK-1514	248	TK-1649	255	TLED-2HBR	86	TLED-419RF	78	TLED-BX1AP	63
TK-1514LM	246	TK-1651	253	TLED-2HR	85	TLED-430R	78	TLED-BX1AR	63
TK-1514LM	248	TK-1670	253	TLED-2HR1	311	TLED-48A	75	TLED-BX1AW	63
TK-1514LMC	246	TK-1671	253	TLED-2HTA	85	TLED-48CR	75	TLED-BX1RB	63
TK-1514LMC	248	TK-1672	253	TLED-2HTR	85	TLED-48R	75	TLED-BX1RG	63
TK-1515	246	TK-1680	254	TLED-2HXAB	66	TLED-48R1	313	TLED-BX1RP	63
TK-1515	248	TK-1681	254	TLED-2HXAG	66	TLED-48RG	75	TLED-BX1RW	63
TK-1565	246	TK-1682	242	TLED-2HXAP	66	TLED-48RT	75	TLED-BX3AB	62
TK-1565	248	TK-1682LM	242	TLED-2HXCA	86	TLED-4X40	55	TLED-BX3AG	62
TK-1565L	246	TK-1682LMC	242	TLED-2HXCR	86	TLED-4X401	314	TLED-BX3AP	62
TK-1565L	248	TK-1702	257	TLED-2HXRB	66	TLED-4X40A	59	TLED-BX3AR	62
TK-1565LC	246	TK-1704	256	TLED-2HXRG	66	TLED-4X40AS	54	TLED-BX3AW	62
TK-1565LC	248	TK-1712	254	TLED-2HXRP	66	TLED-4X40F	55	TLED-BX3RB	62
TK-1566	246	TK-1814	244	TLED-2HXRW	66	TLED-4X40G	55	TLED-BX3RG	62
TK-1566	248	TK-1814LM	244	TLED-2R	83	TLED-4X40T	55	TLED-BX3RP	62
TK-1566L	246	TK-1814LMC	244	TLED-2R1	310	TLED-4X40W	59	TLED-BX3RW	62
TK-1566L	248	TK-1815	244	TLED-2TA	83	TLED-4XAB	59	TLED-BX40	56
TK-1566LC	246	TK-1815LM	244	TLED-2TR	83	TLED-4XAG	59	TLED-BX4AB	64
TK-1566LC	248	TK-1815LMC	244	TLED-2X6A	95	TLED-4XRB	59	TLED-BX4AR	64
TK-1578	246	TK-1844	244	TLED-2X6AB	71	TLED-4XRBF	60	TLED-BX4AW	64
TK-1578	248	TK-1844LM	244	TLED-2X6CA	95	TLED-4XRG	59	TLED-BX4RB	64
TK-1578L	246	TK-1844LMC	244	TLED-2X6CR	95	TLED-4XRGF	60	TLED-BX4RW	64
TK-1578L	248	TK-1845	244	TLED-2X6DA	95	TLED-4XRP	59	TLED-CAB	92
TK-1578LC	246	TK-1845LM	244	TLED-2X6DCA	95	TLED-4XRPF	60	TLED-CAB2	92
TK-1578LC	248	TK-1845LMC	244	TLED-2X6DCR	95	TLED-B1A	82	TLED-CAB2XAB	70
TK-1579	246	TK-1848	244	TLED-2X6DR	95	TLED-B1CA	82	TLED-CAB2XAG	70
TK-1579	248	TK-1848L	244	TLED-2X6R	95	TLED-B1CR	82	TLED-CAB2XAP	70
TK-1579LM	246	TK-1848LC	244	TLED-2X6RA	94	TLED-B1R	82	TLED-CABC	92
TK-1579LM	248	TK-1852	244	TLED-2X6RB	71	TLED-B2A	81	TLED-CABC2	92
TK-1579LMC	246	TK-1852L	244	TLED-2X6RR	94	TLED-B2A1	309	TLED-DFC2	103
TK-1579LMC	248	TK-1852LC	244	TLED-2X6SA	94	TLED-B2CA	81	TLED-DFC3	104
TK-1580	246	TK-1853	244	TLED-2X6SCA	94	TLED-B2CR	81	TLED-DFCC2	103
TK-1580	248	TK-1853L	244	TLED-2XA	84	TLED-B2R	81	TLED-DFCC3	104
TK-1580L	246	TK-1853LC	244	TLED-2XAB	65	TLED-B2R1	309	TLED-DFF	103
TK-1580L	248	TK-1858	244	TLED-2XAG	65	TLED-B3A	81	TLED-DFO	104
TK-1580LC	246	TK-1858L	244	TLED-2XAP	65	TLED-B3CA	81	TLED-DFXB	73
TK-1580LC	248	TK-1858LC	244	TLED-2XAR	65	TLED-B3CR	81	TLED-DFXG	73
TK-1600	261	TK-1901	258	TLED-2XCA	84	TLED-B3R	81	TLED-DFXP	73
TK-1601	261	TLED-012A	79	TLED-2XCR	84	TLED-B4A	80	TLED-F17A	101
TK-1602	255	TLED-1X2A	94	TLED-2XR	84	TLED-B4CA	80	TLED-F17CA	101
TK-1603	255	TLED-1X2R	94	TLED-2XRB	65	TLED-B4CR	80	TLED-F17CR	101
TK-1609	250	TLED-1X4A	94	TLED-2XRG	65	TLED-B4R	80	TLED-F17R	101
TK-1616	251	TLED-1X4R	94	TLED-2XRP	65	TLED-B5A	81	TLED-F17W	101
TK-1617	251	TLED-2A	83	TLED-2XRW	65	TLED-B5CA	81	TLED-F2A	84
TK-1618	251	TLED-2A1	310	TLED-4100A	77	TLED-B5CR	81	TLED-F2CA	84
TK-1620	255	TLED-2BA	86	TLED-4100R	77	TLED-B5R	81	TLED-F2CR	84
TK-1621	255	TLED-2BR	86	TLED-4100W	77	TLED-BA	96	TLED-F2R	84
TK-1630	251	TLED-2HA	85	TLED-419CR	77	TLED-BR	96	TLED-F45A	102
TK-1631	251	TLED-2HA1	311	TLED-419CRF	78	TLED-BX1AB	63	TLED-F45CA	102

TRUX PART #	PAGE #	TRUX PART #	PAGE #	TRUX PART #	PAGE #	TRUX PART #	PAGE #	TRUX PART #	PAGE #
TLED-F45R	102	TLED-G2XCA	89	TLED-GL48CP	109	TLED-H63	18	TLED-PETR	97
TLED-F4CR	79	TLED-G2XCR	89	TLED-GL48CR	109	TLED-H66	05	TLED-PSH	97
TLED-F4R	79	TLED-G2XR	89	TLED-GL48CW	109	TLED-H67	05	TLED-PSHC	97
TLED-F4R1	79	TLED-G2XRB	68	TLED-GL48SA	109	TLED-H68	05	TLED-PSHXB	71
TLED-F4RCR1	79	TLED-G2XRG	68	TLED-GL48SB	109	TLED-H69	05	TLED-PSHXG	71
TLED-F9A	101	TLED-G2XRP	68	TLED-GL48SG	109	TLED-H7	14	TLED-PSHXP	71
TLED-F9CA	101	TLED-G2XRW	68	TLED-GL48SP	109	TLED-H70	21	TLED-SA	110
TLED-F9R	101	TLED-G4A	87	TLED-GL48SR	109	TLED-H71	17	TLED-SDX	105
TLED-FD	104	TLED-G4A1	312	TLED-GL48SW	109	TLED-H73	14	TLED-SDXB	74
TLED-FDC	104	TLED-G4CA	87	TLED-H1	15	TLED-H74	19	TLED-SDXC	105
TLED-FG2A	90	TLED-G4CR	87	TLED-H104	03	TLED-H75	14	TLED-SDXG	74
TLED-FG2CA	90	TLED-G4R	87	TLED-H105	03	TLED-H77	21	TLED-SDXP	74
TLED-FG2CR	90	TLED-G4XA	89	TLED-H106	03	TLED-HOBA	96	TLED-SOBA	96
TLED-FG2R	90	TLED-G4XAB	67	TLED-H107	03	TLED-INF2A	93	TLED-SR	110
TLED-FG3A	98	TLED-G4XAG	67	TLED-H11	11	TLED-INF2CA	93	TLED-SXAB	72
TLED-FG3CA	98	TLED-G4XAP	67	TLED-H11	317	TLED-INF2CR	93	TLED-SXAG	72
TLED-FG3CR	98	TLED-G4XAW	67	TLED-H12	11	TLED-INF2R	93	TLED-SXAP	72
TLED-FG3R	98	TLED-G4XCA	89	TLED-H12	317	TLED-INF2A	93	TLED-SXAR	72
TLED-FG4A	102	TLED-G4XCR	89	TLED-H120	01	TLED-INFCA	93	TLED-SXRB	72
TLED-FG4CA	102	TLED-G4XR	89	TLED-H121	01	TLED-INFCR	93	TLED-SXRG	72
TLED-FG4CR	102	TLED-G4XRB	67	TLED-H122	01	TLED-INFR	93	TLED-SXRP	72
TLED-FG4R	102	TLED-G4XRG	67	TLED-H123	01	TLED-O12CA	79	TLED-TLA	96
TLED-FGA	90	TLED-G4XRP	67	TLED-H13	07	TLED-O12CR	79	TLED-TLR	96
TLED-FGCA	90	TLED-GL12CA	107	TLED-H14	07	TLED-O12R	79	TLED-U1	37
TLED-FGCR	90	TLED-GL12CB	107	TLED-H15	07	TLED-OBMA	80	TLED-U10	41
TLED-FGR	90	TLED-GL12CG	107	TLED-H16	07	TLED-OBMCA	80	TLED-U102	26
TLED-FLA1	49	TLED-GL12CP	107	TLED-H17	09	TLED-OBMCR	80	TLED-U103	26
TLED-FLA1X	49	TLED-GL12CR	107	TLED-H18	09	TLED-OBMR	80	TLED-U104	31
TLED-FLCA	99	TLED-GL12CW	107	TLED-H19	09	TLED-OBMW	80	TLED-U104	315
TLED-FLCAC	99	TLED-GL12SA	107	TLED-H2	15	TLED-OX60A	61	TLED-U105	32
TLED-FPA	99	TLED-GL12SB	107	TLED-H20	09	TLED-OX60AS	54	TLED-U106	30
TLED-FPCA	99	TLED-GL12SG	107	TLED-H3	21	TLED-OX60R	56	TLED-U107	30
TLED-FS	105	TLED-GL12SP	107	TLED-H39	05	TLED-OX60RAS	54	TLED-U108	43
TLED-FSC	105	TLED-GL12SR	107	TLED-H4	19	TLED-OXAB	61	TLED-U112	28
TLED-FTLA	99	TLED-GL12SW	107	TLED-H42	05	TLED-OXAG	61	TLED-U114	28
TLED-FTLCA	99	TLED-GL24CA	108	TLED-H43	05	TLED-OXAP	61	TLED-U116	25
TLED-FX106	71	TLED-GL24CB	108	TLED-H44	05	TLED-OXAR	61	TLED-U118	27
TLED-FX72	57	TLED-GL24CG	108	TLED-H45	09	TLED-OXRB	61	TLED-U120	24
TLED-FX73	57	TLED-GL24CP	108	TLED-H46	09	TLED-OXRG	61	TLED-U122	31
TLED-FX76	57	TLED-GL24CR	108	TLED-H49	07	TLED-OXRP	61	TLED-U122	316
TLED-FX78	57	TLED-GL24CW	108	TLED-H5	17	TLED-PA	99	TLED-U16	44
TLED-G2A	88	TLED-GL24SA	108	TLED-H50	07	TLED-PCAB	92	TLED-U17	44
TLED-G2CA	88	TLED-GL24SB	108	TLED-H51	22	TLED-PCAB2	92	TLED-U18	35
TLED-G2CR	88	TLED-GL24SG	108	TLED-H52	20	TLED-PCAB2XAB	70	TLED-U19	38
TLED-G2R	88	TLED-GL24SP	108	TLED-H54	09	TLED-PCAB2XAG	70	TLED-U2	34
TLED-G2XA	89	TLED-GL24SR	108	TLED-H55	09	TLED-PCAB2XAP	70	TLED-U20	42
TLED-G2XAB	68	TLED-GL24SW	108	TLED-H56	18	TLED-PCABC	92	TLED-U21	42
TLED-G2XAG	68	TLED-GL48CA	109	TLED-H57	07	TLED-PCABC2	92	TLED-U22	42
TLED-G2XAP	68	TLED-GL48CB	109	TLED-H58	07	TLED-PETA	97	TLED-U25	38
TLED-G2XAW	68	TLED-GL48CG	109	TLED-H6	14	TLED-PETCA	97	TLED-U26	35

TRUX INDEX

TRUX PART #	PAGE #	TRUX PART #	PAGE #	TRUX PART #	PAGE #	TRUX PART #	PAGE #	TRUX PART #	PAGE #
TLED-U27	35	TLED-WXAB	69	TNUT-F2TL	130	TP-10145	224	TP-10174LM	223
TLED-U28	38	TLED-WXAG	69	TNUT-F2TP	129	TP-10146	224	TP-10174LMC	223
TLED-U29	39	TLED-WXAP	69	TNUT-P1	130	TP-10147	224	TP-10175	223
TLED-U32	33	TLED-WXAR	69	TP-0130	225	TP-10148	224	TP-10175LM	223
TLED-U33	33	TLED-WXAW	69	TP-0196	225	TP-10149	224	TP-10175LMC	223
TLED-U34	36	TLED-WXRB	69	TP-1001	228	TP-10149LM	224	TP-10177	222
TLED-U35	36	TLED-WXRG	69	TP-1003	210	TP-10149LMC	224	TP-10178	222
TLED-U36	50	TLED-WXRP	69	TP-1005	210	TP-10150	224	TP-10179	222
TLED-U4	38	TLED-WXRW	69	TP-1007	209	TP-10150LM	224	TP-10179LM	222
TLED-U40	42	TLED-X1A	100	TP-1009	209	TP-10150LMC	224	TP-10179LMC	222
TLED-U47	49	TLED-X1B	100	TP-10107	218	TP-10151	224	TP-10180	221
TLED-U49	43	TLED-X1G	100	TP-10107LF	218	TP-10151LM	224	TP-10181	222
TLED-U5	35	TLED-X1R	100	TP-10107LFC	218	TP-10151LMC	224	TP-10182	222
TLED-U50	50	TLED-X3A	100	TP-10114	222	TP-10152	224	TP-10183	222
TLED-U6	32	TLED-X3B	100	TP-10115	222	TP-10152LM	224	TP-10183LM	222
TLED-U65	51	TLED-X3G	100	TP-10115LM	222	TP-10152LMC	224	TP-10183LMC	222
TLED-U66	51	TLED-X3R	100	TP-10115LMC	222	TP-10153	223	TP-10195	210
TLED-U67	51	TM-1101	286	TP-10116	222	TP-10154	223	TP-10195L	210
TLED-U68	51	TM-1102	285	TP-10116LM	222	TP-10155	223	TP-10195LC	210
TLED-U69	51	TM-1107	286	TP-10116LMC	222	TP-10155LM	223	TP-10215	218
TLED-U76	52	TM-1109	288	TP-10120	221	TP-10155LMC	223	TP-10215L	218
TLED-U77	52	TM-1110	288	TP-10120LM	221	TP-10156	223	TP-10215LC	218
TLED-U8	39	TM-1202	287	TP-10120LMC	221	TP-10156LM	223	TP-10220	210
TLED-U86	52	TM-1403	288	TP-10127	219	TP-10156LMC	223	TP-10220L	210
TLED-U87	36	TM-1412	286	TP-10127LLM	219	TP-10157	223	TP-10220LC	210
TLED-U88	36	TM-1413	288	TP-10127LMC	219	TP-10158	223	TP-10221	210
TLED-U89	33	TM-1417	285	TP-10130	221	TP-10159	223	TP-10221L	210
TLED-U9	39	TM-1427	286	TP-10130LM	221	TP-10159LM	223	TP-10221LC	210
TLED-U90	33	TM-1429	288	TP-10130LMC	221	TP-10159LMC	223	TP-1062	209
TLED-U93	34	TM-1605	287	TP-10131	221	TP-10160	221	TP-1062LM	209
TLED-U94	34	TM-1606	287	TP-10131LM	221	TP-10161	221	TP-1062LMC	209
TLED-U95	37	TM-1801	287	TP-10131LMC	221	TP-10162	221	TP-1063	210
TLED-U96	37	TM-1802	287	TP-10133	221	TP-10163	221	TP-1063LM	210
TLED-U97	40	TM-2002	154	TP-10133LM	221	TP-10163LM	221	TP-1063LMC	210
TLED-U98	40	TM-2003	154	TP-10133LMC	221	TP-10163LMC	221	TP-1064	209
TLED-W1	45	TM-2008	153	TP-10138	220	TP-10164	221	TP-1064LM	209
TLED-W13A24	47	TM-2009	153	TP-10138LM	220	TP-10164LM	221	TP-1064LMC	209
TLED-W14A26	47	TM-2011	153	TP-10138LMC	220	TP-10164LMC	221	TP-1065	210
TLED-W16A26	47	TM-24	144	TP-10140	222	TP-10165	221	TP-1065LM	210
TLED-W2	45	TM-30	144	TP-10140LM	222	TP-10165LM	221	TP-1065LMC	210
TLED-W23A24	48	TNUT-B1	130	TP-10140LMC	222	TP-10165LMC	221	TP-1066	210
TLED-W24A26	48	TNUT-B2	129	TP-10142	222	TP-10166	221	TP-1066LM	210
TLED-W26A26	48	TNUT-C1	129	TP-10142LM	222	TP-10168	220	TP-1066LMC	210
TLED-W3	29	TNUT-C4	129	TP-10142LMC	222	TP-10170	223	TP-1067	210
TLED-W4	29	TNUT-F1	130	TP-10143	222	TP-10171	223	TP-1067LM	210
TLED-W5	46	TNUT-F1SS	130	TP-10143LM	222	TP-10172	223	TP-1067LMC	210
TLED-WA	91	TNUT-F2	129	TP-10143LMC	222	TP-10173	223	TP-1090	210
TLED-WCA	91	TNUT-F2L	129	TP-10144	223	TP-10173LM	223	TP-1091	210
TLED-WCR	91	TNUT-F2T	130	TP-10144LM	223	TP-10173LMC	223	TP-1092	210
TLED-WR	91	TNUT-F2TB	130	TP-10144LMC	223	TP-10174	223	TP-1093	210

TRUX PART #	PAGE #
TP-1102	228
TP-1104	228
TP-1109	207
TP-1112	230
TP-1113	230
TP-1119	229
TP-1123	233
TP-1124	202
TP-1125	202
TP-1128	234
TP-1129	232
TP-1131	204
TP-1139	203
TP-1143	227
TP-1144	227
TP-1201	229
TP-1210	230
TP-1211	230
TP-1218	232
TP-1219	229
TP-1228	230
TP-1301	208
TP-1302	208
TP-1302L	208
TP-1302LC	208
TP-1303	208
TP-1303LM	208
TP-1303LMC	208
TP-1304	207
TP-1305	207
TP-1305L	207
TP-1305LC	207
TP-1306	207
TP-1306LM	207
TP-1306LMC	207
TP-1310	214
TP-13100	213
TP-13101	214
TP-13102	215
TP-13110	208
TP-13110L	208
TP-13110LC	208
TP-13116	215
TP-13116L	215
TP-13116LC	215
TP-13120	213
TP-13120L	213
TP-13120LC	213
TP-13121	214
TP-13121L	214

TRUX PART #	PAGE #
TP-13121LC	214
TP-13126	207
TP-13126L	207
TP-13126LC	207
TP-13149	214
TP-13150	214
TP-13159	214
TP-13159LM	214
TP-13159LMC	214
TP-13166	215
TP-13166LM	215
TP-13166LMC	215
TP-13167	215
TP-13167L	215
TP-13167LC	215
TP-13168	214
TP-13168LM	214
TP-13168LMC	214
TP-13169	214
TP-13169L	214
TP-13169LC	214
TP-13170	214
TP-13170L	214
TP-13170LC	214
TP-13171	215
TP-1396	213
TP-1396LM	213
TP-1396LMC	213
TP-1397	215
TP-1397LM	215
TP-1397LMC	215
TP-1398	214
TP-1398LM	214
TP-1398LMC	214
TP-1401	225
TP-1402	225
TP-1407	225
TP-1413	227
TP-1431	225
TP-1433	233
TP-1434	232
TP-1436	226
TP-1437	226
TP-1438	226
TP-1439	226
TP-1440	234
TP-1440	254
TP-1444	234
TP-1445	234
TP-1446	226

TRUX PART #	PAGE #
TP-1501	208
TP-1501	208
TP-1502	208
TP-1502L	208
TP-1502LC	208
TP-1503	208
TP-1503	208
TP-1503LM	208
TP-1503LM	208
TP-1503LMC	208
TP-1503LMC	208
TP-1504	208
TP-1504	208
TP-1505	208
TP-1505L	208
TP-1505LC	208
TP-1506	208
TP-1506	208
TP-1506LM	208
TP-1506LM	208
TP-1506LMC	208
TP-1506LMC	208
TP-1510	208
TP-1510	208
TP-1511	208
TP-15118	217
TP-15118LM	217
TP-15118LMC	217
TP-15119	217
TP-15119LM	217
TP-15119LMC	217
TP-1511L	208
TP-1511LC	208
TP-1512	208
TP-1512	208
TP-15120	216
TP-15120LM	216
TP-15120LMC	216
TP-15128	208
TP-15128L	208
TP-15128LC	208
TP-15129	209
TP-15129L	209
TP-15129LC	209
TP-1512LM	208
TP-1512LM	208
TP-1512LMC	208
TP-1512LMC	208
TP-1513	209
TP-15132	208

TRUX PART #	PAGE #
TP-15132L	208
TP-15132LC	208
TP-15137	217
TP-15139	216
TP-15139L	216
TP-15139LC	216
TP-1514	209
TP-15140	209
TP-15140	217
TP-15140L	209
TP-15140L	217
TP-15140LC	209
TP-15140LC	217
TP-1514L	209
TP-1514LC	209
TP-1515	209
TP-15152	215
TP-15152L	215
TP-15152LC	215
TP-15156	215
TP-15156L	215
TP-15156LC	215
TP-15158	215
TP-15159	216
TP-1515LM	209
TP-1515LMC	209
TP-1516	209
TP-15160	216
TP-15162	217
TP-15163	217
TP-1517	209
TP-1517L	209
TP-1517LC	209
TP-1518	209
TP-15185	217
TP-15185LM	217
TP-15185LMC	217
TP-1518LM	209
TP-1518LMC	209
TP-15200	217
TP-15200L	217
TP-15200LC	217
TP-15201	216
TP-15201L	216
TP-15201LC	216
TP-15203	217
TP-15203LM	217
TP-15203LMC	217
TP-15204	216
TP-15204LM	216

TRUX PART #	PAGE #
TP-15204LMC	216
TP-15205	216
TP-15205LM	216
TP-15205LMC	216
TP-15207	215
TP-15207LM	215
TP-15207LMC	215
TP-15208	215
TP-15208LM	215
TP-15208LMC	215
TP-15209	216
TP-15210	216
TP-15210L	216
TP-15210LC	216
TP-15211	215
TP-15212	215
TP-15212L	215
TP-15212LC	215
TP-15213	216
TP-15214	215
TP-15215	215
TP-15215L	215
TP-15215LC	215
TP-15216	217
TP-1571	216
TP-1571LM	216
TP-1571LMC	216
TP-1583	215
TP-1585	215
TP-1585LM	215
TP-1585LMC	215
TP-1588	215
TP-1588LM	215
TP-1588LMC	215
TP-1595	217
TP-1602	226
TP-1606	231
TP-1622B	227
TP-1643	233
TP-1645	227
TP-1646	233
TP-1648	233
TP-1651	227
TP-1662	227
TP-1662T	227
TP-1701	231
TP-1702	231
TP-1703	231
TP-1801	205
TP-1801L	205

TRUX INDEX

TRUX PART #	PAGE #	TRUX PART #	PAGE #	TRUX PART #	PAGE #	TRUX PART #	PAGE #	TRUX PART #	PAGE #
TP-1801LC	205	TP-1822	212	TP-1864L	212	TRX-121	299	TRX-228	301
TP-1803	206	TP-1822L	206	TP-1864LC	206	TRX-122	299	TRX-233	320
TP-1803L	206	TP-1822L	212	TP-1864LC	212	TRX-123	323	TRX-234	320
TP-1803LC	206	TP-1822LC	206	TP-1865	211	TRX-124	299	TRX-235	56
TP-1805	206	TP-1822LC	212	TP-1865L	211	TRX-130	303	TRX-235	85
TP-1805L	206	TP-1840	205	TP-1865LC	211	TRX-131	298	TRX-235	311
TP-1805LC	206	TP-1840	212	TP-1866	212	TRX-132	297	TRX-236	85
TP-1808	205	TP-1840LM	205	TP-1866L	212	TRX-133	297	TRX-236	311
TP-1808	211	TP-1840LM	212	TP-1866LC	212	TRX-134	301	TRX-237	87
TP-1808L	205	TP-1840LMC	205	TP-1867	212	TRX-135	31	TRX-237	314
TP-1808L	211	TP-1840LMC	212	TP-1867L	212	TRX-135	315	TRX-238	312
TP-1808LC	205	TP-1846	211	TP-1867LC	212	TRX-136	76	TRX-239	31
TP-1808LC	211	TP-1846L	211	TP-1868	206	TRX-136	313	TRX-239	316
TP-1809	206	TP-1846LC	211	TP-1868	212	TRX-140	82	TRX-240	317
TP-1809	212	TP-1847	211	TP-1868LM	206	TRX-140	309	TRX-241	317
TP-1809L	206	TP-1847L	211	TP-1868LM	212	TRX-142	82	TRX-244	321
TP-1809L	212	TP-1847LC	211	TP-1868LMC	206	TRX-142	309	TRX-245	321
TP-1809LC	206	TP-1852	205	TP-1868LMC	212	TRX-143	298	TRX-246	321
TP-1809LC	212	TP-1852	211	TP-2010	197	TRX-144	297	TSK-5Y	197
TP-1810	206	TP-1852LM	205	TPIG-2W	116	TRX-157	318	TSK-8Y	197
TP-1810	212	TP-1852LM	211	TPIG-3W	116	TRX-158	318	TSK10-52S	192
TP-1810L	206	TP-1852LMC	205	TPIG-H1	116	TRX-159	318	TSK10-55S	192
TP-1810L	212	TP-1852LMC	211	TPIG-L1	116	TRX-160	318	TSK10-B54T	191
TP-1810LC	206	TP-1853	211	TPIG-L2	116	TRX-165	301	TSK10-B60T	191
TP-1810LC	212	TP-1853LM	211	TRX-012	319	TRX-167	307	TSK10-BSET	186
TP-1812	206	TP-1853LMC	211	TRX-014	319	TRX-168	307	TSK10-BSET2	186
TP-1812LM	206	TP-1854	212	TRX-029	320	TRX-169	302	TSK10-BSET3	186
TP-1812LMC	206	TP-1854LM	212	TRX-054	319	TRX-170	302	TSK10-BSET4	186
TP-1814	205	TP-1854LMC	212	TRX-063	322	TRX-171	297	TSK10-C54T	191
TP-1814L	205	TP-1855	205	TRX-067	321	TRX-172	308	TSK10-C60T	191
TP-1814LC	205	TP-1855	212	TRX-068	321	TRX-173	308	TSK10-CSET	186
TP-1816	206	TP-1855LM	205	TRX-070	321	TRX-178	318	TSK10-CSET3	186
TP-1816L	206	TP-1855LM	212	TRX-071	321	TRX-186	306	TSK10-CSET4	186
TP-1816LC	206	TP-1855LMC	205	TRX-072	319	TRX-187	306	TSK10-F54T	191
TP-1818	206	TP-1855LMC	212	TRX-076	306	TRX-190	306	TSK10-F60T	191
TP-1818L	206	TP-1857	206	TRX-078	304	TRX-191	318	TSK10-FSET	186
TP-1818LC	206	TP-1857	212	TRX-079	305	TRX-200	320	TSK10-FSET2	186
TP-1820	205	TP-1857LLMC	206	TRX-084	321	TRX-201	320	TSK10-FSET3	186
TP-1820	211	TP-1857LM	206	TRX-089	299	TRX-202	320	TSK10-FSET4	186
TP-1820L	205	TP-1857LM	212	TRX-090	299	TRX-203	320	TSK10-M54T	191
TP-1820L	211	TP-1857LMC	212	TRX-091	304	TRX-204	320	TSK10-M60T	191
TP-1820LC	205	TP-1863	205	TRX-092	305	TRX-205	320	TSK10-MSET	186
TP-1820LC	211	TP-1863	211	TRX-093	305	TRX-206	320	TSK10-MSET2	186
TP-1821	206	TP-1863L	205	TRX-094	303	TRX-208	320	TSK10-MSET2	186
TP-1821	212	TP-1863L	211	TRX-100	318	TRX-209	319	TSK10-MSET3	186
TP-1821L	206	TP-1863LC	205	TRX-102	299	TRX-214	320	TSK10-MSET4	186
TP-1821L	212	TP-1863LC	211	TRX-103	321	TRX-223	83	TSK10K	198
TP-1821LC	206	TP-1864	206	TRX-105	319	TRX-223	310	TSK5-B036	195
TP-1821LC	212	TP-1864	212	TRX-112	308	TRX-224	83	TSK5-B048	195
TP-1822	206	TP-1864L	206	TRX-113	307	TRX-224	310	TSK5-B060	195

TRUX PART #	PAGE #
TSK5-C036	195
TSK5-C048	195
TSK5-C060	195
TSK5-M036	195
TSK5-M048	195
TSK5-M060	195
TSK5K	198
TSK6-52S	192
TSK6-55S	192
TSK6-B54T	191
TSK6-B60T	191
TSK6-BSET	182
TSK6-BSET2	182
TSK6-BSET3	188
TSK6-BSET4	188
TSK6-BSET5	184
TSK6-BSET6	184
TSK6-BSET7	190
TSK6-BSET8	190
TSK6-C54T	191
TSK6-C60T	191
TSK6-CSET	182
TSK6-CSET2	182
TSK6-CSET3	188
TSK6-CSET4	188
TSK6-CSET5	184
TSK6-CSET6	184
TSK6-CSET7	190
TSK6-CSET8	190
TSK6-M54T	191
TSK6-M60T	191
TSK6-MSET	182
TSK6-MSET2	182
TSK6-MSET3	188
TSK6-MSET4	188
TSK6-MSET5	184
TSK6-MSET6	184
TSK6-MSET7	190
TSK6-MSET8	190
TSK65-52S	192
TSK65-B036	196
TSK65-B048	196
TSK65-B060	196
TSK65-C036	196
TSK65-C048	196
TSK65-C060	196
TSK65-M036	196
TSK65-M048	196
TSK65-M060	196
TSK6K	198

TRUX PART #	PAGE #
TSK7-52S	192
TSK7-55S	192
TSK7-B54T	191
TSK7-B60T	191
TSK7-BSET	182
TSK7-BSET2	182
TSK7-BSET3	188
TSK7-BSET4	188
TSK7-BSET5	184
TSK7-BSET6	184
TSK7-BSET7	190
TSK7-BSET8	190
TSK7-C54T	191
TSK7-C60T	191
TSK7-CSET	182
TSK7-CSET2	182
TSK7-CSET3	188
TSK7-CSET4	188
TSK7-CSET5	184
TSK7-CSET6	184
TSK7-CSET7	190
TSK7-CSET8	190
TSK7-M54T	191
TSK7-M60T	191
TSK7-MSET	182
TSK7-MSET2	182
TSK7-MSET3	188
TSK7-MSET4	188
TSK7-MSET5	184
TSK7-MSET6	184
TSK7-MSET7	190
TSK7-MSET8	190
TSK75-52S	192
TSK75-55S	192
TSK75-B048	196
TSK75-B060	196
TSK75-C048	196
TSK75-C060	196
TSK75-M048	196
TSK75-M060	196
TSK7K	198
TSK8-52S	192
TSK8-55S	192
TSK8-B54T	191
TSK8-B60T	191
TSK8-BSET	182
TSK8-BSET2	182
TSK8-BSET3	184
TSK8-BSET4	184
TSK8-BSET5	188

TRUX PART #	PAGE #
TSK8-BSET6	188
TSK8-BSET7	190
TSK8-BSET8	190
TSK8-C54T	191
TSK8-C60T	191
TSK8-CSET	182
TSK8-CSET2	182
TSK8-CSET3	184
TSK8-CSET4	184
TSK8-CSET5	188
TSK8-CSET6	188
TSK8-CSET7	190
TSK8-CSET8	190
TSK8-F54T	191
TSK8-F60T	191
TSK8-FSET	182
TSK8-FSET2	182
TSK8-FSET3	188
TSK8-FSET4	184
TSK8-FSET5	184
TSK8-FSET6	188
TSK8-FSET7	190
TSK8-FSET8	190
TSK8-M54T	191
TSK8-M60T	191
TSK8-MSET	182
TSK8-MSET2	182
TSK8-MSET3	184
TSK8-MSET4	188
TSK8-MSET5	184
TSK8-MSET6	188
TSK8-MSET7	190
TSK8-MSET8	190
TSK8K	198
TSUN-F1	265
TSUN-F17	264
TSUN-F19	264
TSUN-F2	265
TSUN-F21	264
TSUN-F24	263
TSUN-F25	263
TSUN-F26	263
TSUN-F27	266
TSUN-F28	266
TSUN-F3	265
TSUN-F32	263
TSUN-F37	263
TSUN-F4	265
TSUN-F6	264
TSUN-F70	263

TRUX PART #	PAGE #
TSUN-F71	263
TSUN-F8	264
TSUN-I1	281
TSUN-I10	282
TSUN-I11	282
TSUN-I12	282
TSUN-I18	282
TSUN-I2	281
TSUN-I5	281
TSUN-I7	281
TSUN-I8	281
TSUN-I9	281
TSUN-K1	235
TSUN-K11	236
TSUN-K12	236
TSUN-K13	235
TSUN-K14	235
TSUN-K2	235
TSUN-K20	237
TSUN-K21	237
TSUN-K22	237
TSUN-K23	237
TSUN-K4	235
TSUN-K45	237
TSUN-K5	236
TSUN-K6	235
TSUN-K8	236
TSUN-M1	285
TSUN-M2	285
TSUN-M3	285
TSUN-P1	199
TSUN-P11	201
TSUN-P14	199
TSUN-P17	201
TSUN-P2	199
TSUN-P20	200
TSUN-P24	200
TSUN-P25	199
TSUN-P26	199
TSUN-P27	201
TSUN-P28	200
TSUN-P30	200
TSUN-P57	201
TSUN-P8	201
TSUN-V1	277
TSUN-V2	277
TSUN-W1	289
TSUN-W2	289
TSUN-W3	289
TSUN-W8	289

TRUX PART #	PAGE #
TT-100	296
TT-101	296
TT-102	296
TT-1032XL	294
TT-103L	294
TT-103M	294
TT-103XL	294
TT-1042XL	294
TT-104L	294
TT-104M	294
TT-104XL	294
TT-1052XL	294
TT-105L	294
TT-105M	294
TT-105XL	294
TT-1062XL	295
TT-106L	295
TT-106M	295
TT-106XL	295
TT-1072XL	295
TT-107L	295
TT-107M	295
TT-107XL	295
TT-1082XL	295
TT-108L	295
TT-108M	295
TT-108XL	295
TT-109	296
TU-1005	116
TU-1007	112
TU-1029	98
TU-1029A	98
TU-1029W	98
TU-1030	142
TU-1031	144
TU-1032	144
TU-1033	130
TU-1037	130
TU-1039	116
TU-1043	01
TU-1043	114
TU-1045	03
TU-1046	50
TU-1047	50
TU-1048	50
TU-1049	50
TU-1050	50
TU-1051	50
TU-1400	142
TU-1601	151

TRUX INDEX

TRUX PART #	PAGE #
TU-1601L	151
TU-1601L2	152
TU-1601L3	152
TU-1601L4	152
TU-1601L5	152
TU-1601LC	151
TU-1714	142
TU-1715	142
TU-1716	142
TU-9001	145
TU-9001L	145
TU-9001L2	146
TU-9001L3	146
TU-9001L4	146
TU-9001L5	146
TU-9001L6	146
TU-9001LC	145
TU-9002	147
TU-9002L	147
TU-9002L2	148
TU-9002L3	148
TU-9002L4	148
TU-9002L5	148
TU-9002L6	148
TU-9002LC	147
TU-9008	150
TU-9008L	150
TU-9008LC	150
TU-9013L	150
TU-9013LC	150
TU-9017	149
TU-9017L1	149
TU-9017L2	149
TU-9017L4	149
TU-9017LC	149
TU-9204	143
TU-9208	144
TU-9209	133
TU-9209L1	133
TU-9209L2	134
TU-9209L3	134
TU-9209L4	134
TU-9209L5	134
TU-9209L6	134
TU-9209LC	133
TU-9210	135
TU-9210L1	135
TU-9210L2	136
TU-9210L3	136
TU-9210L4	136

TRUX PART #	PAGE #
TU-9210L5	136
TU-9210L6	136
TU-9210LC	135
TU-9214	140
TU-9215	140
TU-9217	137
TU-9217L	137
TU-9217LC	137
TU-9221	139
TU-9222	139
TU-9223	139
TU-9224	140
TU-9225	140
TU-9226	140
TU-9227	139
TU-9228	139
TU-9229	139
TU-9230	138
TU-9231	138
TU-9232	140
TU-9233	140
TU-9239	143
TU-9241	143
TU-9242	143
TU-9245	138
TU-9245LF	138
TU-9245LFC	138
TU-9245LFC2	138
TU-9246	143
TU-9248	138
TU-9249	138
TU-9250	138
TU-9258	137
TU-9259	137
TV-1002	280
TV-1102	278
TV-1103	278
TV-1104	278
TV-1203	278
TV-1404	277
TV-1406	279
TV-1408	279
TV-1413	280
TV-1415	280
TV-1421	279
TV-1436	279
TV-1440	280
TV-1462	280
TV-1701	278
TW-1101	291

TRUX PART #	PAGE #
TW-1105	291
TW-1203	291
TW-1207	291
TW-1401	292
TW-1404	292
TW-1407	292
TW-1411	292

**VISIT OUR WEBSITE
FOR NEW & INNOVATIVE PRODUCTS**



TRUXACCESSORIES.COM



**ON A BREAK?
KEEP UP TO DATE
ON ALL THINGS TRUX**



Facebook
facebook.com/GOTRUX/



Twitter
@gotrux



Instagram
@truxaccessories



Issuu.com
issuu.com/truxaccessories

BE ORIGINAL



1-888-950-2227
TRUXACCESSORIES.COM